



Member of the **Katadyn Group**

PARTS IDENTIFICATION MANUAL

SYSTEM TYPE	PAGE NO.
<u>Current Production & Post 2014 Systems</u>	
<u>Non-Automated</u>	
Ventura Deluxe.....	2
Cape Horn Xtreme.....	6
<u>Automated Systems</u>	
Circuit Boards, Sensors and Valves.....	9
Ventura MPC & Connect.....	11
Bimini 300 Connect.....	13
Catalina 340 Connect & MKII-Z.....	19
Newport Connect & MK-IIZ Series.....	24
Farallon 1800/2800.....	38
<u>2009-2014 MKII Systems</u>	
Catalina 300 MkII.....	51
Newport 400 MkII.....	55
Newport 700/1000 MkII.....	59
<u>Pre-2009 Systems</u>	
Catalina 300 MPC.....	65
Catalina 300 Deluxe.....	69
Newport 700/1000 MKI.....	70
Newport Mag.....	75
Monterey.....	78
Santa Cruz.....	84
Gulfstream.....	87
<u>Clark Pump</u>	
Exploded Views.....	93
<u>06/35/40/80 Survivor Series</u>	
Power Survivor 40E Pump.....	97
Manual Excerpts.....	101

Updated November 2020

Ventura Deluxe



Plate Bracket
FM-PVB-PB

3/8" NPT x 5/8" NPT Hose Barb Ell Nylon
PL-HBE-3/8x5/8

Pump to Pressure Vessel
Upper SS Tube:
PL-TB-HPTPVUS

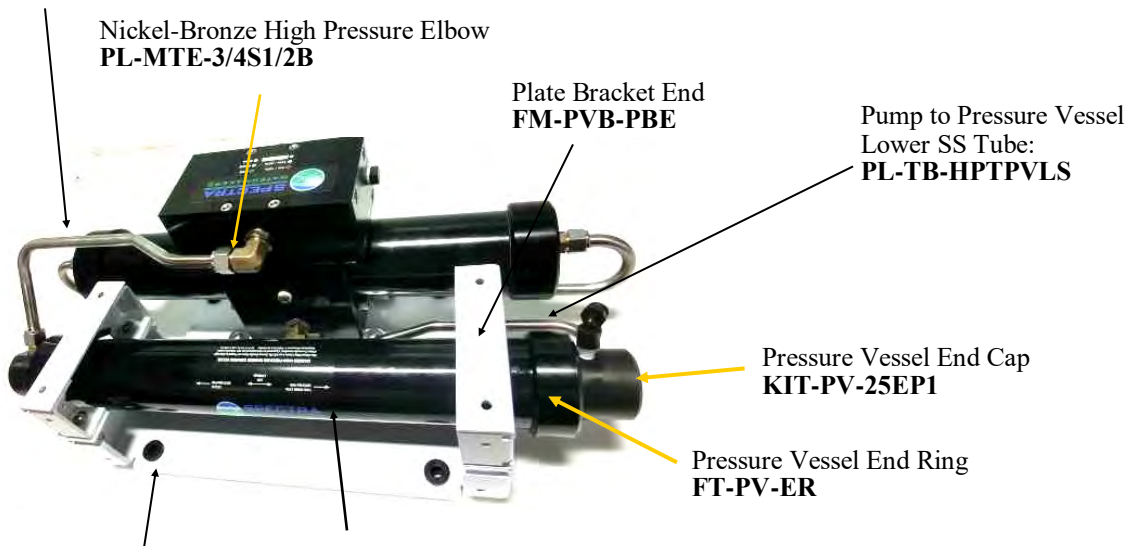

Nickel-Bronze High Pressure Elbow
PL-MTE-3/4S1/2B

Plate Bracket End
FM-PVB-PBE

Pump to Pressure Vessel
Lower SS Tube:
PL-TB-HPTPVLS

Pressure Vessel End Cap
KIT-PV-25EP1

Pressure Vessel End Ring
FT-PV-ER

Rubber Mount
HD-RBP-RM
Plastic Spacer
HD-SPN-MKINS

20-Inch Hi Rejection Membrane
FT-MB-20F



Valve End Block B
HP-TB-VEB-B

Stroke Sensor
EL-MPC-SC15
(OLDER MODELS ONLY)

3/8" NPT Quick Disc. Coupling
Body

5/8" Quick Disc. Fitting
Hose Barb

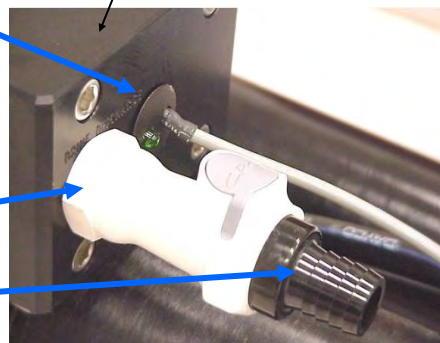

SUB-CT-Z-HPILHA
CT 340 Z Quick Disconnect

Ventura Deluxe

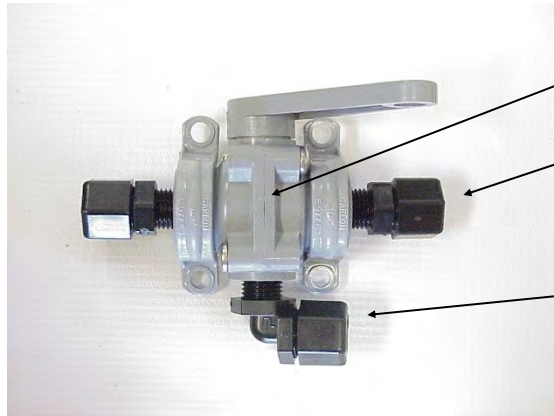

PRODUCT WATER
SAMPLING VALVE
PL-VLV-3W1/4

1/4 TUBE X 1/4 MPT
STRAIGHT FITTING
PL-MTS-1/4X1/4J

1/4 TUBE X 1/4 MPT EL
PL-MTE-1/4X1/4P

ACCUMULATOR
PL-ACC-TK

1/2NPT X 5/8 HOSE
BARB **PL-HBS-1/2X5/8**

1/2" TEE
PL-TEE-1/2FN

1/2" NIPPLE
PL-NP-1/2N



1/8MPT X 1/4 TUBE EL
PL-MTE-1/8X1/4P

PRODUCT FLOW METER
PL-FMT-10

1/4NPT X 1/4 TUBE
STRAIGHT FITTING
PL-MTS-1/4X1/4J

1/2 X 1/4 BUSHING
PL-BSH-1/2X1/4N

**SPECTRA PANEL ASSEMBLY 200 GPD
SUB-MD-PNLA200**

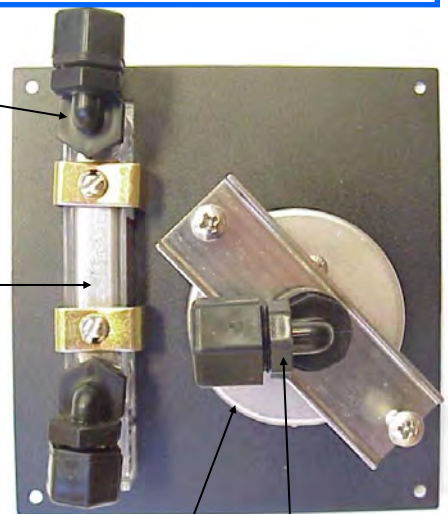

PRESSURE GAUGE
PL-PSG-LP2.5

PREFILTER HOUSING
FT-FTH-10H

5 MICRON FILTER
CARTRIDGE
FT-FTC-5



PRODUCT OUTLET
FITTING
PL-FTE-1/8X1/4P

NIPPLE
PL-NP-1/8N

1/4FPT X 1/4 TUBE
ELBOW
PL-FTE-1/4X1/4P

Ventura Deluxe

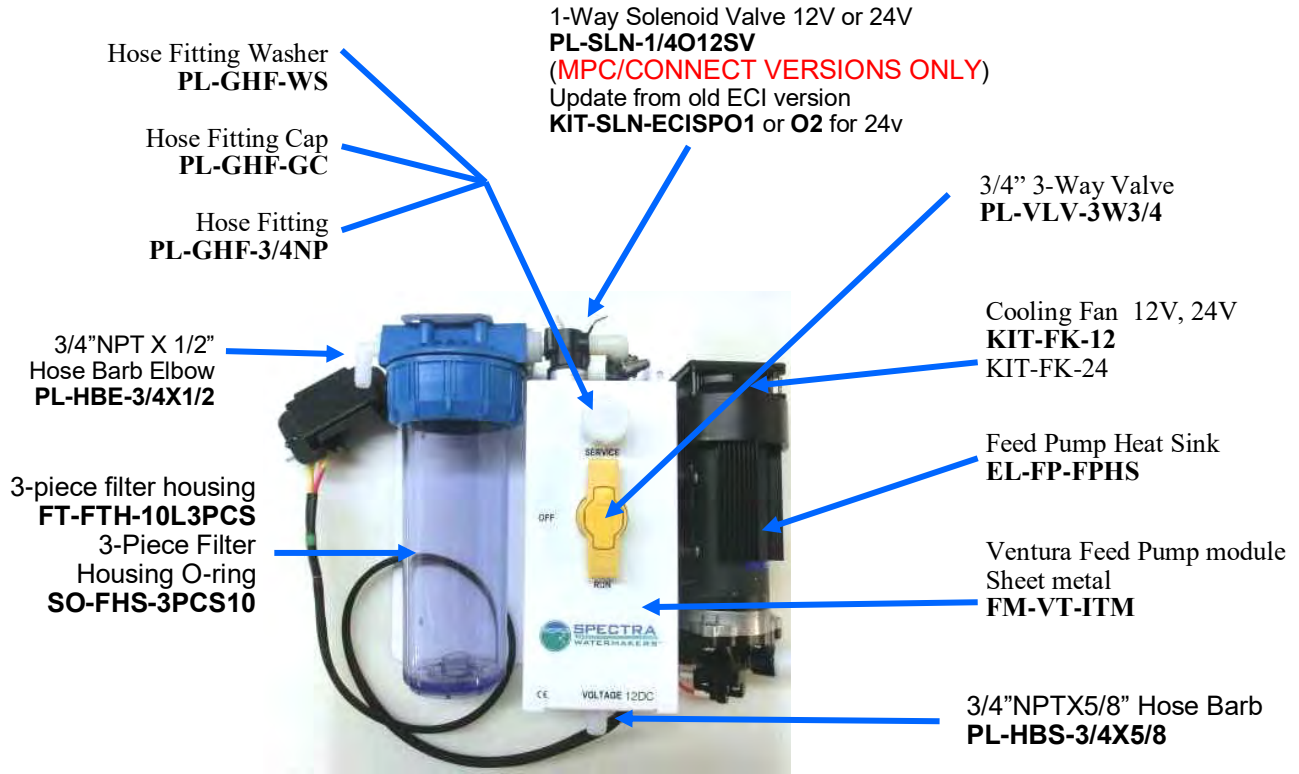

Flush Valve
PL-VLV-3/4PVC (MANUAL/DELUXE VERSIONS)



SEA STRAINER
FT-STN-5

5" STRAINER O-RING
SO-STN-5SS

STRAINER SCREEN
FT-STN-5S

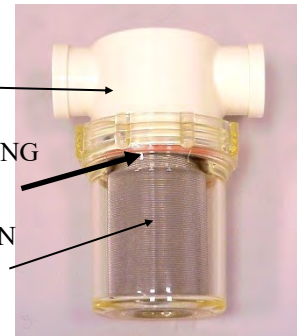

Pump Head Assembly W/Press. Switch
PL-PMP-SFPH



Feed Pump 12V, 24V
EL-FP-12V, 24V

3/8" NPT X 5/8" Hose Barb El.
PL-HBE-3/8X5/8

Feed Pump Pressure Switch
KIT-FP-SFSK



Ventura Deluxe cont.

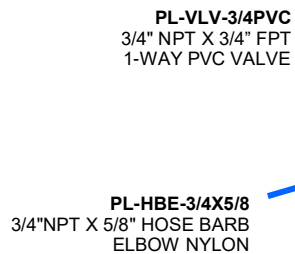
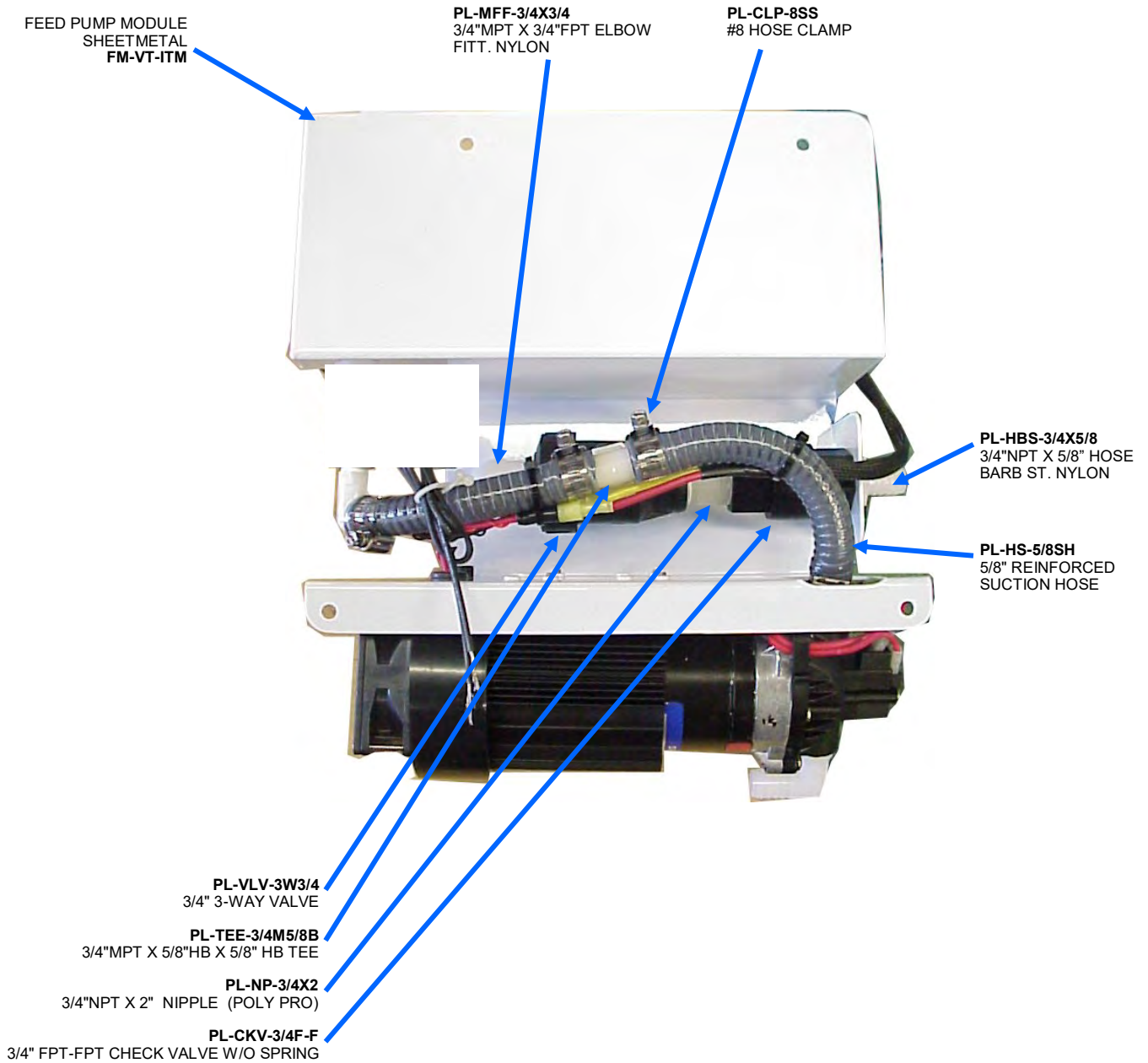

Cape Horn Xtreme

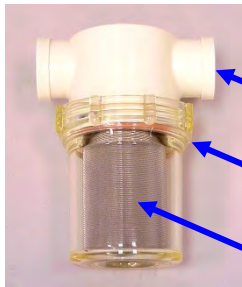
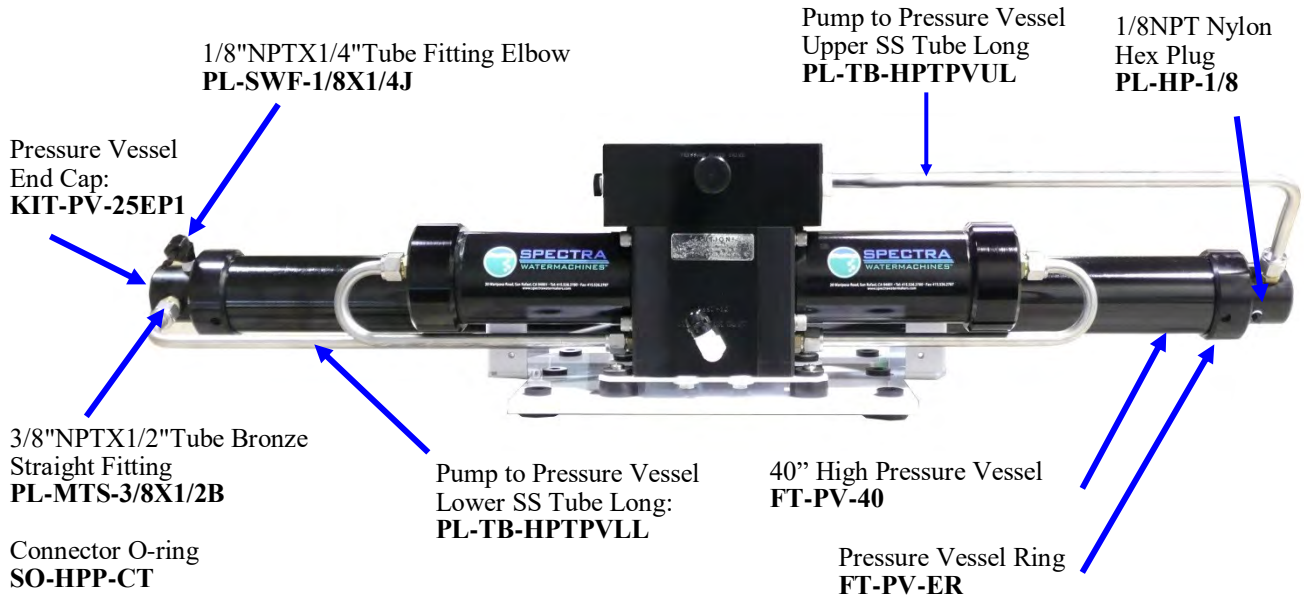

Sea Strainer (Complete Assembly)
FT-STN-5

Strainer Seal
SO-STN-5SS

Strainer Screen
FT-STN-5S

Spectra Panel Assembly 400 GPD
SUB-MD-PNLA380

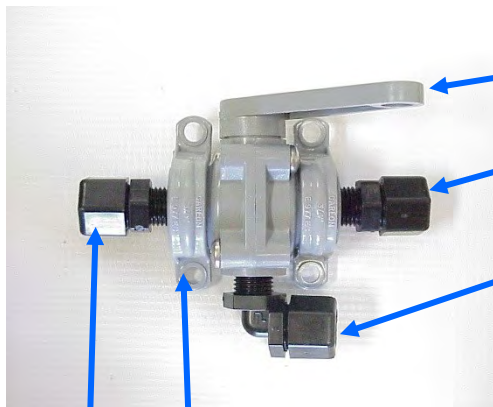

1/4" 3-Way Valve
PL-VLV-3W1/4

1/4"NPTX1/4"Tube Fitting
PL-MTS-1/4X1/4J

1/4"NPTX1/4" Tube Fitting El.
PL-MTE-1/4X1/4P

3/4" Clamp
PL-CLP-3/4CAR

1/4"NPTX1/4"Tube Fitting
PL-MTS-1/4X1/4J

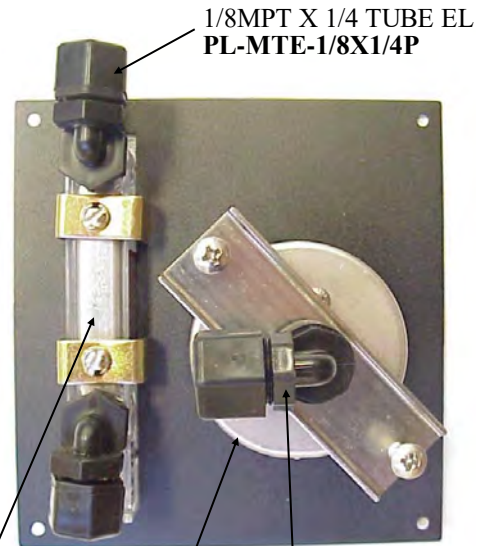

1/8MPT X 1/4 TUBE EL
PL-MTE-1/8X1/4P

Pressure Gauge
PL-PSG-LP2.5

Product Flow Meter
PL-FMT-20

1/4FPT X 1/4 TUBE
ELBOW
PL-FTE-1/4X1/4P

Cape Horn Xtreme

3/8" NPT Quick Disc. Coupling Body
PL-QDC-BD3/8

5/8" Quick Disc. Fitting Hose Barb
PL-QDC-HB5/8

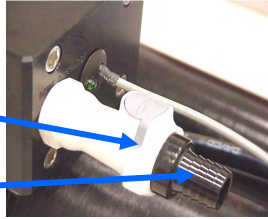

Accumulator Tank
PL-ACC-TK

1/2" NPT X 5/8
 Hose Barb
PL-HBS-1/2X5/8

1/2" X 1/4" Bushing
 Reducer
PL-BSH-1/2X1/4N

Pump to Pressure Vessel
 Upper SS Tube:
PL-TB-HPTPVUL

1/2" Nipple
PL-NP-1/2N

1/2" Female Tee
PL-TEE-1/2FN

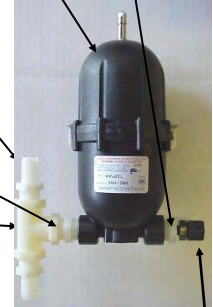

Nickel-Bronze High Pressure Elbow
PL-MTE-3/4S1/2B

Pump to Pressure Vessel
 Lower SS Tube:
PL-TB-HPTPVLL

1/4 MPT X 1/4 TUBE
 Straight Fitting
PL-MTE-1/4X1/4J

Plate Bracket End Cap
FM-PVB-PBE

Nickel-Bronze High
 Pressure Straight Fitting
SUB-MTS-3/8X1/2

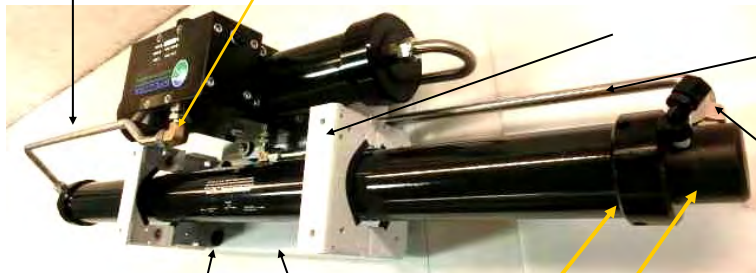

Rear View

Plate Bracket
FM-PVB-PB

Pressure Vessel
 End Cap
KIT-PV-25EP1

3/4"-16 Straight Thread
 O-RING
SO-FT-STF

Rubber Mount
HD-RBP-RM

Pressure Vessel End Ring
FT-PV-ER

1/2" Stainless Ferrule
PL-HWR-1/2FR

Plastic Spacer
HD-SPN-MKINS

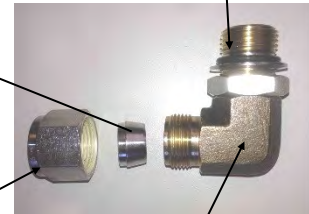

Complete assembly
PL-MTS-3/8X1/2B

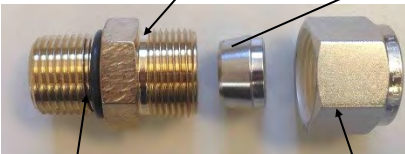

Connector O-RING
SO-HPP-CT

Stainless Fitting Hex Nut
PL-HWR-1/2HN

Nickel-bronze high pres-
 sure 90 degree fitting
PL-MTE-3/4S1/2B

Cape Horn Xtreme

Feed Pump Module A, w/ charcoal filter for fresh water flushes



Feed Pump Module B:



Feed Pump 12V, 24V
EL-FP-12V, 24V

3/8"NPT X 5/8" Hose Barb El.
PL-HBE-3/8X5/8

Feed Pump Pressure Switch
EL-FP-PS

Pump Head Assembly W/Press. Switch
PL-PMP-SFPH



Valves and Sensors



Rotoflo Meters

EL-SSR-IFM INLINE FLOW SENSOR (0.5-5)

Two male 3/8" NPT fittings, Used on Catalina and Newport Models



EL-SSR-IFMLR INLINE FLOW METER (0.1-2 L/M)

Two male 1/4" NPT fittings. Used on Ventura Models



Salinity Probe

EL-MPC-SP4 SALINITY PROBE 4TH GENERATION

Marked SP4. Used on all Connect & MPC Systems (Version A34 and up) Reads TDS and Temperature. Responsible for Poor Water Quality & Salinity Probe Failed alarms.



Pressure Sensors

EL-SSR-ABS ABSOLUTE PRESSURE SENSOR

*Marked CP2-132. Comes with **yellow band**. Responsible for boost pressure and prefilter condition.*



EL-SSR-150 PRESSURE TRANSDUCER (150 PSI)

*Marked CP2-130. Responsible for feed pressure, and high pressure alarm. Ventura Models have two, one with **red band** and one a **green band**. Catalina and Newport 400 Models have one with a **red band***



EL-SSR-250 PRESSURE TRANSDUCER (250 PSI)

*Marked CP2-131. Responsible for feed pressure, and high pressure alarm. Newport 700 and 1000 Models have one with **red band***



Solenoid Valves

PL-SLN-1/4D12M 1/4" DIVERSION VALVE 12 V (MNF)

**Burkert brand diversion valve. Without power sends water back to feed stream. Manual override button used to send water to tank*



EL-TM-BKVC BURKERT SOLENOID VALVE CONNECTOR

Electrical Connector for solenoid valve

PL-SLN-1/4O12SP 1/4 2-WAY SOLENOID 12V SPAR W/O VBD

Freshwater flush solenoid. Holds ships pressurized water system (50 psi max). On all Newport systems since June 2015.



PL-SLN-1/4O12SV 1/4"FPT 2W SOLENOID SPART.12V W/VBD

Freshwater flush solenoid with two 1/4" female NPT fittings. Holds ships pressurized water system (50 psi max). On all Ventura and Catalina systems since June 2015.



Alcon or ECI "round" Solenoids

These valves were used until June of 2015 when they were discontinued. The valve bodies are still available however, retrofit kits are necessary for valve replacements.

PL-SLN-1/4VB 1/4" 3-WAY SOLENOID VALVE BODY

Plumbing portion of solenoid. Two 1/4" female NPT fittings and mounting holes



PL-SLN-1/4D12 - **Discontinued**

USE KIT-MNF-BURDV12 DIVERSION VALVE MANIFOLD CONVERSION

*Note: Above conforms to current production quality standards. In some situations, **KIT-SLN-ECISPD1** ECI TO SPARTON DIV. VALVE KIT may be used in the field in its place.*



PL-SLN-1/4O12 - **Discontinued**

Use **KIT-SLN-ECISPO1** ECI TO SPARTON 1-W VALVE KIT 12V if replacing round ECI or Alcon brand solenoid. Or use **PL-SLN-1/4O12SV** if existing valve body will not be reused/is damaged.



Spectra Connect

Circuit Board, Relays, and Display Panels

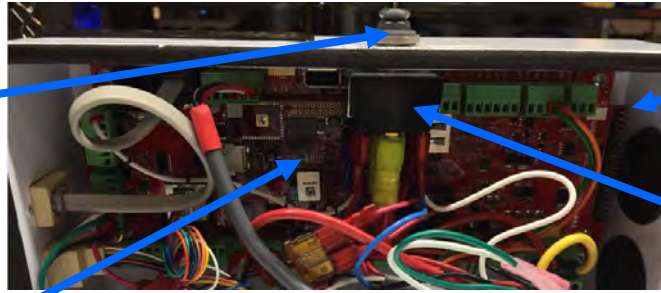

EL-SWT-TSBHC
TOGGLE SWITCH BOOT
SEAL

FM-MPC-MPCB
MPC BOX

EL-SWT-TG-DPDT
TOGGLE SWITCH
DP/DT

EL-SC-CTRBA SPECTRA
CONNECT CONTROL
BOARD ASSM (RLB+CPU)

EL-RL-40A12 12V, 40A CUBE RELAY or
EL-RL-40A24 24V, 40A CUBE RELAY
-Voltage specific, one per system, not shown

*****NOTE: SPECIFY
SYSTEM MODEL
ON PURCHASE
ORDER. VENTURA
SYSTEMS
REQUIRE
FIRMWARE v1.8
OR LATER*****



EL-SC-100DPC 100'
SPECTRA CONNECT
REMOTE DISPLAY
CABLE

KIT-SC-RMPNLL SPECTRA CONNECT REMOTE CNTRL. DSP.4.3"(LOCAL)



KIT-SC-RMPNL SPECTRA CON-
NECT REMOTE CNTRL.
DISP.4.3" (REMOTE, comes with
100' of cabling)
KIT-SC-RMPNLD Display Only

Ventura Connect & MPC

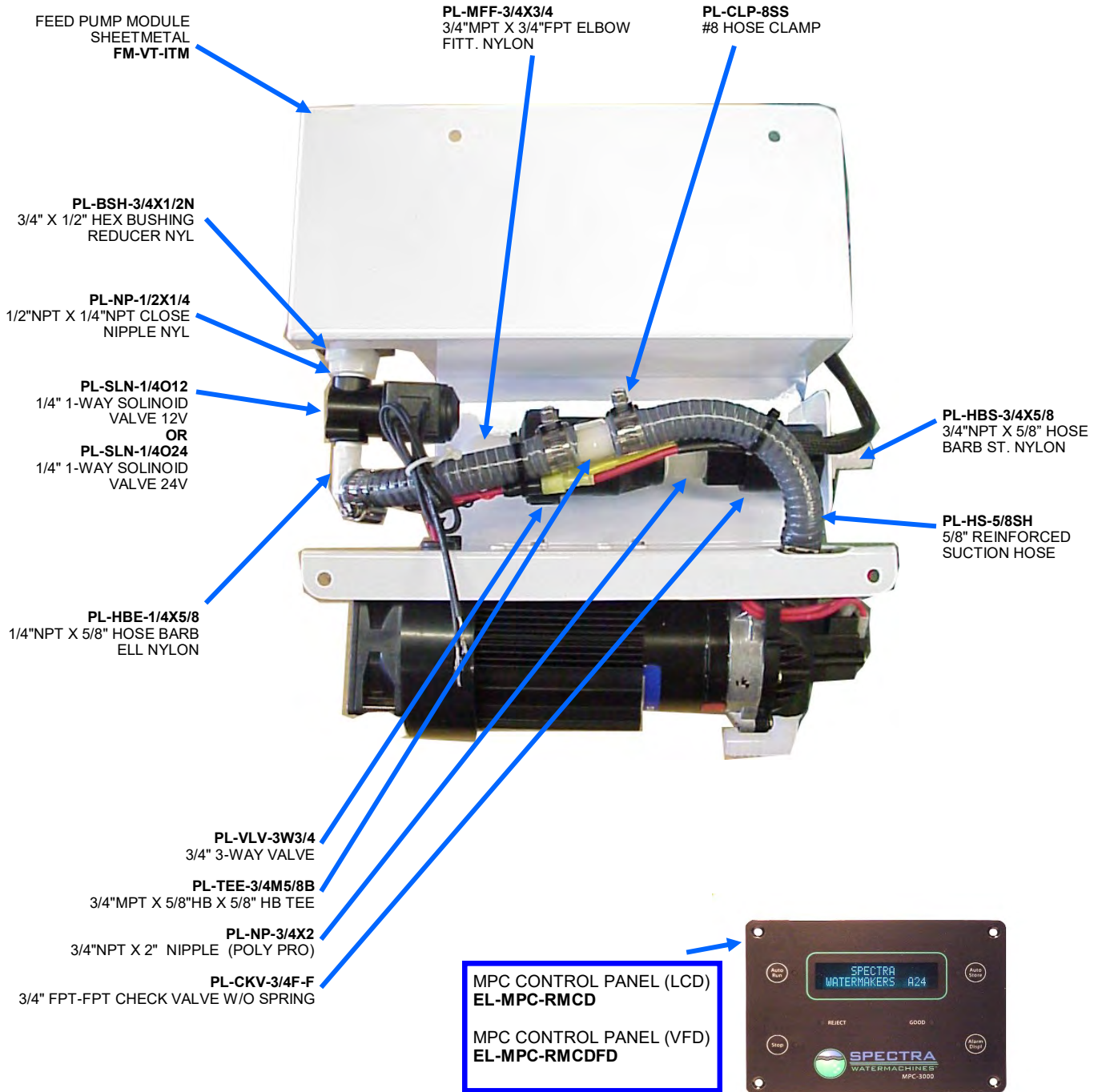

Ventura Connect & MPC

Current production
Burkert
Manifold Parts

Spartan/ECI/Alcon
Manifold Parts

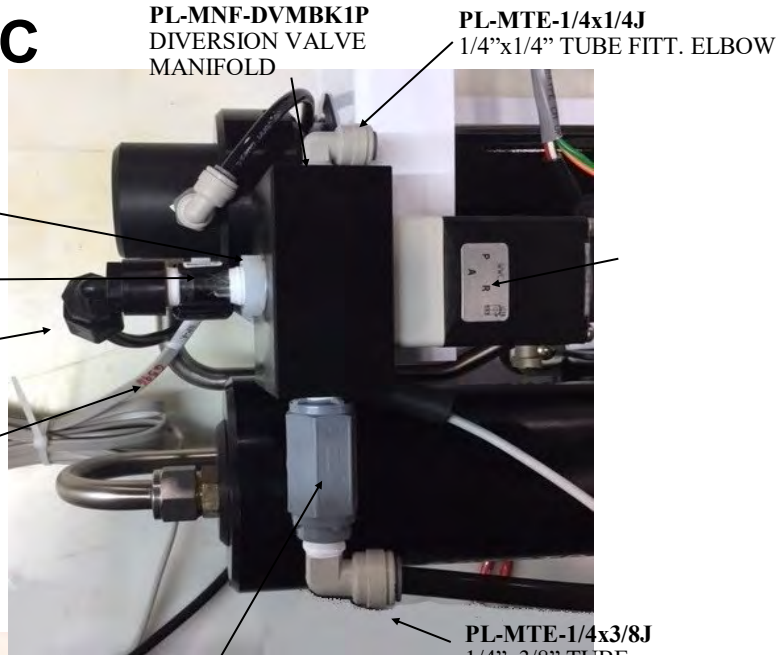

REDUCING COUPLING
PL-BSH-3/8X1/4

PL-MNF-DVMBK1P
DIVERSION VALVE
MANIFOLD

PL-MTE-1/4x1/4J
1/4"x1/4" TUBE FITT. ELBOW

EL-SSR-IFMLR
INLINE FLOW METER SENSOR

PL-FTE-1/4X1/4P
1/4"FPT X 1/4" TUBE FITT. ST.

EL-MPC-SP4
SALINITY PROBE

PL-SLN-1/4D12SP
1/4" DIVERSION VALVE 12V/24V

PL-MTE-1/4x3/8J
1/4"x3/8" TUBE
FITTING ELBOW

PL-MTE-3/8x1/4J
3/8"x1/4" TUBE FITT.
ELBOW

PL-CKV-1/4M-F
1/4" PLASTIC CK VALVE (M-F)
(with old ECI solenoids)

PL-CKV-1/4M-F
1/4" PLASTIC CK VALVE (M-F)
(with Spartan and Burkert
solenoids)

SUB-NP-DVM (or SP)
DIVERSION VALVE
MANIFOLD

PL-MTS-1/4X3/8J
1/4"NPT X 3/8" TUBE FITT.
STRAIGHT

EL-MPC-SP4
SALINITY PROBE

EL-SSR-IFMLR
INLINE FLOW METER SENSOR

PL-FTS-1/4X1/4P
1/4"FPT X 1/4" TUBE FITT. ST.

REDUCING COUPLING
PL-BSH-3/8X1/4

FM-MPC-MPCB
MPC BOX

EL-MPC-PCBDPA40
MPC-5000 CIRCUIT
BOARD

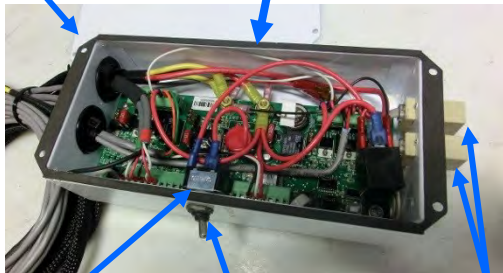

EL-SWT-TG-DPDT
TOGGLE SWITCH DP/DT

EL-TM-RJ12COUP
RJ-12 Modular
Coupler Panel

EL-SWT-TSBHC
TOGGLE SWITCH BOOT SEAL

Pressure Sensor
EL-SSR-150

1/4" Street El.
PL-MFF-1/4X1/4

Filter Housing
Bracket Duplex
FT-FHB-10HD

3/4"NPT X 5/8
Hose Barb Elbow
PL-HBE-3/4X5/8

3/4" Nipple
PL-NP-3/4N

High Pressure Filter Housing (Lid & Bowl)
FT-FTH-10H
Filter Housing O-ring
SO-FHS-10H



Bimini 300 Connect

High Pressure Module

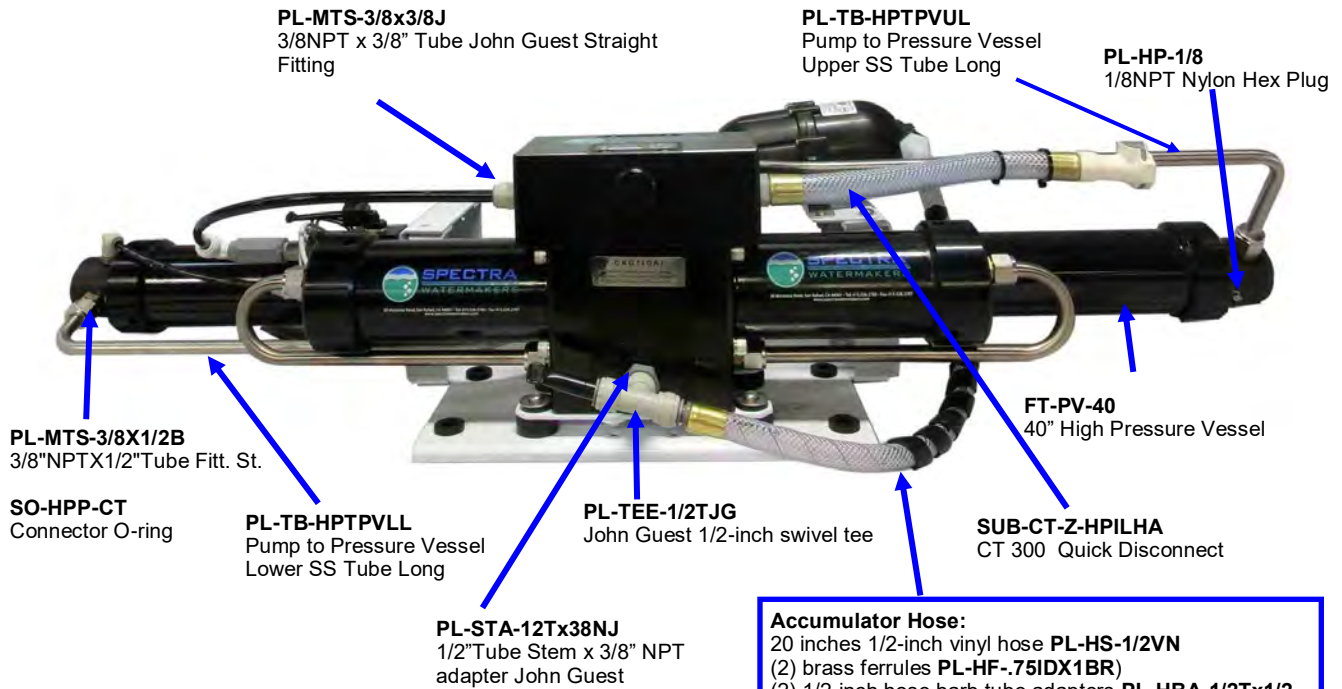

Accumulator Hose:
 20 inches 1/2-inch vinyl hose **PL-HS-1/2VN**
 (2) brass ferrules **PL-HF-.75IDx1BR**
 (2) 1/2-inch hose barb tube adapters **PL-HBA-1/2Tx1/2**
 5 inches of 3/4-inch spiral wrap **EL-LT-3/4SW**
 Hose clamps may be substituted for the brass ferrules, which are crimped on.

Accumulator

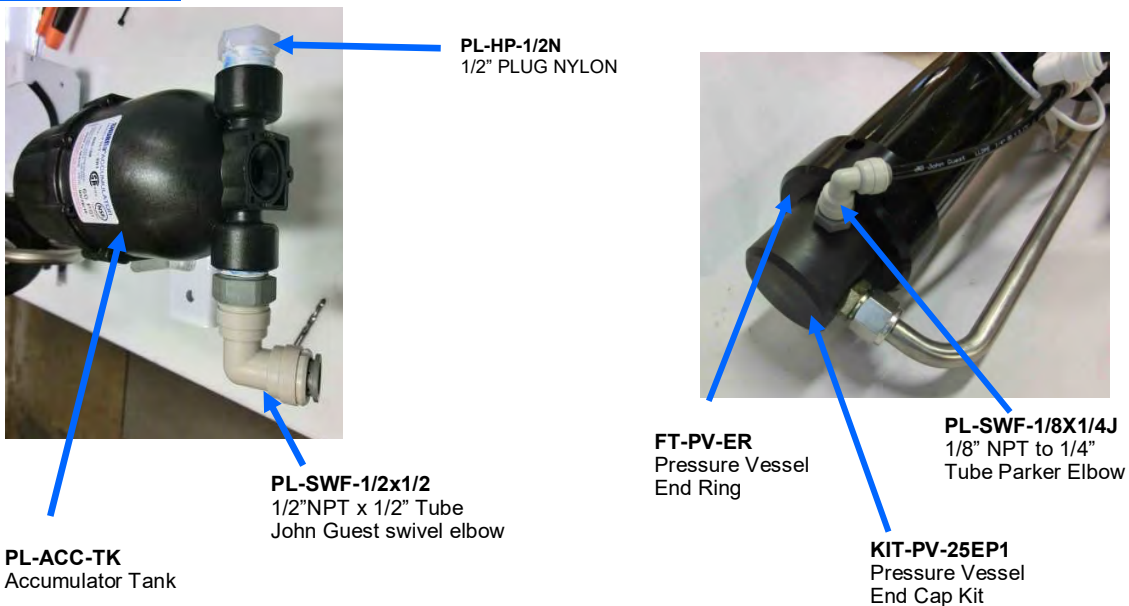

PL-ACC-TK
 Accumulator Tank

PL-SWF-1/2x1/2
 1/2"NPT x 1/2" Tube
 John Guest swivel elbow

PL-HP-1/2N
 1/2" PLUG NYLON

FT-PV-ER
 Pressure Vessel
 End Ring

KIT-PV-25EP1
 Pressure Vessel
 End Cap Kit

PL-SWF-1/8X1/4J
 1/8" NPT to 1/4"
 Tube Parker Elbow

Bimini 300 Connect

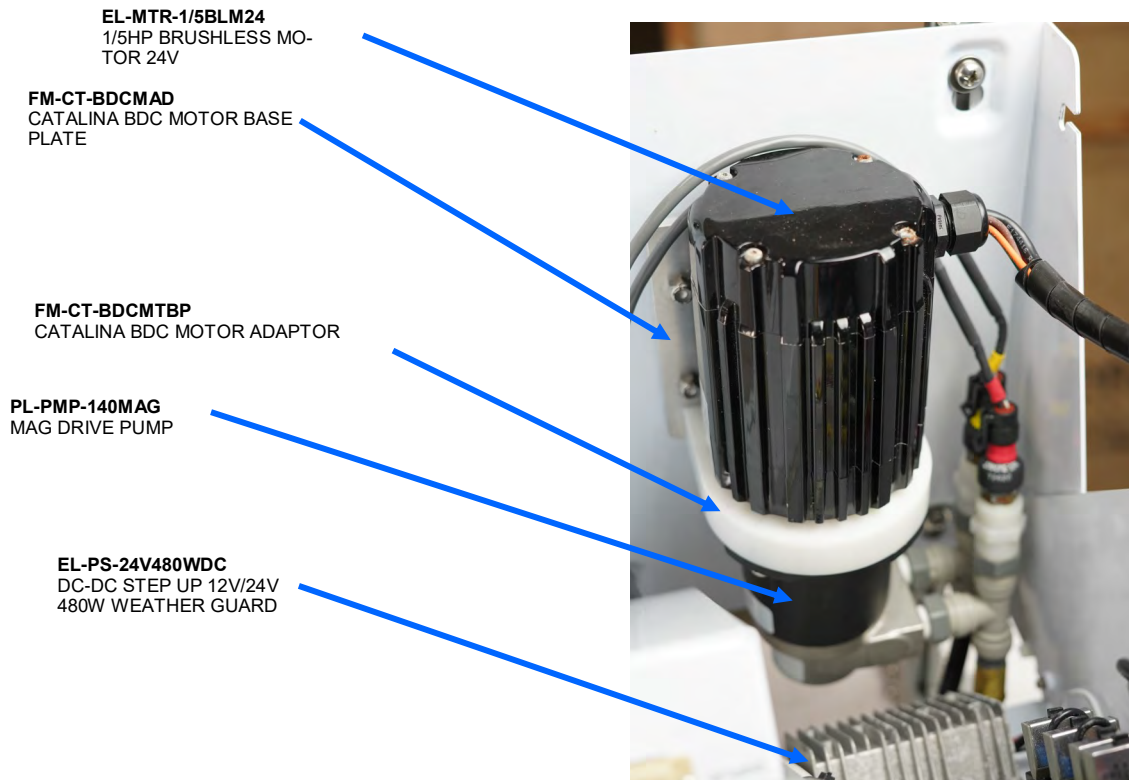
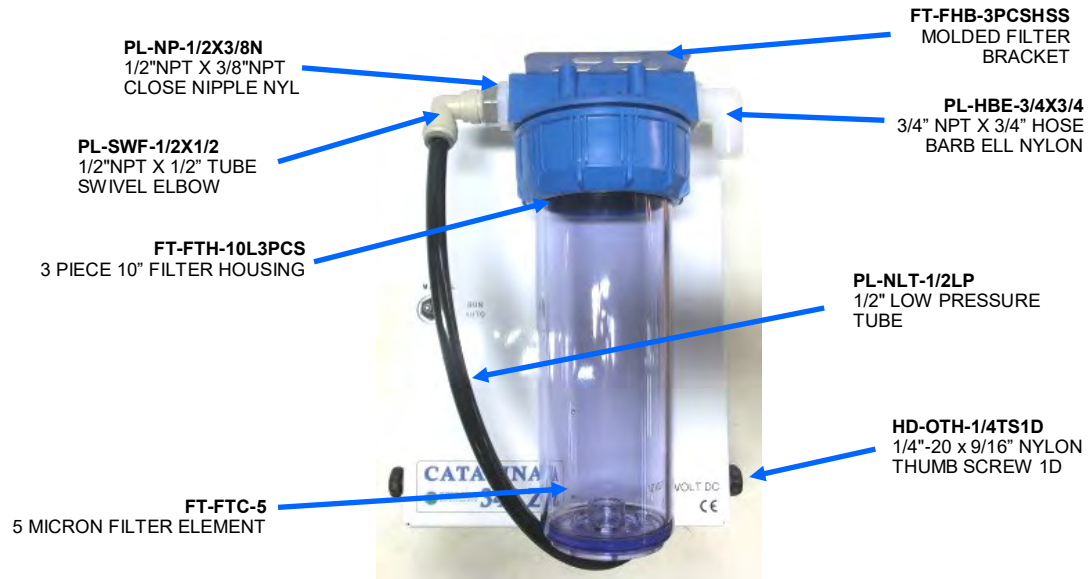

Bimini 300 Connect

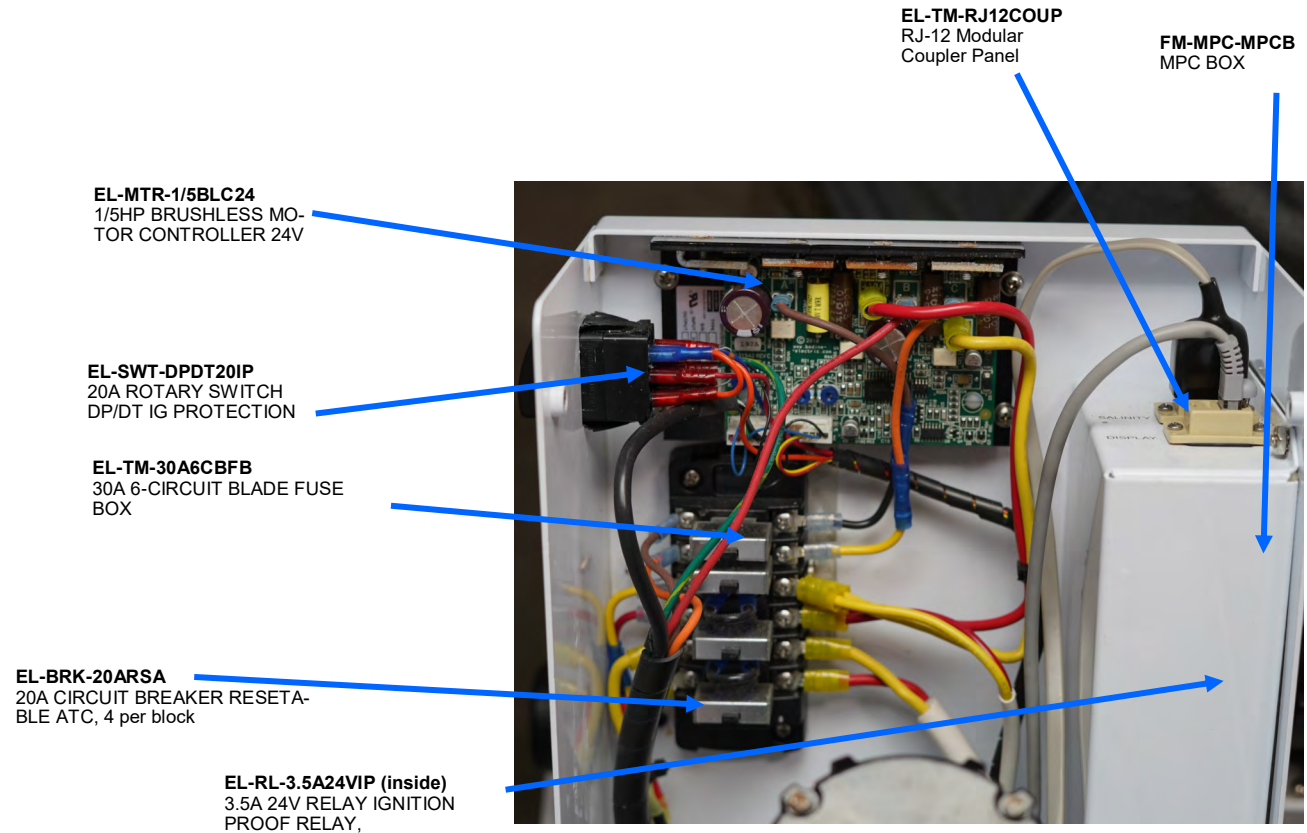
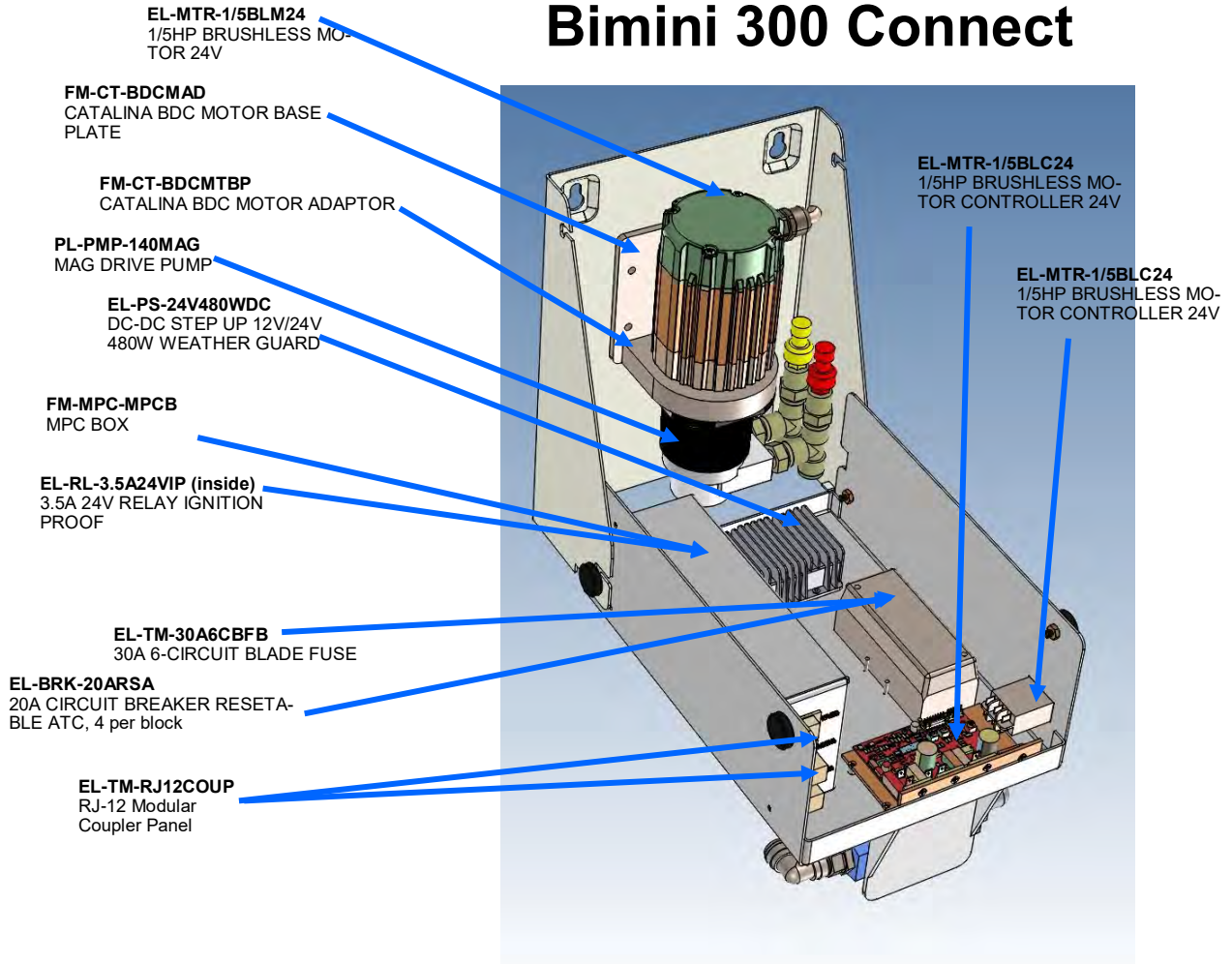

Bimini 300 Connect



EL-SSR-ABS
ABSOLUTE
PRESSUR SENSOR

EL-SSR-150
150 PSI PRESSURE SENSOR

PL-UNN-3/8x1/4N
3/8" FPT x 1/4" FPT
COUPLING NYLON

PL-TEE-1/2TJG
1/2" TUBE TEE JG

PL-STA-12TX38NJ
1/2" TUBE STEM x 3/8" NPT
ADAPTER

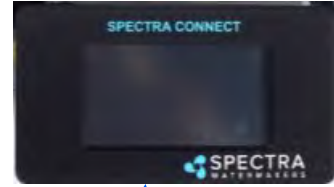

KIT-SC-RMPNL SPECTRA
CONNECT REMOTE
CNTRL.
DISP.4.3" (REMOTE, comes
with 100' of cabling)
KIT-SC-RMPNLD Display
Only

Hoses and Tubes

Inlet/Flush Hose Assembly (SUB-CT-Z-HPIBHA):

Brass ferrules for 1/2-inch hose
(**PL-HF-.75IDX1BR**)



PL-HS-1/2VN
1/2" VINYL HOSE

PL-HBA-1/2TX1/2
1/2" TUBE x 1/2" HB ADAPTER

PL-QDC-1/2HBDWV
1/2" HB QUICK DISCT. BODY
WITH VALVE

Note: Hose clamps may be substituted for brass ferrules, which require a special crimper.

PL-NLT-1/4LP
1/4" Low Pressure Tube
(Product)



PL-HS-3/4VN
3/4" VINYL HOSE



PL-HS-3/4SH
3/4" REINFORCED
SUCTION HOSE

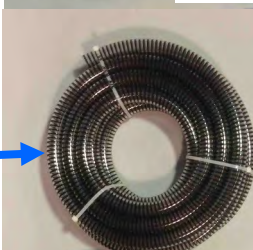

PL-HS-5/8VN
5/8" VINYL HOSE



Bimini 300 Connect

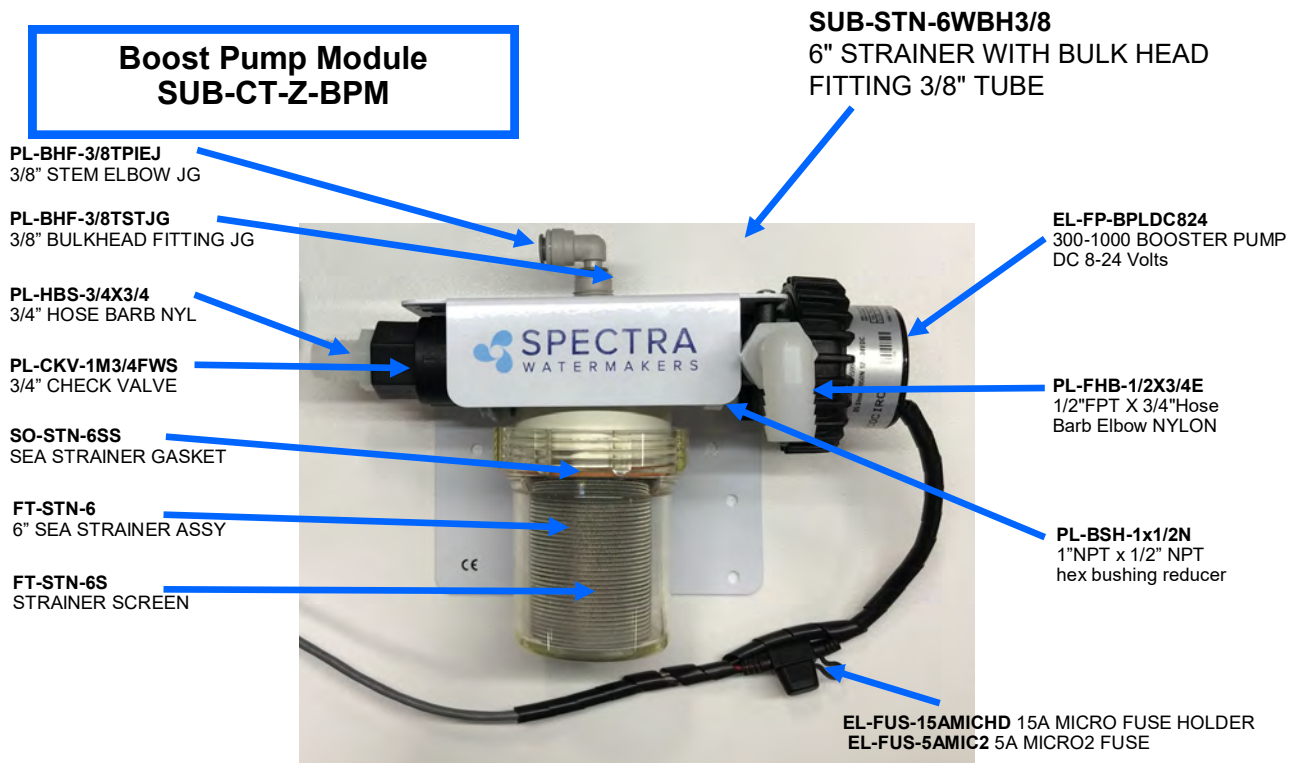

**Fresh water flush module
without Z-Ion will have the
same parts, minus modified
filter bowl and electronic box
on top.**

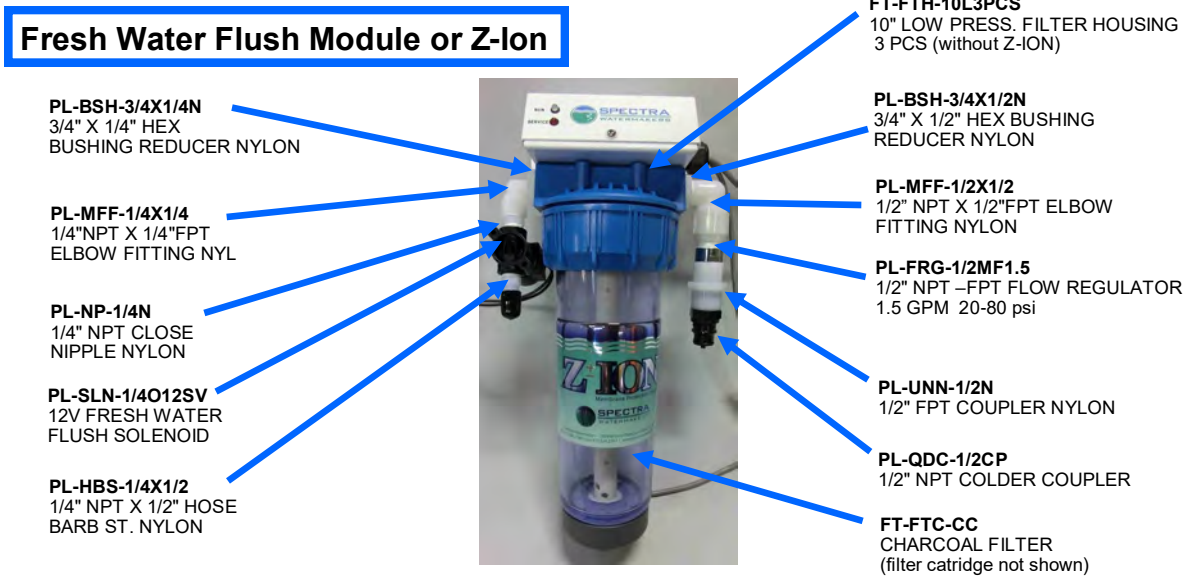

Bimini 300 Connect

Diversion Valve Manifold Assembly

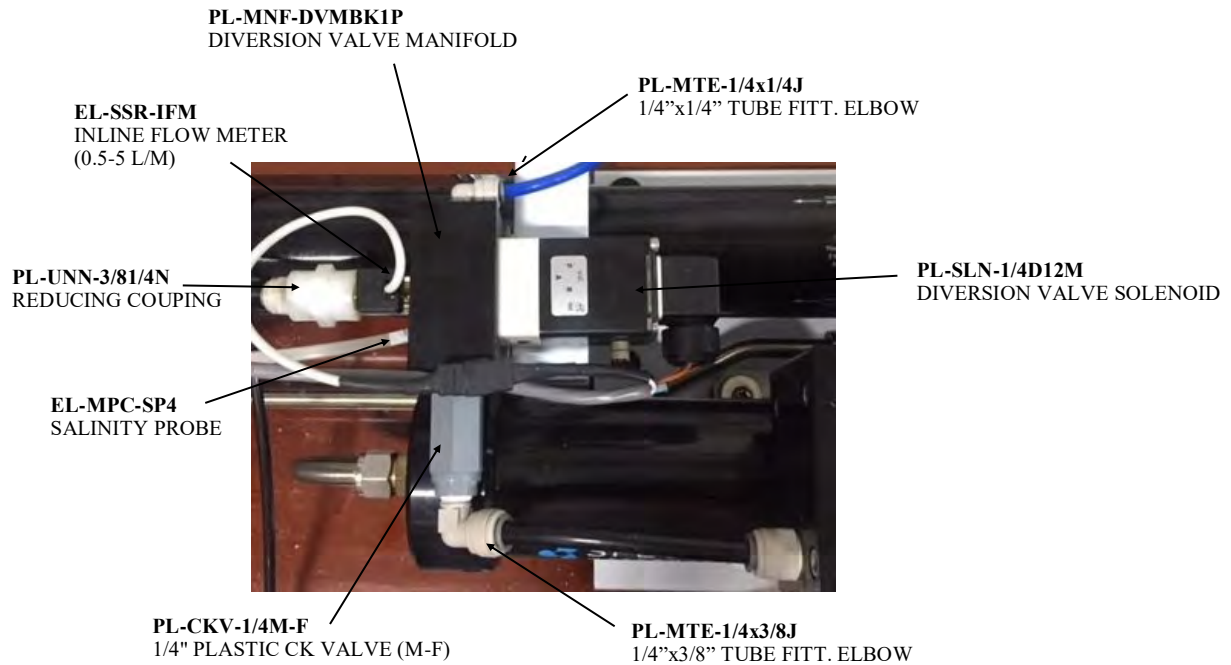

Brine Discharge Quick Connect

PL-QDC-BD3/8
3/8"NPT Quick Disc. Coupling Body

PL-QDC-HB5/8
5/8" Quick Disc. Fitting Hose Barb



SUB-MTS-3/8X1/2
Nickel-Bronze High Pressure Straight Fitting

SO-FT-STF
3/4"-16 Straight Thread O-RING

High Pressure Fittings

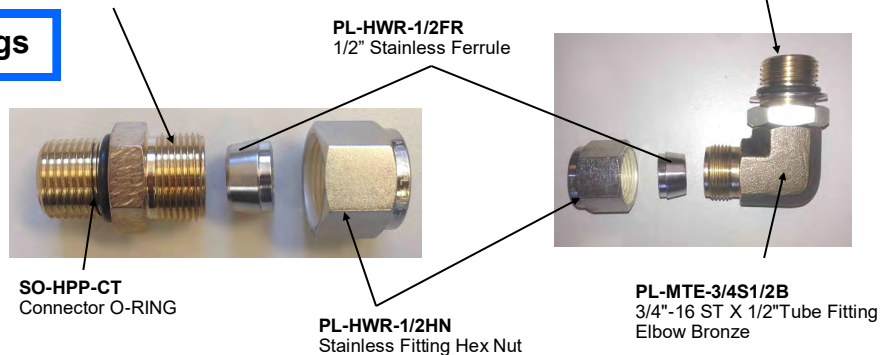

Catalina 340 Connect & Z

High Pressure Module

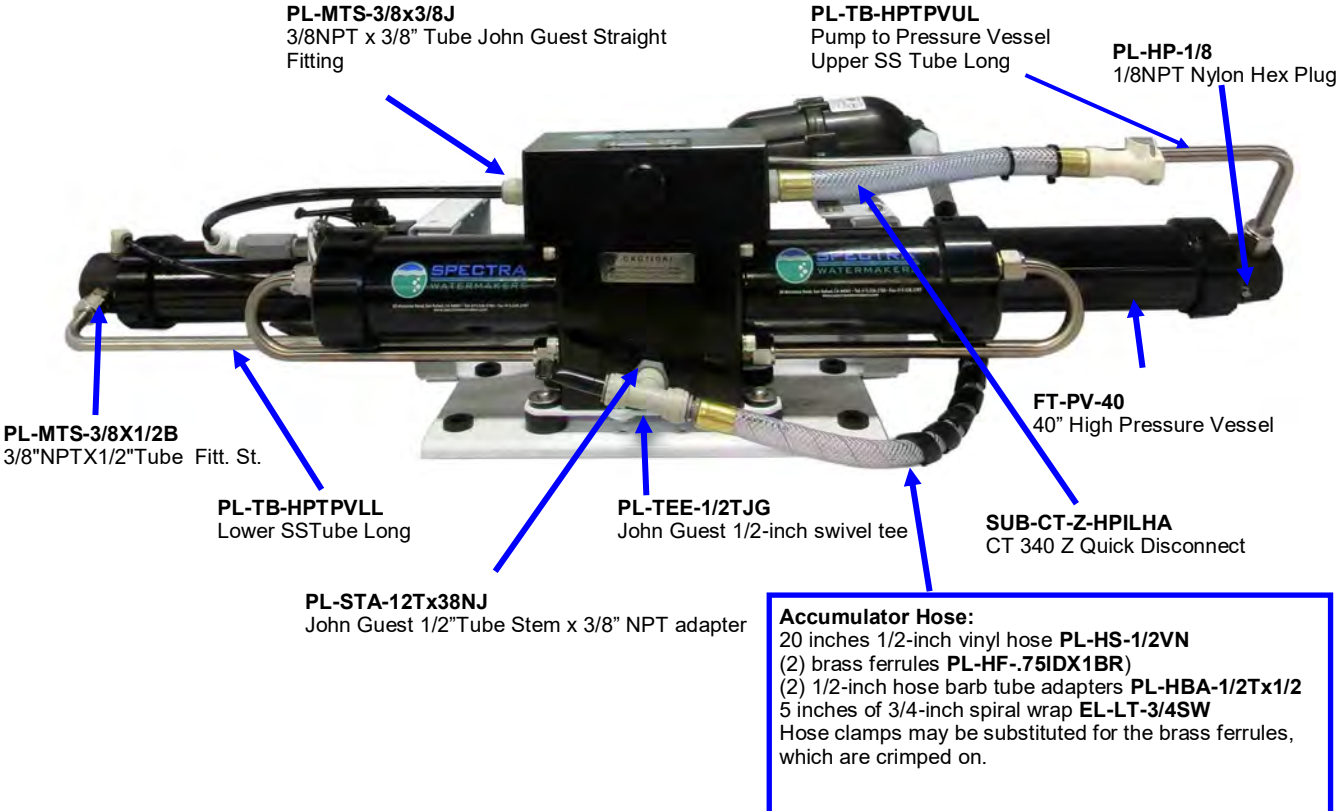

Accumulator

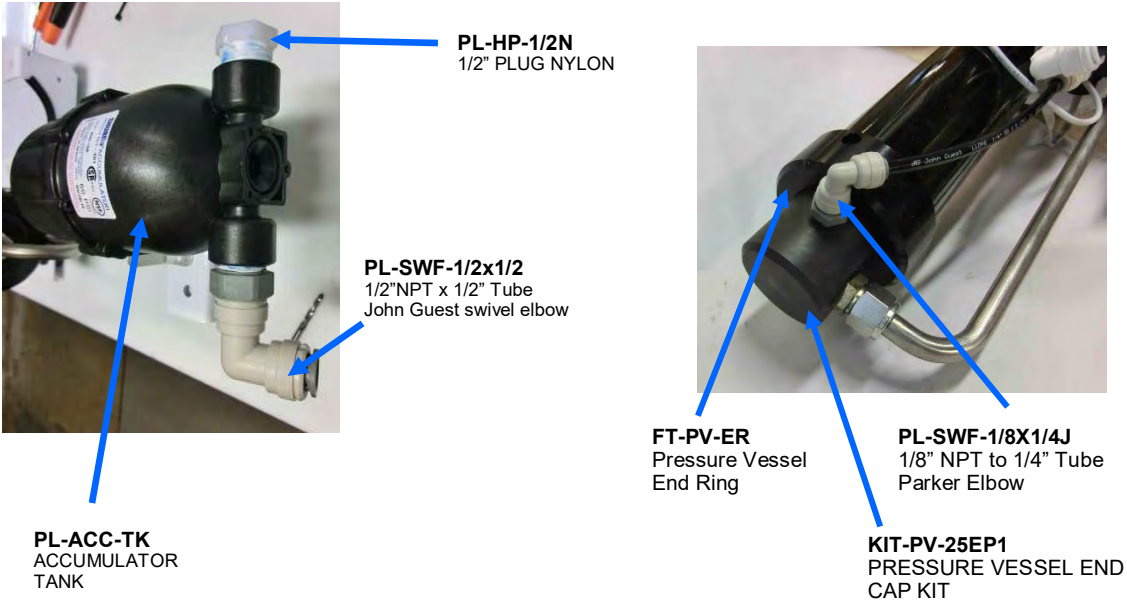

Catalina 340 Connect & Z (February 2015)

CATLINA 340 Z FEED PUMP MODULE

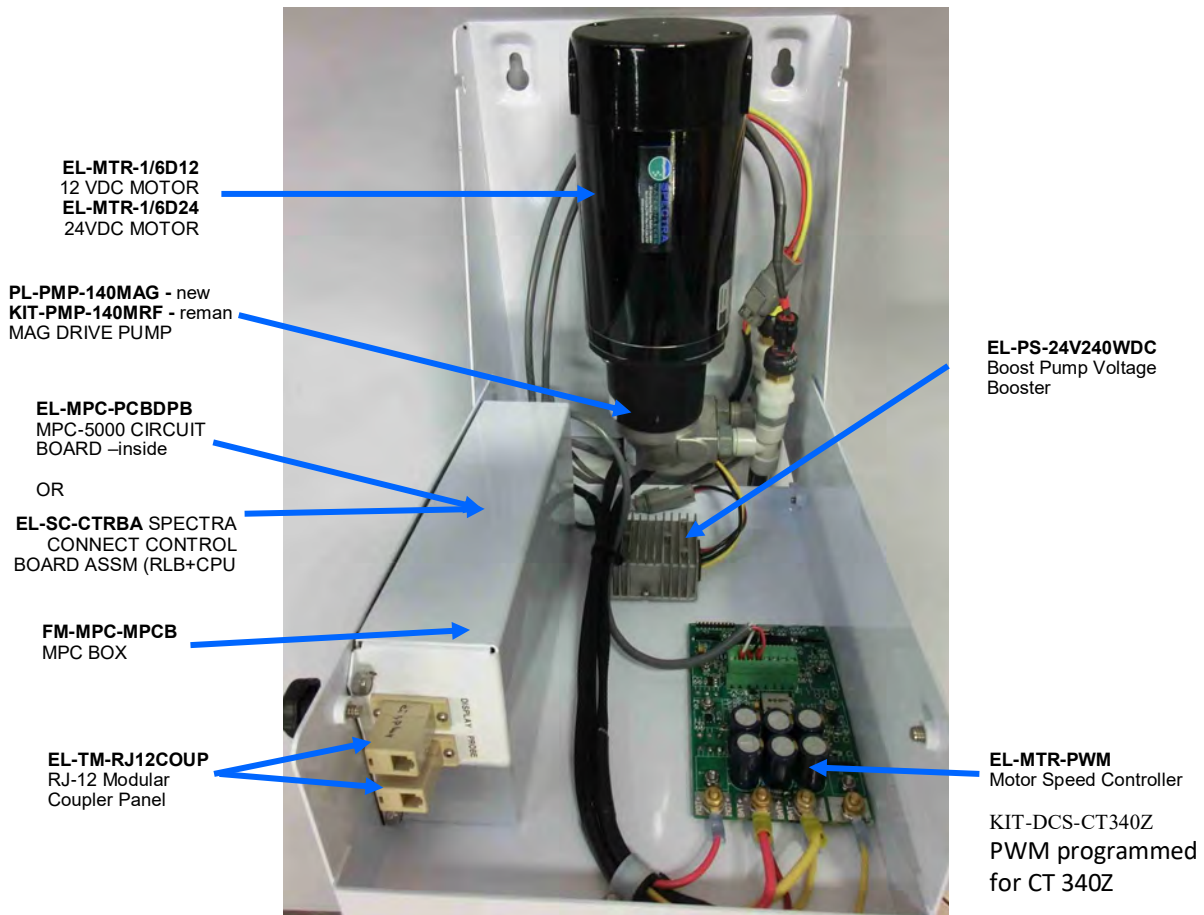
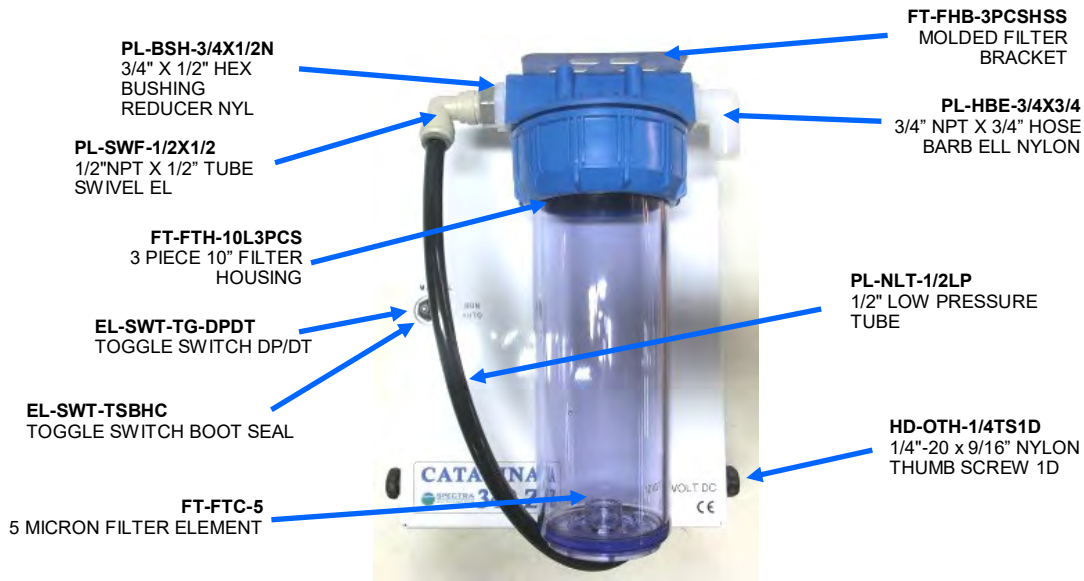

Catalina 340 Connect & Z



EL-SSR-ABS
ABSOLUTE
PRESSUR SENSOR

EL-SSR-150
150 PSI PRESSURE SEN-
SOR

PL-UNN-3/8x1/4N
3/8" FPT x 1/4" FPT
COUPLING NYLON

PL-TEE-1/2TJG
1/2" TUBE TEE JG

PL-STA-12TX38NJ
1/2" TUBE STEM x 3/8" NPT
ADAPTER



MPC CONTROL PANEL (LCD)
EL-MPC-RMCD

EL-SC-100DPC 100'
SPECTRA CON-
NECT REMOTE DIS-
PLAY CABLE

Hoses and Tubes

Inlet/Flush Hose Assembly (SUB-CT-Z-HPIBHA):

Brass ferrules for 1/2-inch hose
(**PL-HF-.75IDX1BR**)



PL-HBA-1/2TX1/2
1/2" TUBE x 1/2" HB ADAPTER

PL-HS-1/2VN
1/2" VINYL HOSE

PL-QDC-1/2HBDWV
1/2" HB QUICK DISCT. BODY
WITH VALVE



KIT-SC-RMPNL SPECTRA
CONNECT REMOTE
CNTRL.
DISP.4.3" (REMOTE, comes
with 100' of cabling)
KIT-SC-RMPNLD Display
Only

Note: Hose clamps may be substituted for brass ferrules, which require a special crimper.

PL-NLT-1/4LP
1/4" Low Pressure Tube
(Product)



PL-HS-3/4VN
3/4" VINYL HOSE



PL-HS-3/4SH
3/4" REINFORCED
SUCTION HOSE

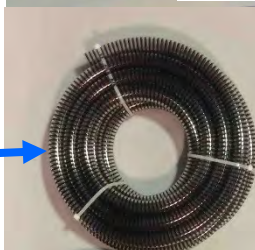

PL-HS-5/8VN
5/8" VINYL HOSE



Catalina 340 Connect & Z

Boost Pump Module SUB-CT-Z-BPM

PL-BHF-3/8TPIEJ
3/8" STEM ELBOW JG

PL-BHF-3/8TSTJG
3/8" BULKHEAD FITTING JG

PL-HBS-3/4X3/4
3/4" HOSE BARB NYL

PL-CKV-1M3/4FWS
3/4" CHECK VALVE

SO-STN-6SS
SEA STRAINER GASKET

FT-STN-6
6" SEA STRAINER ASSY

FT-STN-6S
STRAINER SCREEN

SUB-STN-6WBH3/8
6" STRAINER WITH BULK HEAD
FITTING 3/8" TUBE

EL-FP-BPLDC824
300-1000 BOOSTER PUMP
DC 8-24 Volts

PL-FHB-1/2X3/4E
1/2"FPT X 3/4"Hose
Barb Elbow NYLON

PL-BSH-1x1/2N
1"NPT x 1/2" NPT
hex bushing reducer

EL-FUS-15AMICHD 15A MICRO FUSE HOLDER
EL-FUS-5AMIC2 5A MICRO2 FUSE

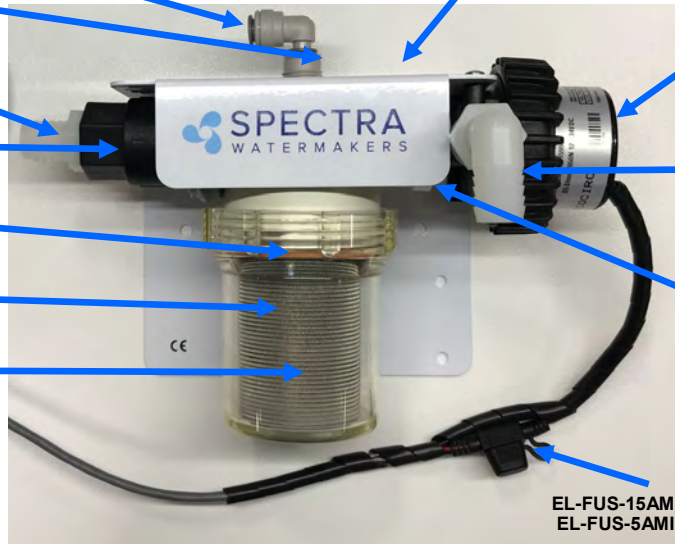

Fresh water flush module
without Z-Ion will have the
same parts, minus modified
filter bowl and electronic box
on top.

Fresh Water Flush Module or Z-Ion

PL-BSH-3/4X1/4N
3/4" X 1/4" HEX
BUSHING REDUCER NYLON

PL-MFF-1/4X1/4
1/4"NPT X 1/4"FPT
ELBOW FITTING NYL

PL-NP-1/4N
1/4" NPT CLOSE
NIPPLE NYLON

PL-SLN-1/4O12SV
12V FRESH WATER
FLUSH SOLENOID

PL-HBS-1/4X1/2
1/4" NPT X 1/2" HOSE
BARB ST. NYLON

FT-FTH-10L3PCS
10" LOW PRESS. FILTER
HOUSING 3 PCS
(without Z-ION)

PL-BSH-3/4x1/2N
3/4" X 1/2" HEX BUSHING
REDUCER NYLON

PL-MFF-1/2X1/2
1/2" NPT X 1/2"FPT ELBOW
FITTING NYLON

PL-FRG-1/2MF1.5
1/2" NPT-FPT FLOW REG.
1.5G 20-80P

PL-UNN-1/2N
1/2" FPT COUPLER NYLON

PL-QDC-1/2CP
1/2" NPT COLDER COUPLER

FT-FTC-CC
CHARCOAL FILTER
(inside housing, not shown)



Catalina 340 Connect & Z

Diversion Valve Manifold Assembly

Current production

Burkert
Manifold Parts

Spartan/ECI/Alcon
Manifold Parts

PL-MNF-DVMBK1P
DIVERSION VALVE MANIFOLD

PL-MTE-1/4x1/4J
1/4"x1/4" TUBE FITT. ELBOW

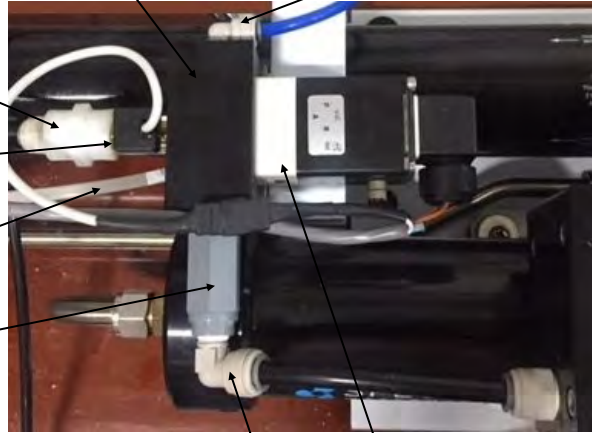

PL-UNN-3/81/4N
REDUCING COUPLING

EL-SSR-IFM
INLINE FLOW METER
(0.5-5 L/M)

EL-MPC-SP4
SALINITY PROBE

PL-CKV-1/4M-F
1/4" PLASTIC CK VALVE (M-F)

PL-SLN-1/4D12M
DIVERSION VALVE SOLENOID

PL-MTE-3/8x1/4J
3/8"x1/4" TUBE FITT. EL JG

PL-SLN-1/4D12SP
1/4" DIVERSION VALVE 12V SPART

PL-MTE-1/4x3/8J
1/4"x3/8" TUBE FITT. ELBOW

SUB-NP-DWMSP
DIVERSION VALVE
MANIFOLD

PL-MTE-1/4X3/8J
1/4"NPT X 3/8" TUBE EL JG

PL-CKV-18Nx14FP
1/8"NPT x1/4"FPT Check Valve

EL-MPC-SP4
SALINITY PROBE

EL-SSR-IFM
INLINE FLOW METER SENSOR

PL-MTS-1/4x1/4J
1/4"NPT x 1/4" Tube John Guest straight fitting

PL-UNN-3/81/4N
REDUCING COUPLING

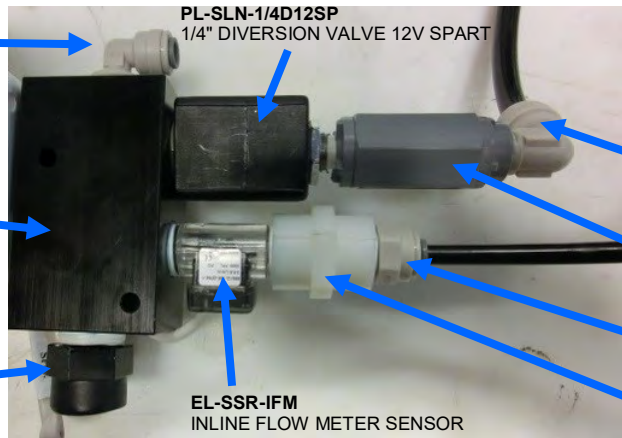

Brine Discharge Quick Connect

PL-QDC-BD3/8
3/8"NPT Quick Disc. Coupling Body

PL-QDC-HB5/8
5/8" Quick Disc. Fitting Hose Barb



High Pressure Fittings

SUB-MTS-3/8X1/2
Nickel-Bronze High Pressure Straight Fitting

PL-HWR-1/2FR
1/2" Stainless Ferrule

SO-FT-STF
3/4"-16 Straight Thread O-RING

Complete Assembly
PL-MTS-3/8X1/2B

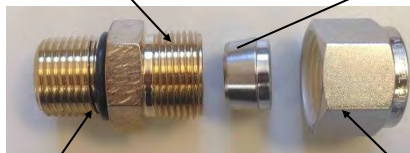

SO-HPP-CT
Connector O-RING

PL-HWR-1/2HN
1/2" Stainless Hex Nut

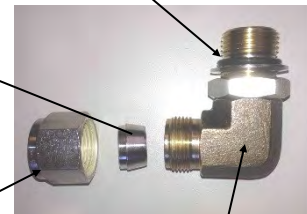

PL-MTE-3/4S1/2B
3/4"-16 ST X 1/2" TUBE FITT.
ELBOW BRONZE

Newport Series Intake Manifold

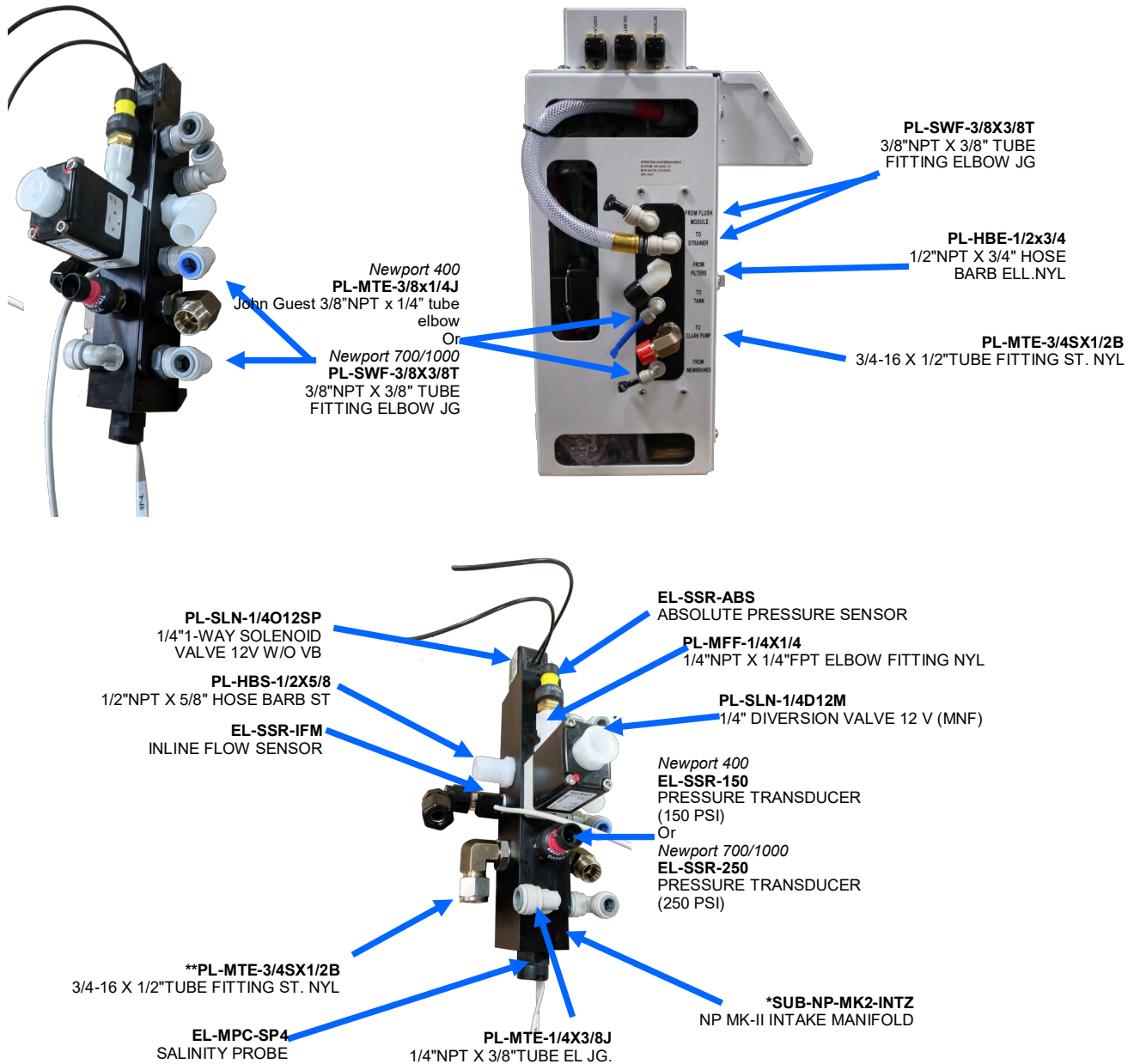

***NP MK-II INTAKE MANIFOLD:** Machined black manifold. Two previous models were made; the original manifold only had five fittings on the outside, use part number **SUB-NP-MK2-INT**. After this was the six fitting version which fits ECI or Alcon Solenoid, for this use part number **SUB-NP-MK2-INEZ**.

****3/4-16 X 1/2" TUBE FITTING ST. NYL:** High pressure compression fitting. Comes with (sealing) O-ring, nut, and ferrule.

Newport 400 C & MkII-Z (October 2014)

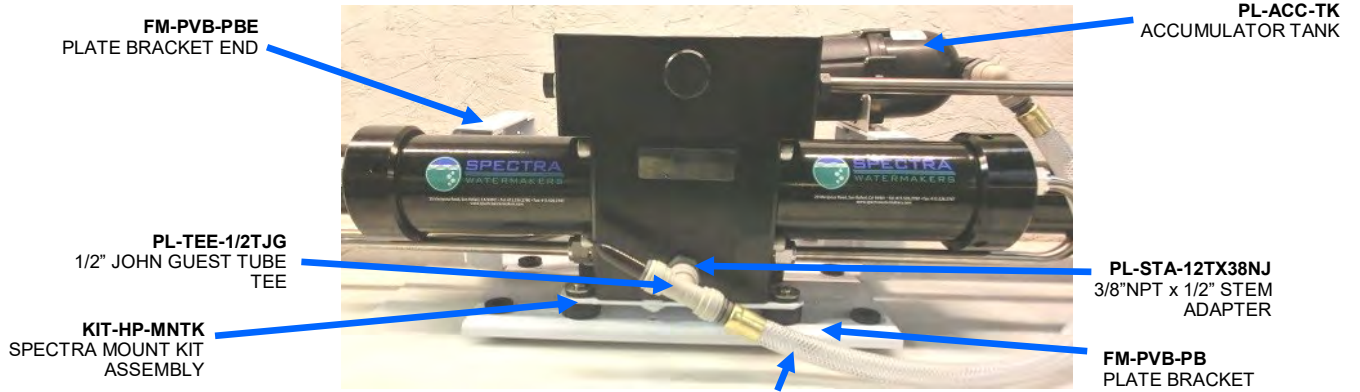

Accumulator Hose:
20 inches 1/2-inch vinyl hose **PL-HS-1/2VN**
(2) brass ferrules **PL-HF-.75IDX1BR**
(2) 1/2-inch hose barb tube adapters **PL-HBA-1/2Tx1/2**
5 inches of 3/4-inch spiral wrap **EL-LT-3/4SW**
Hose clamps may be substituted for the brass ferrules, which are crimped on.

PL-TB-HPTPVUL
Pump to Pressure Vessel Upper
SS Tube

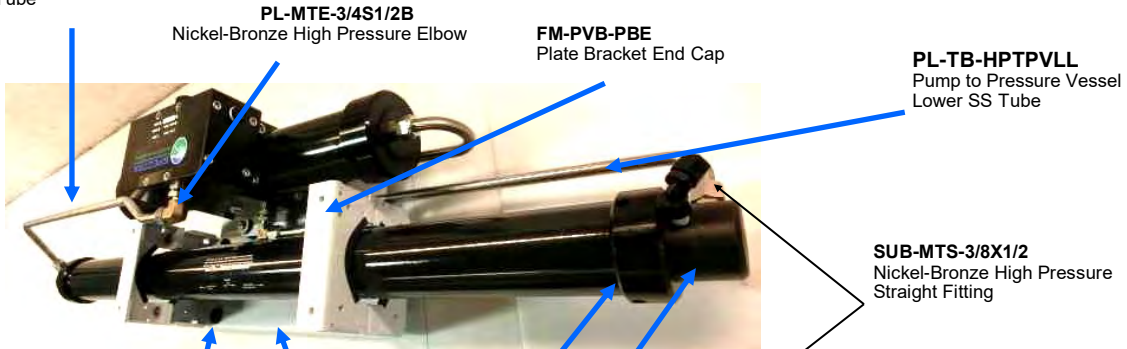

Complete Assembly
PL-MTS-3/8X1/2B

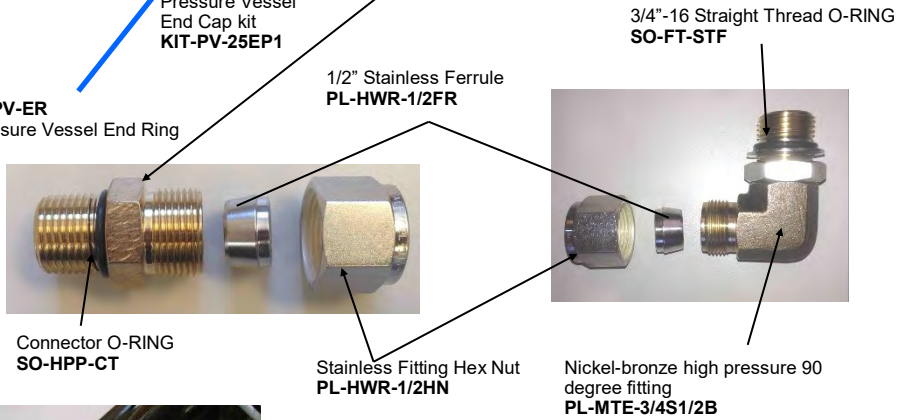

PL-SWF-1/8x1/4J
1/8" NPT to 1/4" Tube
Parker Ell

FT-PV-ER
Pressure Vessel End
Ring

KIT-PV-25EP1
PRESSURE VESSEL
END CAP kit



Newport 400 Connect & MkII-Z

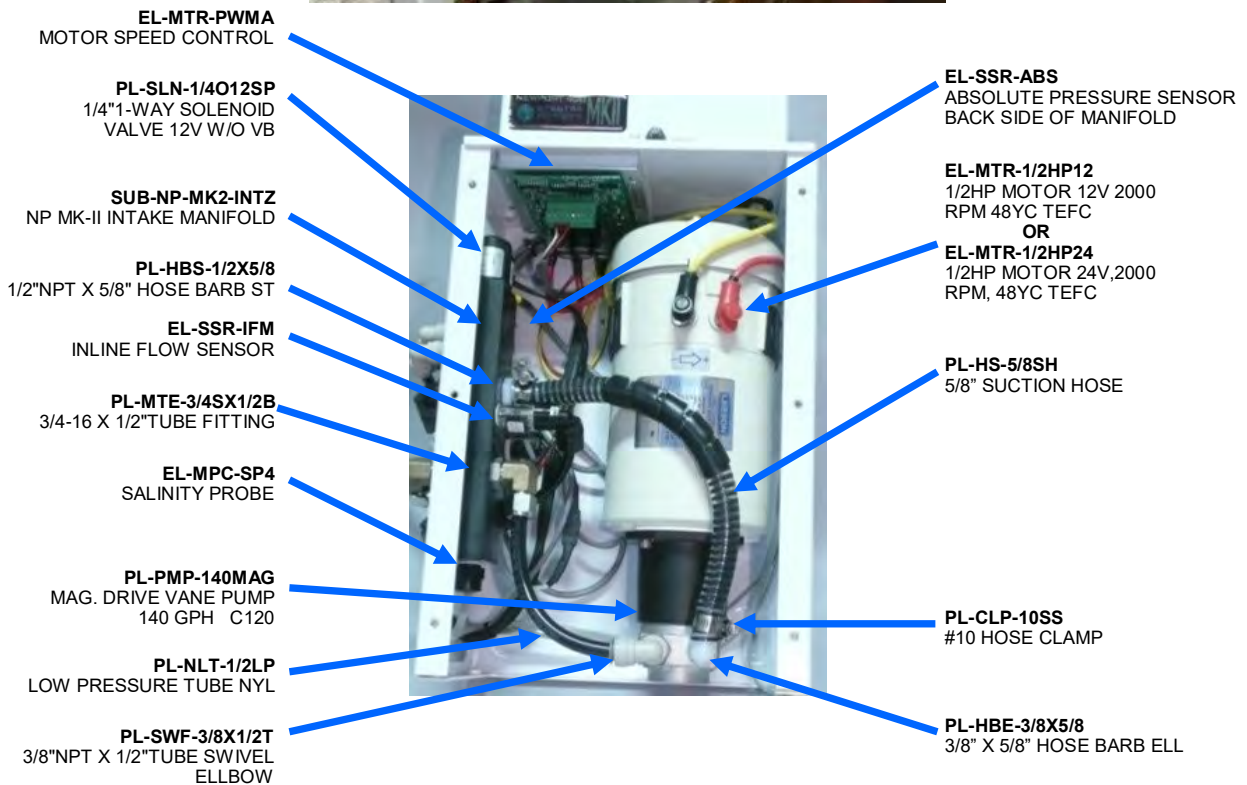
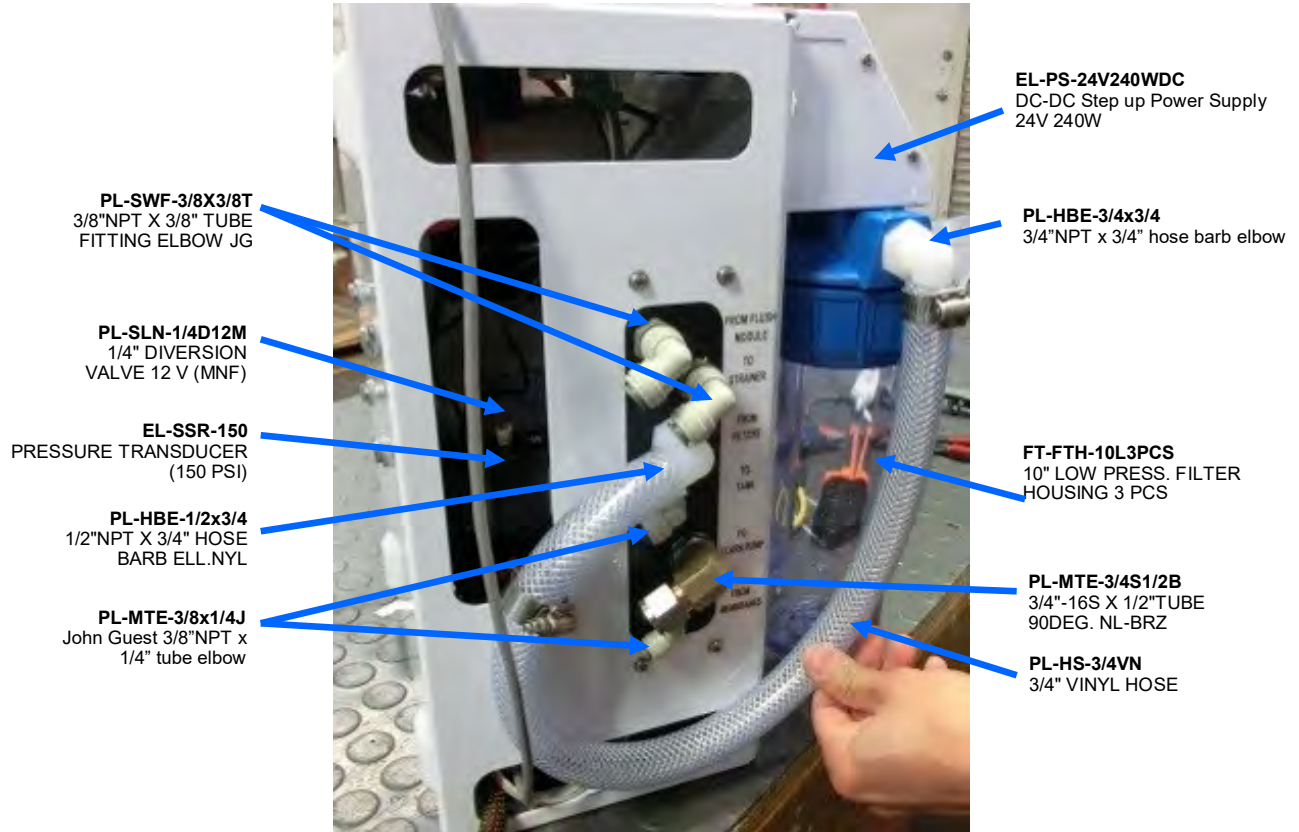

Newport 400 Connect & MkII-Z

PL-BHF-3/8TPIEJ
3/8" STEM ELBOW JG

PL-BHF-3/8TSTJG
3/8" BULKHEAD FITTING JG

PL-HBS-3/4X3/4
3/4" HOSE BARB NYL

PL-CKV-1M3/4FWS
3/4" CHECK VALVE

SO-STN-6SS
SEA STRAINER GASKET

FT-STN-6
6" SEA STRAINER ASSY

FT-STN-6S
STRAINER SCREEN

SUB-STN-6WBH3/8
6" STRAINER WITH BULK HEAD
FITTING 3/8" TUBE

EL-FP-BPLDC824
300-1000 BOOSTER PUMP
DC 8-24 Volts

PL-FHB-1/2X3/4E
1/2"FPT X 3/4"Hose
Barb Elbow NYLON

PL-BSH-1x1/2N
1"NPT x 1/2" NPT
hex bushing reducer

Boost Pump Module SUB-CT-Z-BPM

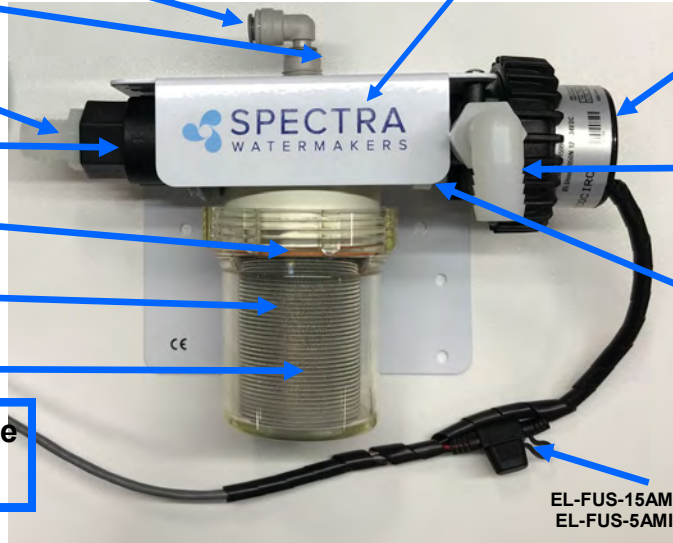

EL-FUS-15AMICHD 15A MICRO FUSE HOLDER
EL-FUS-5AMIC2 5A MICRO2 FUSE

Accumulator



PL-HP-1/2N
1/2" PLUG NYLON

PL-ACC-TK
ACCUMULATOR
TANK

PL-SWF-1/2x1/2
1/2"NPT x 1/2" Tube
John Guest swivel elbow

Brine Discharge Quick Connect

PL-QDC-BD3/8
3/8"NPT Quick Disc.
Coupling Body

PL-QDC-HB5/8
5/8" Quick Disc.
Fitting Hose Barb

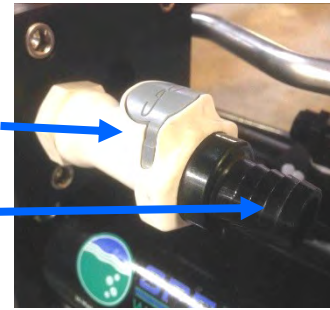

Fresh Water Flush Module or Z-Ion

Fresh water flush module
without Z-Ion will have the
same parts, minus modified
filter bowl and electronic box
on top.

PL-BSH-3/4X1/4N
3/4" X 1/4" HEX
BUSHING REDUCER NYLON

PL-VLV-1/4FMELP
1/4" F-M PVC VALVE
ELBOW

PL-HBS-1/4X1/2
1/4" NPT X 1/2" HOSE
BARB ST. NYLON

FT-FTH-10L3PCS
10" LOW PRESS. FILTER
HOUSING 3 PCS (without Z-
ION)

PL-MFF-3/4X3/4
3/4" NPT X 3/4"FPT ELBOW
FITTING NYLON

PL-NP-3/4X1/2N
3/4" NPTx1/2"NPT CLOSE
NIPPLE NYLON

PL-FRG-1/2MF1.5
1/2" NPT-FPT FLOW REG.
1.5G 20-80P

PL-FTS-1/2X3/8P
1/2" FPT x 3/8" TUBE
STRAIGHT

FT-FTC-CC
CHARCOAL FILTER
(inside housing, not shown)



Newport 400 Connect & MkII-Z

MPC 5000 Control Box

EL-SWT-TSBHC
TOGGLE SWITCH BOOT
SEAL

FM-MPC-MPCB
MPC BOX

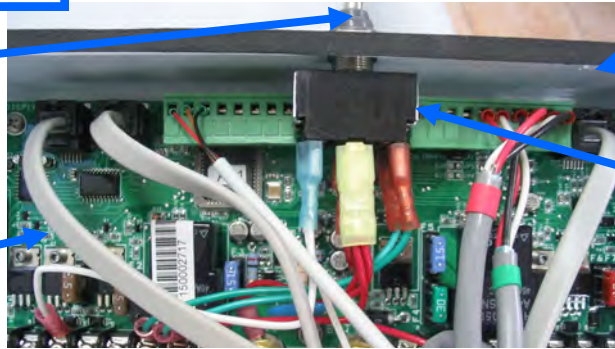

EL-SWT-TG-DPDT
TOGGLE SWITCH DP/
DT

EL-MPC-PCBDPB
MPC-5000 CIRCUIT
BOARD

EL-SC-CTRBA SPECTRA
CONNECT CONTROL
BOARD ASSM (RLB+CPU)

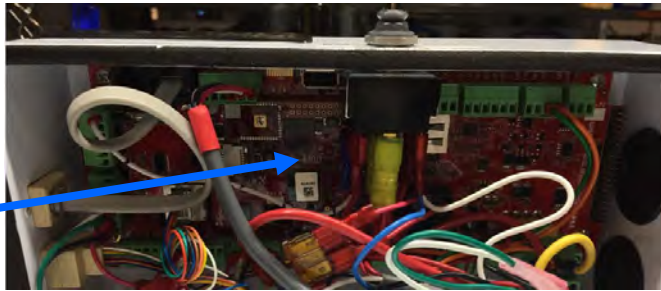

Hoses and Tubes

Feed pump to strainer hose assembly (**SUB-NP-M2Z-FPSL**):

Brass ferrules for 1/2-inch hose
(**PL-HF-.75IDX1BR**)



#6 Hose Clamp
(**PL-CLP-6SS**)

1/2" Vinyl Hose
(**PL-HS-1/2VN**)

1/2" HB Quick Disconnect Body
with Valve
(**PL-QDC-1/2HBDWV**)

3/8" T Stem x 1/2 HB Adapter
(**PL-HBA-3/8TX1/2**)

NEWPORT MK-II Z HP INLET HOSE (**KIT-NP-M2Z-HPIH**):

1/2-inch vinyl hose
(**PL-HS-1/2VN**)



Stainless Fitting Hex
Nut
(**PL-HWR-1/2HN**)

1/2" John Guest stem fitting to
1/2" hose barb adapter
(**PL-HBA-1/2TX1/2**)

1/2" Stainless Ferrule
(**PL-HWR-1/2FR**)

Brass ferrules for 1/2-inch hose
(**PL-HF-.75IDX1BR**)

Note: Hose clamps may be substituted for brass ferrules, which require a special crimper.

Newport 400 Connect & MkII-Z

Hoses and Tubes cont.

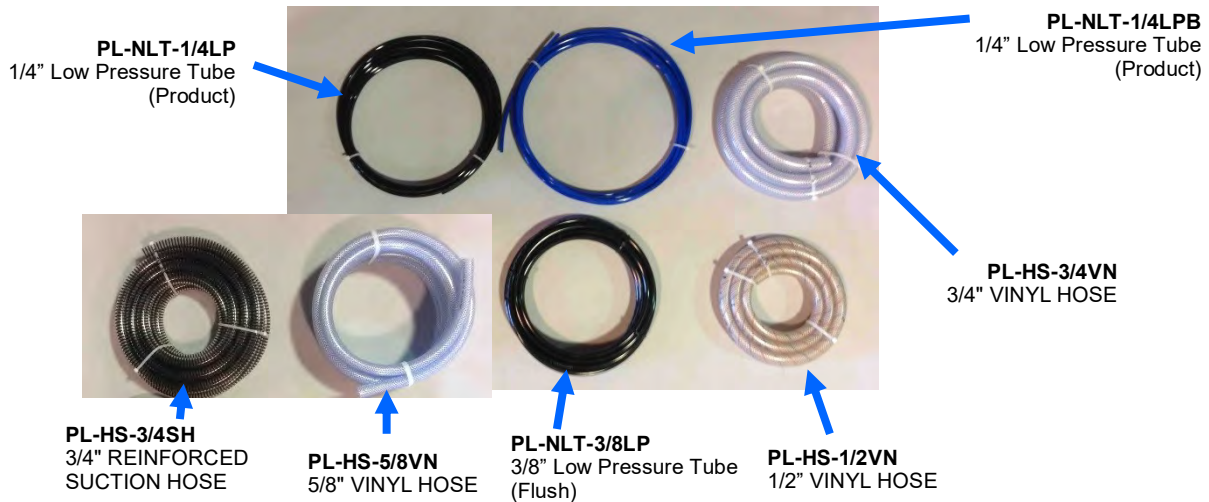

Quick Disconnect Pigtail (installed at "to strainer" fitting on feed pump module):

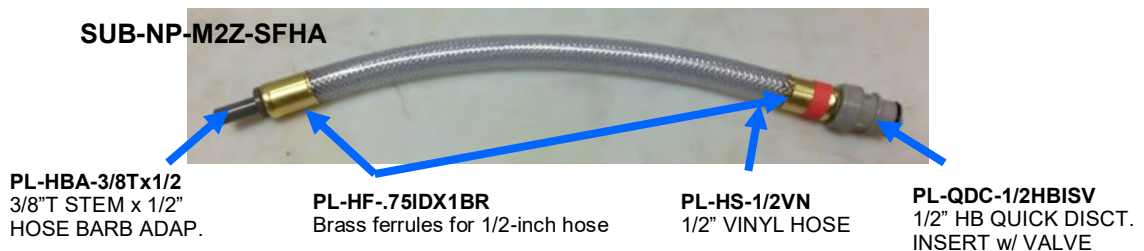

Note: Hose clamps may be substituted for brass ferrules, which require a special crimper.

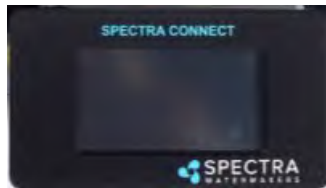

KIT-SC-RMPNL SPECTRA CONNECT REMOTE CNTRL.
DISP.4.3" (REMOTE, comes with 100' of cabling)
KIT-SC-RMPNLD Display Only

Newport 700/1000C & MkII-Z (October 2014)

Newport 1000 MkII Z High Pressure Module

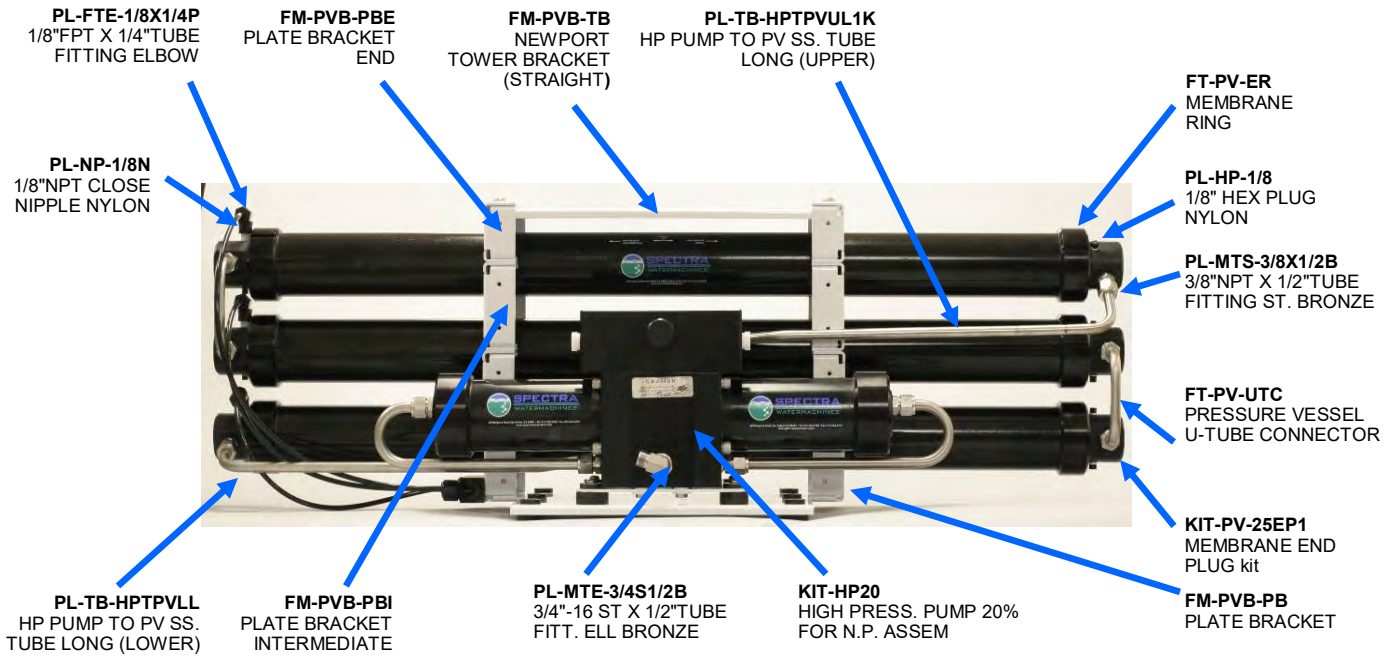

Newport 700 MkII Z High Pressure Module

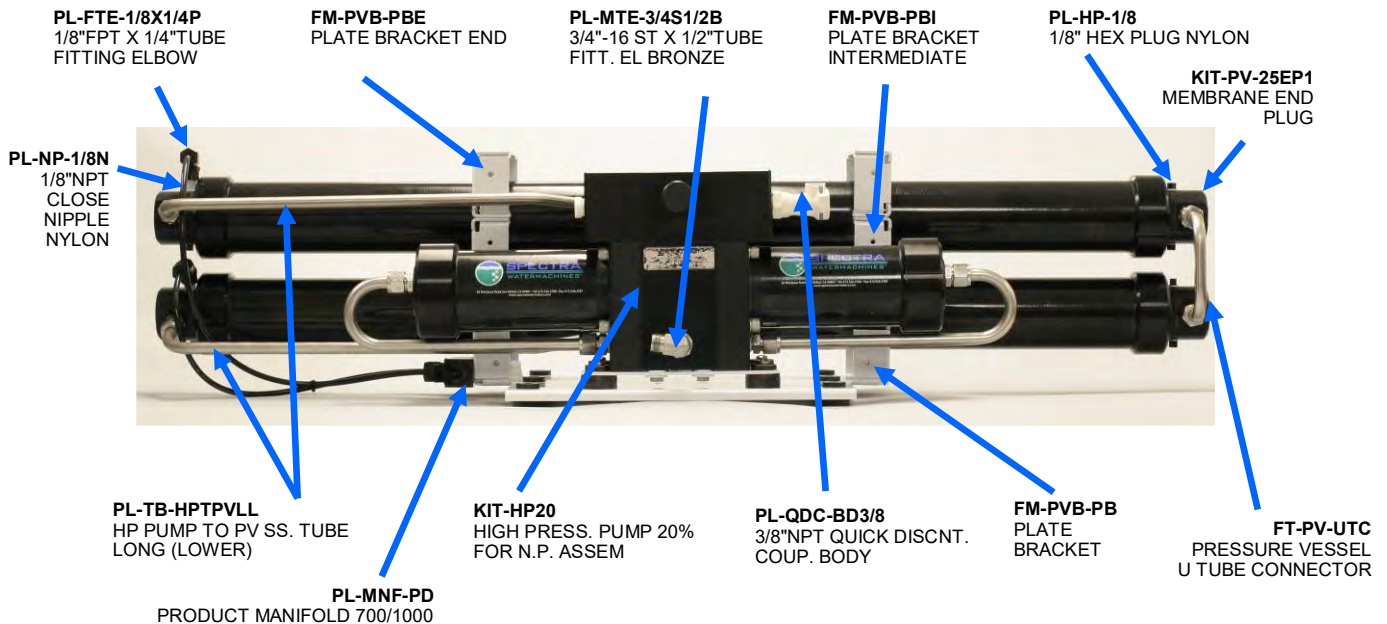

Newport 700/1000 MkII-Z

Product Water Manifold

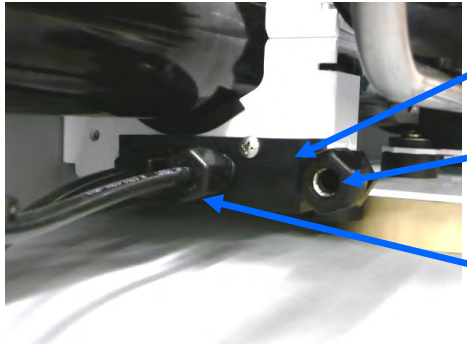

PL-MNF-PD
PRODUCT MANIFOLD
700/1000

PL-MTE-3/8X3/8J
3/8"NPT X 3/8" TUBE
FITTING ELBOW JG

PL-MTS-1/4X1/4J
1/4"NPT X 1/4" TUBE
FITTING ST. JG

Brine Discharge Quick Connect

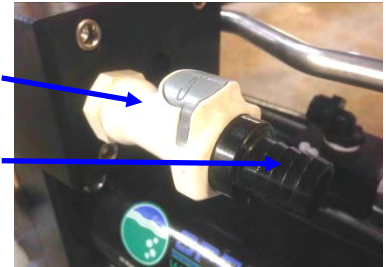

PL-QDC-BD3/8
3/8"NPT Quick Disc.
Coupling Body

PL-QDC-HB5/8
5/8" Quick Disc.
Fitting Hose Barb

High Pressure Fittings

SUB-MTS-3/8X1/2
Nickel-Bronze High Pressure Straight
Fitting

PL-HWR-1/2FR
1/2" Stainless Ferrule

SO-FT-STF
3/4"-16 Straight Thread O-RING

Complete Assembly
PL-MTS-3/8X1/2B

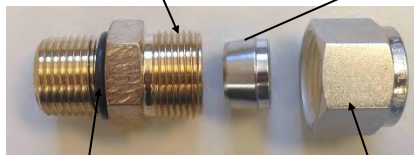

Connector O-RING
SO-HPP-CT

Stainless Fitting Hex Nut
PL-HWR-1/2HN

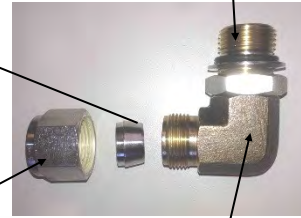

PL-MTE-3/4S1/2B
3/4"-16 ST X 1/2" Tube
Fitt. Elbow Bronze

Sea Strainer & Boost Pump Module

FM-ZION-SBPBRK
Z-ION STRAINER BOOST
PUMP BRACKET

PL-BHF-3/8TPIEJ
3/8" TUBE PLUG-IN ELBOW

PL-BHF-3/8TSTJG
3/8T BULKHEAD FITTING ST. JG

EL-FP-BPLDC824
300-1K BOOST PUMP
8-24VDC 1/2"NPT

PL-HBS-3/4X3/4
3/4" NPT X 3/4" HOSE
BARB ST. NYLON

PL-CKV-1M3/4FWS
1"MPT X 3/4" FPT
CHECK VALVE W/S

PL-CLP-114CAR
1-1/4" CARLON CLAMP

SO-STN-6SS
6" STRAINER SEAL

FT-STN-6
6" SEA STRAINER

FT-STN-6S
6" STRAINER SCREEN

SUB-STN-6WBH3/8
6" STRAINER WITH BULK
HEAD FITTING 3/8" TUBE

PL-BSH-1X1/2N
1" NPT x 1/2" FPT HEX REDUCER NYLON

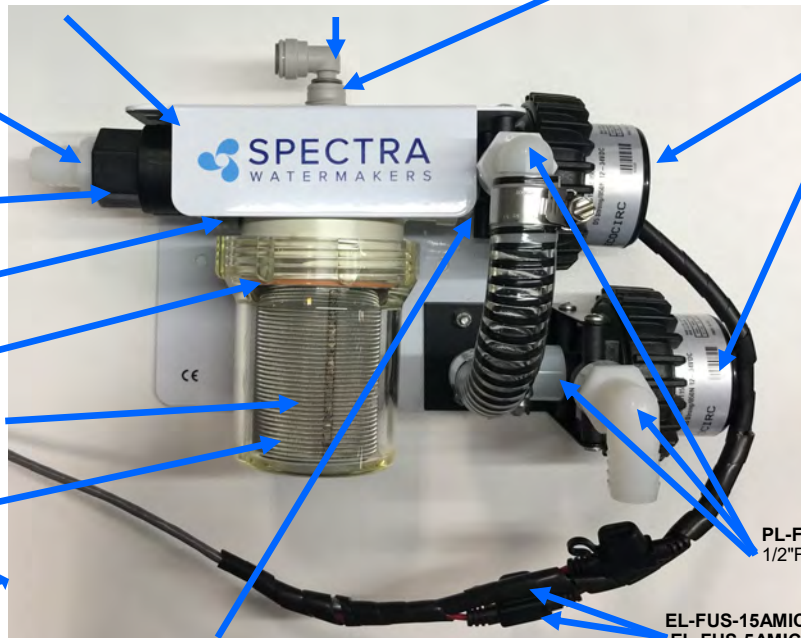

PL-FHB-1/2x3/4E
1/2"FPT x 3/4" HOSE BARB NYLON

EL-FUS-15AMICHD 15A MICRO FUSE HOLDER
EL-FUS-5AMIC2 5A MICRO2 FUSE

Newport 700/1000C & MkII-Z (October 2014)

Product Water Manifold

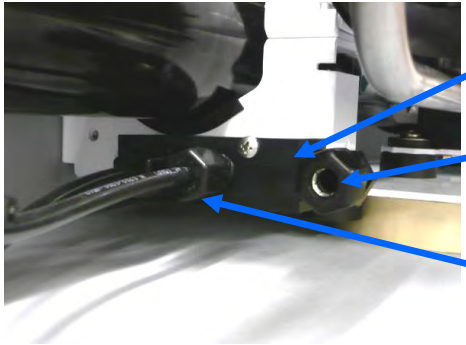

PL-MNF-PD
PRODUCT MANIFOLD
700/1000

PL-MTE-3/8X3/8J
3/8"NPT X 3/8" TUBE
FITTING ELBOW JG

PL-MTS-1/4X1/4J
1/4"NPT X 1/4" TUBE
FITTING ST. JG

Brine Discharge Quick Connect

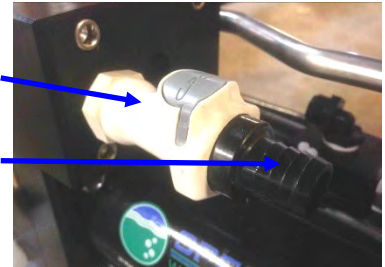

PL-QDC-BD3/8
3/8"NPT Quick Disc.
Coupling Body

PL-QDC-HB5/8
5/8" Quick Disc.
Fitting Hose Barb

High Pressure Fittings

SUB-MTS-3/8X1/2
Nickel-Bronze High Pressure Straight
Fitting

PL-HWR-1/2FR
1/2" Stainless Ferrule

SO-FT-STF
3/4"-16 Straight Thread O-RING

Complete Assembly
PL-MTS-3/8X1/2B

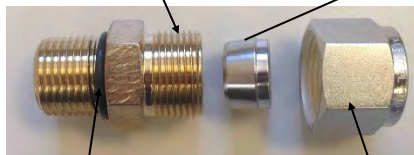

Connector O-RING
SO-HPP-CT

Stainless Fitting Hex Nut
PL-HWR-1/2HN

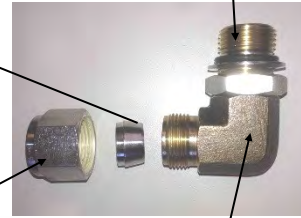

PL-MTE-3/4S1/2B
3/4"-16 ST X 1/2" Tube
Fitt. Elbow Bronze

Newport 700/1000 Connect & MkII-Z

Newport 700/1000 MkII Z Feed Pump Module (All Versions)

FM-NPC-MKII1K
NEWPORT 700/1K
MK-II CHASSIS



KIT-SC-RMPNLL SPECTRA
CONNECT REMOTE CNTRL.
DSP.4.3"(LOCAL)

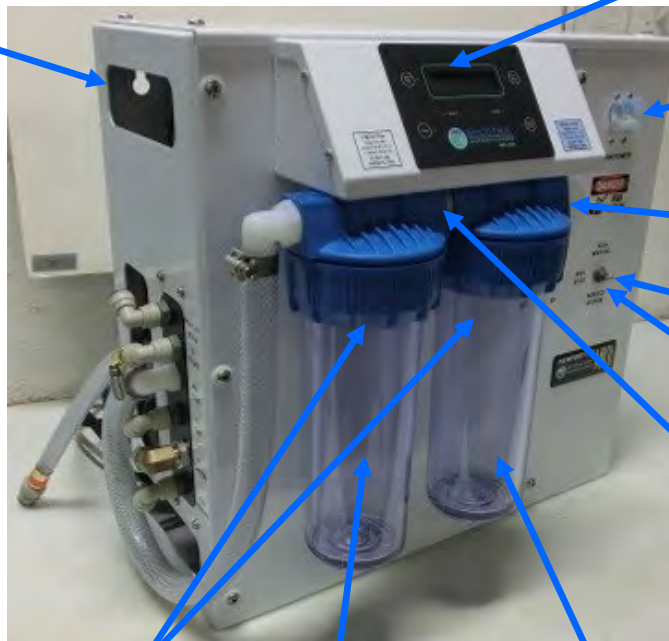

EL-MPC-RMCD
MPC REMOTE CONTROL (LCD)

EL-BRK-BRKB2P
BREAKER BOOT
PANEL MOUNTED
2 POLES

PL-HBE-3/4X3/4
3/4" NPT X 3/4" HOSE
BARB ELL NYLON

EL-SWT-TG-DPDT
TOGGLE SWITCH
DP/DT

EL-SWT-TSBHC
TOGGLE SWITCH
BOOT SEAL

PL-NP-3/4N
3/4" NPT CLOSE
NIPPLE NYLON

FT-FTH-10L3PCS
10" LOW PRESS. FILTER
HOUSING 3 PCS

FT-FTC-5
5 MICRON FILTER
ELEMENT

FT-FTC-20
20 MICRON FILTER
ELEMENT

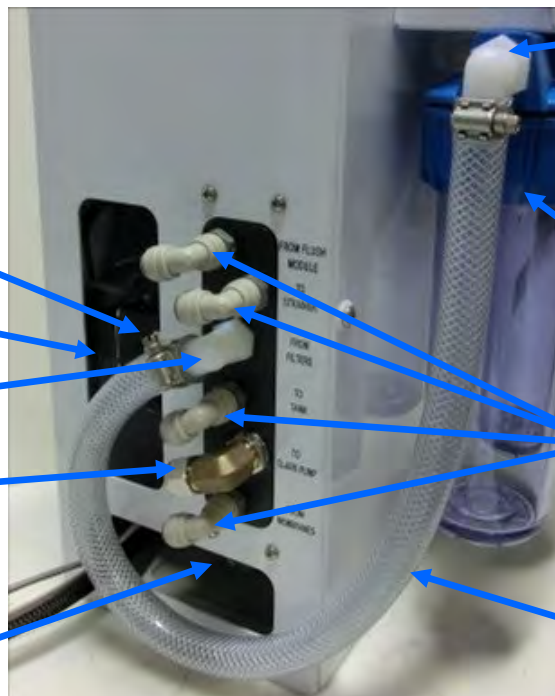

PL-HBE-3/4x3/4
3/4"NPT x 3/4" hose barb
elbow

FT-FTH-10L3PCS
10" LOW PRESS. FILTER
HOUSING 3 PCS

PL-SWF-3/8X3/8T
3/8"NPT X 3/8" TUBE
FITTING ELL JG

PL-HS-3/4VN
3/4" VINYL HOSE

PL-SLN-1/4D12M
1/4" DIVERSION
VALVE 12 V (MNF)

EL-SSR-250
PRESSURE TRANSDUCER
(250 PSI)

PL-HBE-1/2x3/4
1/2"NPT x 3/4" hose barb
elbow

PL-MTE-3/4S1/2B
3/4"-16S X 1/2" TUBE
90DEG. BRONZE

EL-MPC-SP4
SALINITY PROBE
4th GENERATION

Newport 700/1000 Connect MkII-Z

Newport 700/1000 MkII Z Feed Pump Module (All Versions) cont.



Cabling



Newport 700/1000 MkII-Z

Newport 700/1000 MkII Z Feed Pump Module (AC Versions)

For 110 AC:
EL-MTR-SPCAC110
3/4 MOTOR SPEED CONTROLLER AC 110
For 220 AC:
EL-MTR-SPCAC220
3/4 MOTOR SPEED CONTROLLER AC 220

For 110AC:
EL-BRK-15ADP
AC/DC BREAKER DP TOGGLE 15A
For 220AC:
EL-BRK-10AACFP
AC/DC BREAKER DP TOGGLE 10A

EL-TM-30A4
TERMINAL BLOCK
30A 4 POS.

EL-SWT-TG-DPDT
TOGGLE SWITCH DP/DT

EL-PS-24V150W
24V 6.5A POWER
SUPPLY 110/220 IN

EL-MPC-PCBDPA40
MPC-5000 CIRCUIT
BOARD

EL-HWR-DPG
DIAPHRAM
GROMMET PVC
BLACK

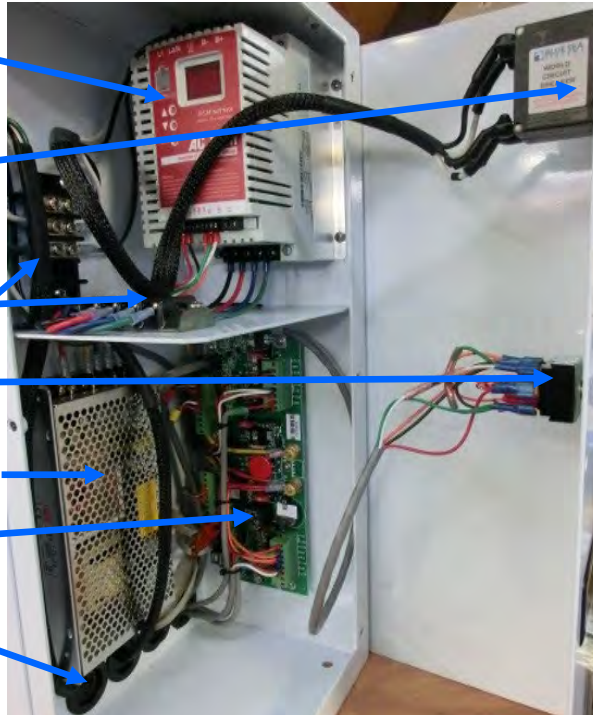

EL-MTR-3/4AC220
3/4 HP, 240 VAC,
3 PHASE, 56C MOTOR



Newport 700/1000 Connect & MkII-Z

Newport 700/1000 MkII Z Feed Pump Module (24-Volt DC Version)

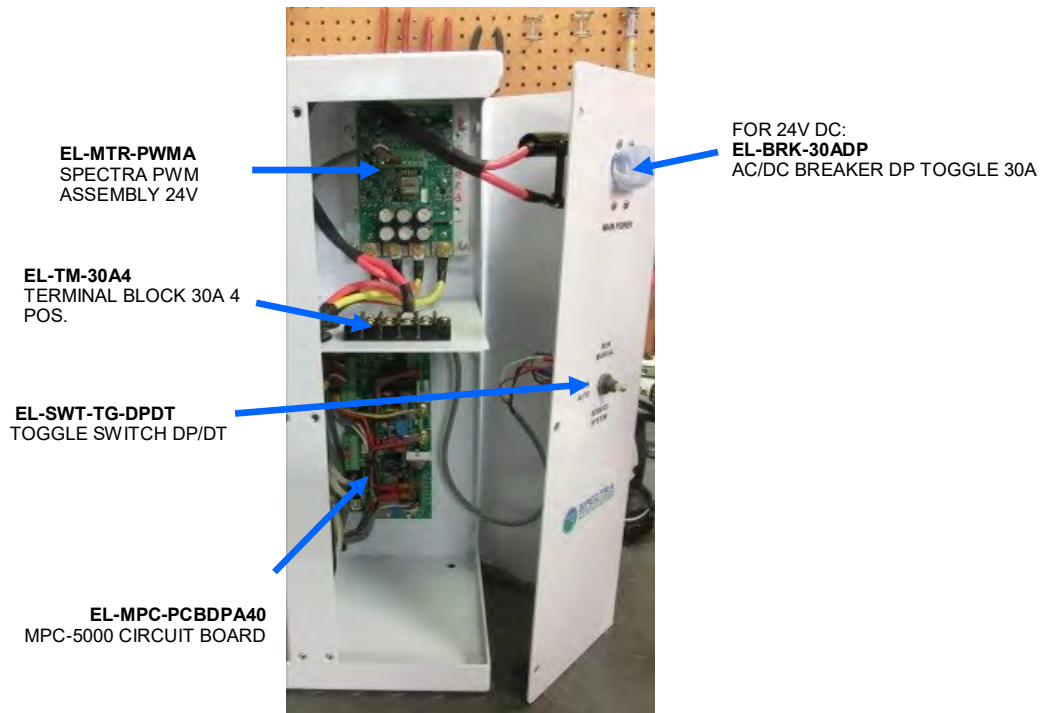
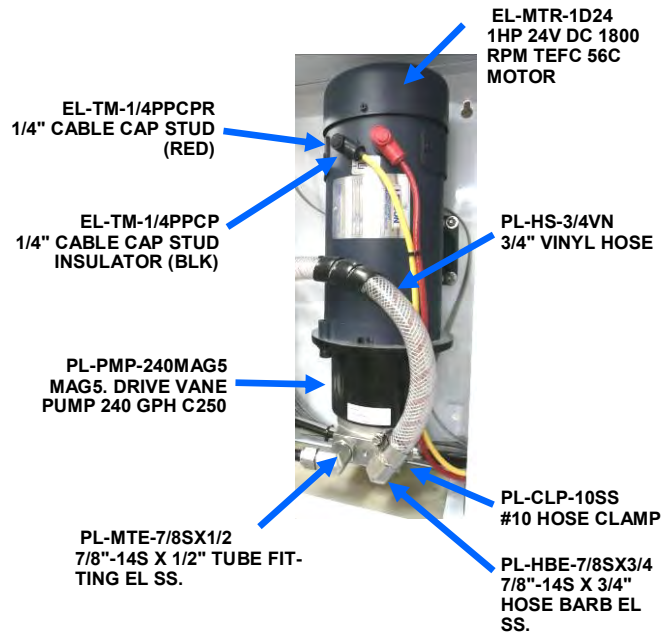

Newport 700/1000 Connect & MkII-Z

Fresh Water Flush Module or Z-Ion

Fresh water flush module without Z-Ion will have the same parts, minus modified filter bowl and electronic box on top.

PL-BSH-3/4X1/4N
3/4" X 1/4" HEX
BUSHING REDUCER NYLON

PL-VLV-1/4FMELP
1/4" F-M PVC VALVE
ELBOW

PL-HBS-1/4X1/2
1/4" NPT X 1/2" HOSE
BARB ST. NYLON

FT-FTH-10L3PCS
10" LOW PRESS. FILTER
HOUSING 3 PCS (without Z-
ION)



PL-MFF-3/4X3/4
3/4" NPT X 3/4" FPT ELBOW
FITTING NYLON

PL-NP-3/4x1/2N
3/4" NPTx1/2"NPT CLOSE
NIPPLE NYLON

PL-FRG-1/2MF1.5
1/2" NPT-FPT FLOW REG.
1.5G 20-80P

PL-FTS-1/2x3/8P
1/2" FPT x 3/8" TUBE
STRAIGHT

FT-FTC-CC
CHARCOAL FILTER
(inside housing, not shown)

Hoses and Tubes

PL-HS-3/4SH
3/4" REINFORCED SUC-
TION HOSE

PL-HS-5/8VN
5/8" VINYL HOSE

PL-NLT-1/4LP
1/4" Low Pressure Tube
(Product)

PL-NLT-3/8LPB
3/8" Blue Low Pressure
Tube(Product)

PL-HS-3/4VN
3/4" VINYL HOSE

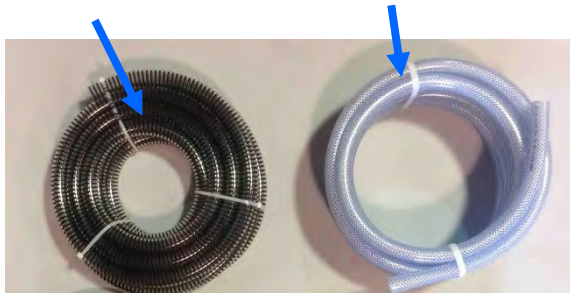

SUB-NP-MK2-ILHA
NP MK-II 700/1K Inlet Hose
Assembly (10-foot)

PL-HS-3/4PVCGR
Hose w/o end fittings



PL-NLT-3/8LP
3/8" Low Pressure
Tube (Flush)

PL-NLT-1/2LP
1/2" LOW PRES-
SURE TUBING

PL-HS-1/2VN
1/2" VINYL HOSE

Quick Disconnect Pigtail (installed at "to strainer" fitting on feed pump)



PL-HBA-3/8Tx1/2
3/8" T STEM x 1/2"
HOSE BARB ADAP.

PL-HF-.75IDX1BR
Brass ferrules for 1/2-inch hose

PL-HS-1/2VN
1/2" VINYL
HOSE

PL-QDC-1/2HBISV
1/2" HB QUICK DISCT.
INSERT w/ VALVE

Farallon 1800/2800 Part Numbers

PL-CKV-3/4F-FWS
3/4" FPT CHECK VALVE W/1/3# HAST.SPR

PL-SLN-3W220AC
1/2"NPT 3-WAYSOLENOID 9/16" 220AC

PL-NLT-1/2HP
1/2" HIGH PRESSURE TUBE

1/2" HIGH PRESSURE HOSE
(GREEN)

SP5 Pearson Pump
Farallon 1800 - (20%)
Farallon 2800 - (30%)

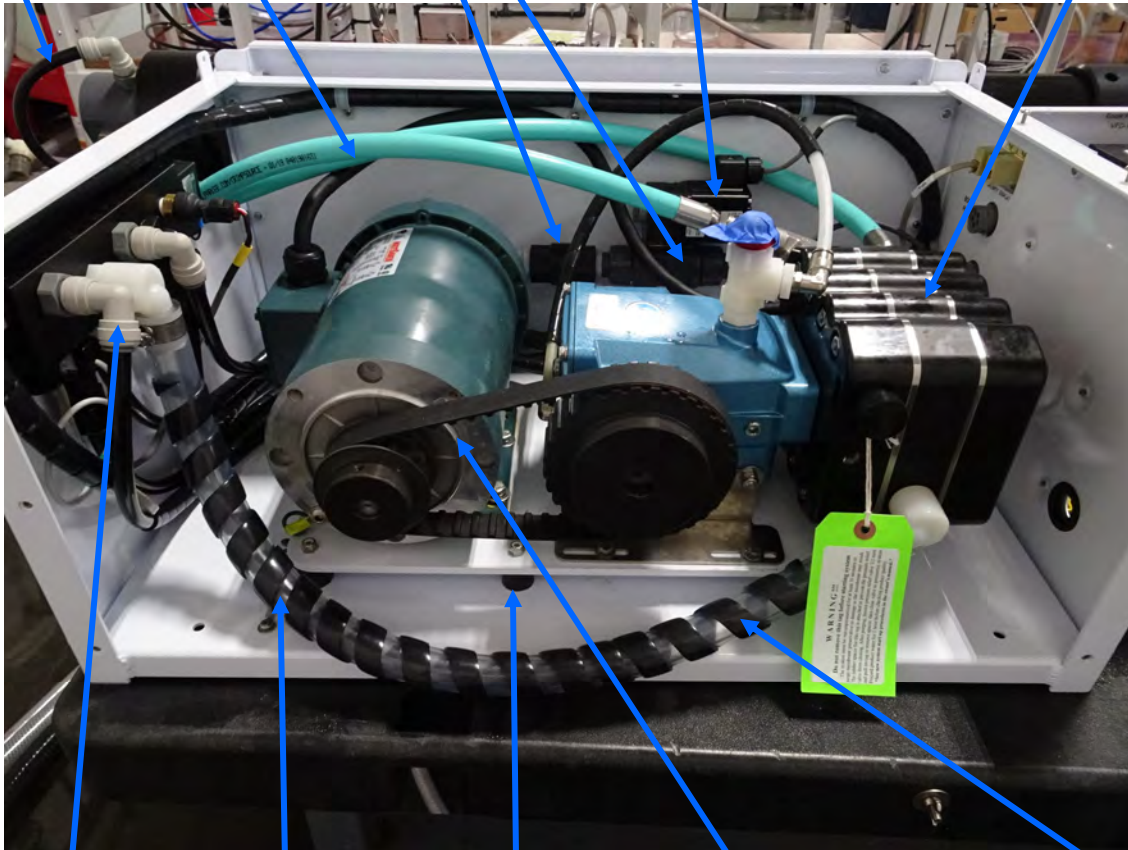

PL-MNF-FINL
FARALLON INLET
MANIFOLD FOR
SPARTAN

PL-HS-3/4PVCCLP
3/4" PVC HOSE CLEAR
LOW PRESSURE

EL-MTR-2HP220AC
2 H.P. MOTOR 220AC 3PH
1750 RPM

EL-LT-3/4SW
3/4" SPIRAL WRAP

HD-HWR-VDM1
1" DIA X 1" H VIBRATION DAMPING MNT.

Farallon 1800/2800 Part Numbers

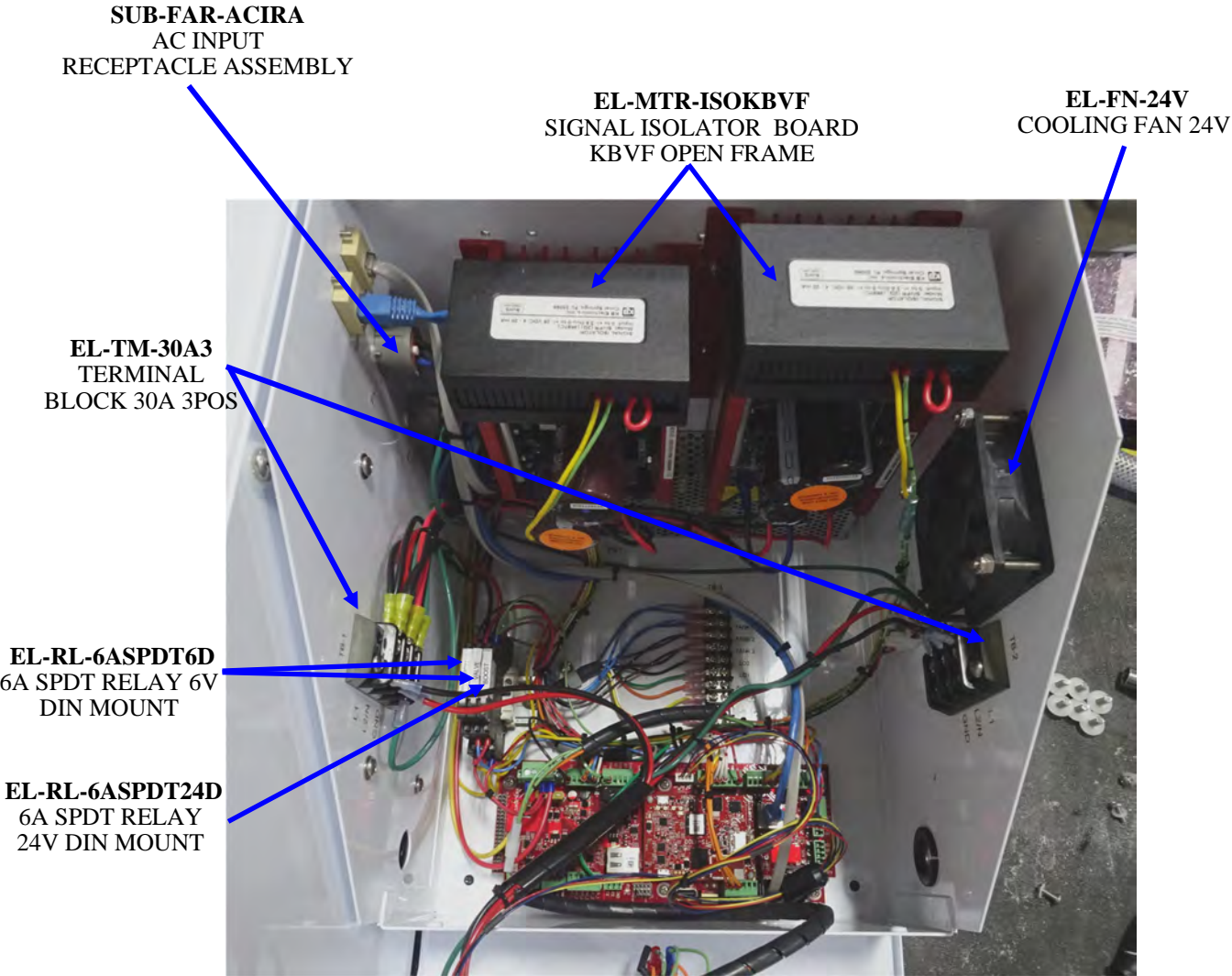

Farallon 1800/2800 Part Numbers

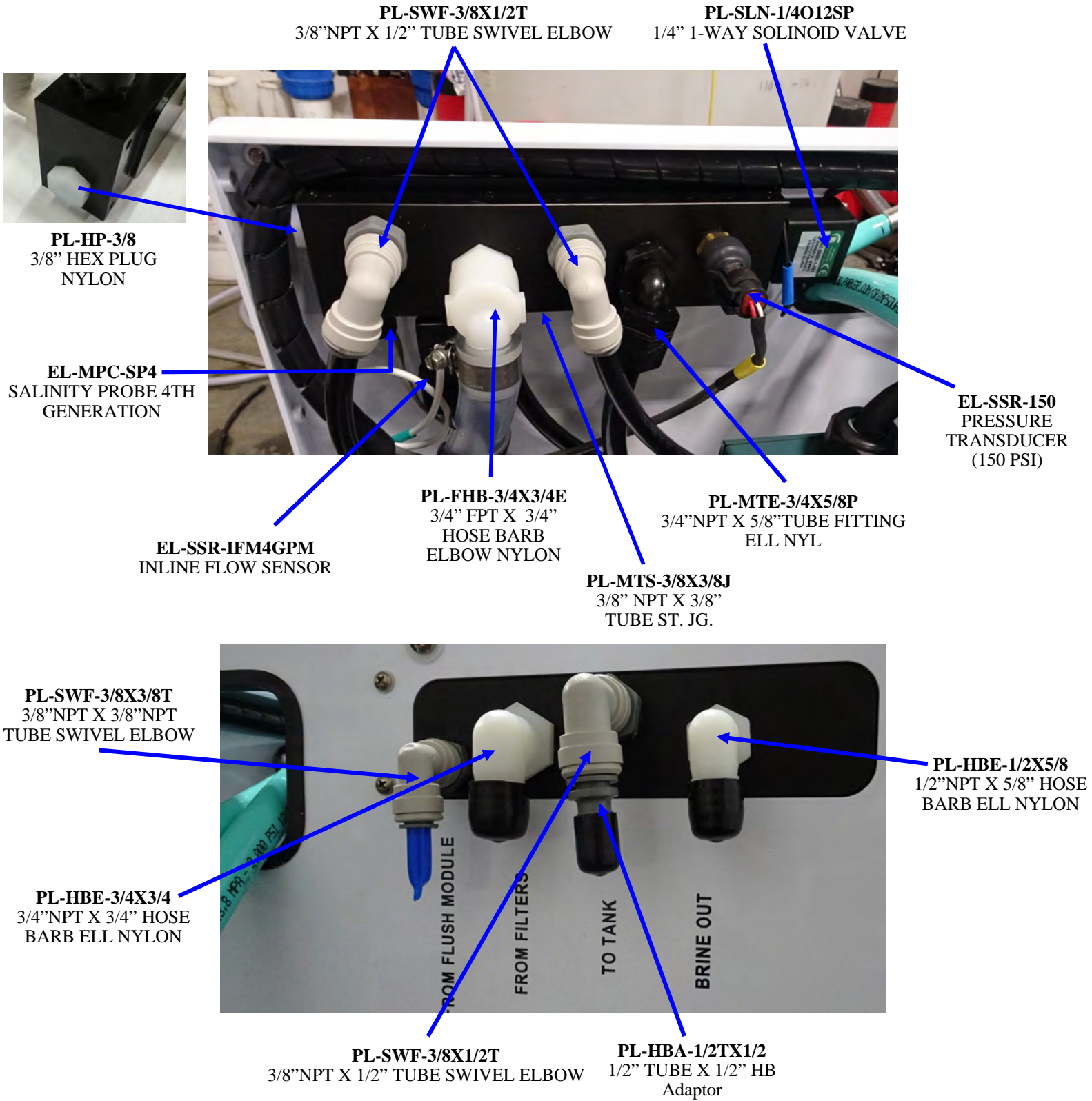

PL-SWF-3/8X1/2T
3/8"NPT X 1/2" TUBE SWIVEL ELBOW

PL-SLN-1/4O12SP
1/4" 1-WAY SOLINOID VALVE

PL-HP-3/8
3/8" HEX PLUG
NYLON

EL-MPC-SP4
SALINITY PROBE 4TH
GENERATION

EL-SSR-150
PRESSURE
TRANSDUCER
(150 PSI)

EL-SSR-IFM4GPM
INLINE FLOW SENSOR

PL-FHB-3/4X3/4E
3/4" FPT X 3/4"
HOSE BARB
ELBOW NYLON

PL-MTE-3/4X5/8P
3/4"NPT X 5/8" TUBE FITTING
ELL NYL

PL-MTS-3/8X3/8J
3/8" NPT X 3/8"
TUBE ST. JG.

PL-SWF-3/8X3/8T
3/8"NPT X 3/8"NPT
TUBE SWIVEL ELBOW

PL-HBE-1/2X5/8
1/2"NPT X 5/8" HOSE
BARB ELL NYLON

PL-HBE-3/4X3/4
3/4"NPT X 3/4" HOSE
BARB ELL NYLON

PL-SWF-3/8X1/2T
3/8"NPT X 1/2" TUBE SWIVEL ELBOW

PL-HBA-1/2TX1/2
1/2" TUBE X 1/2" HB
Adaptor

Farallon 1800/2800 Part Numbers

EL-BRK-10AACFP
10A AC BREAKER DOUBLE POLE

EL-BRK-BRKB2P
BREAKER BOOT PANEL
MOUNTED 2 POLES

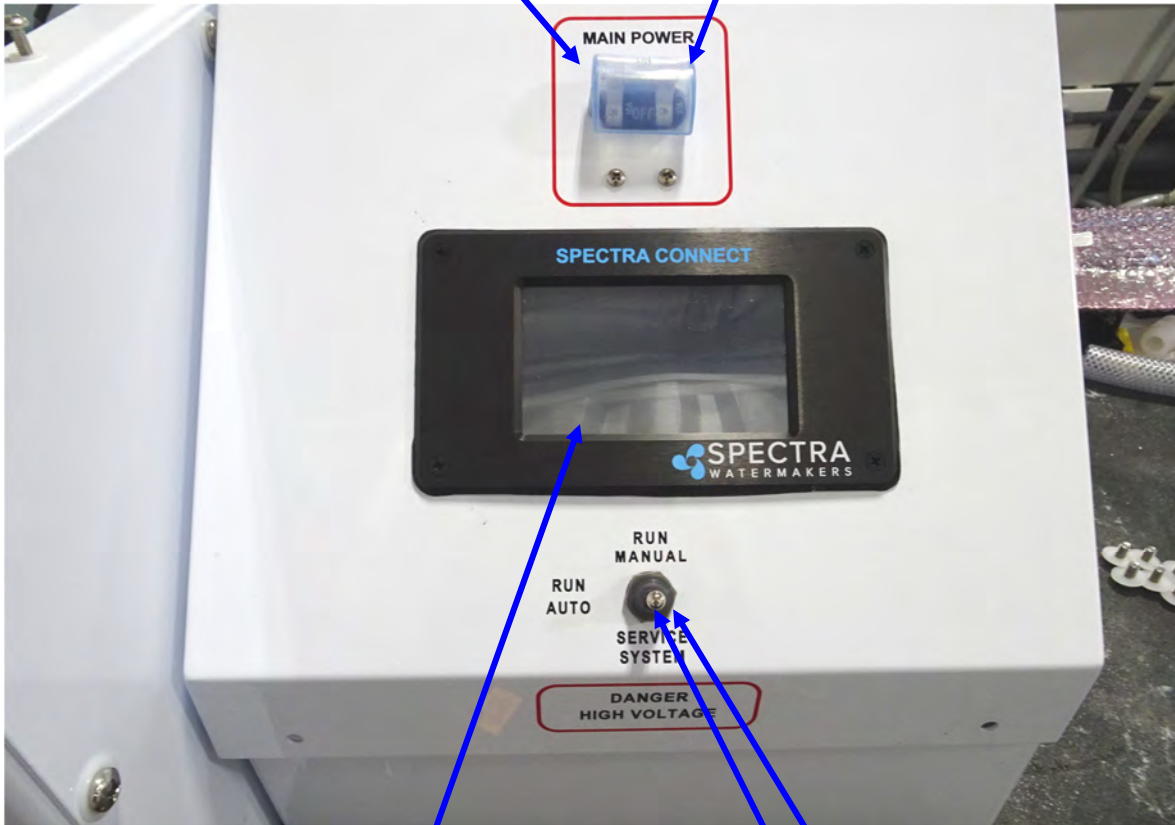

FM-NPC-SCDC
NEWPORT-400/700/1000 SP CONNECT
DISPLAY

EL-SWT-TSBHC
TOGGLE SWITCH BOOT SEAL

EL-SWT-TG-DPDT
TOGGLE SWITCH DP/DT

Farallon 1800/2800 Part Numbers

FT-PV-ER4IN
SPECTRA PRESSURE VESSEL END RING 4"

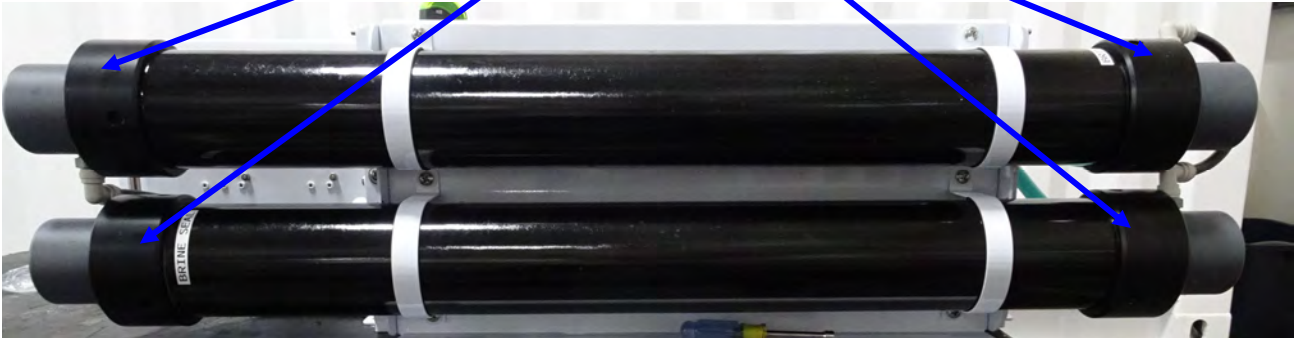

1/2" HIGH PRESSURE HOSE (GREEN)

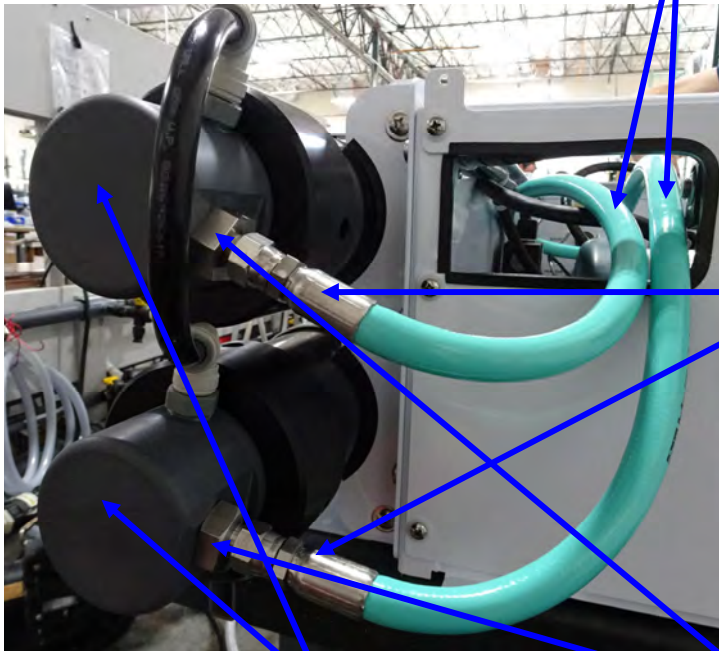

PL-FFS-1/2HBSS
1/2" FP SWIVEL 37 FLARE 1/2"H SS

FT-PV-EC4IN
SPECTRA 4" PRESSURE VESSEL END CAP

PL-MFS-11/16S12
1-1/16"S X 1/2" 37DEG FITT ST. SS

Farallon 1800/2800 Part Numbers

PL-MTS-11/16S12
M/C 1-1/16" S X 1/2" TUBE ST

PL-SWF-1/2X1/2
1/2" NPT X 1/2" TUBE SWIVEL FITT ELL

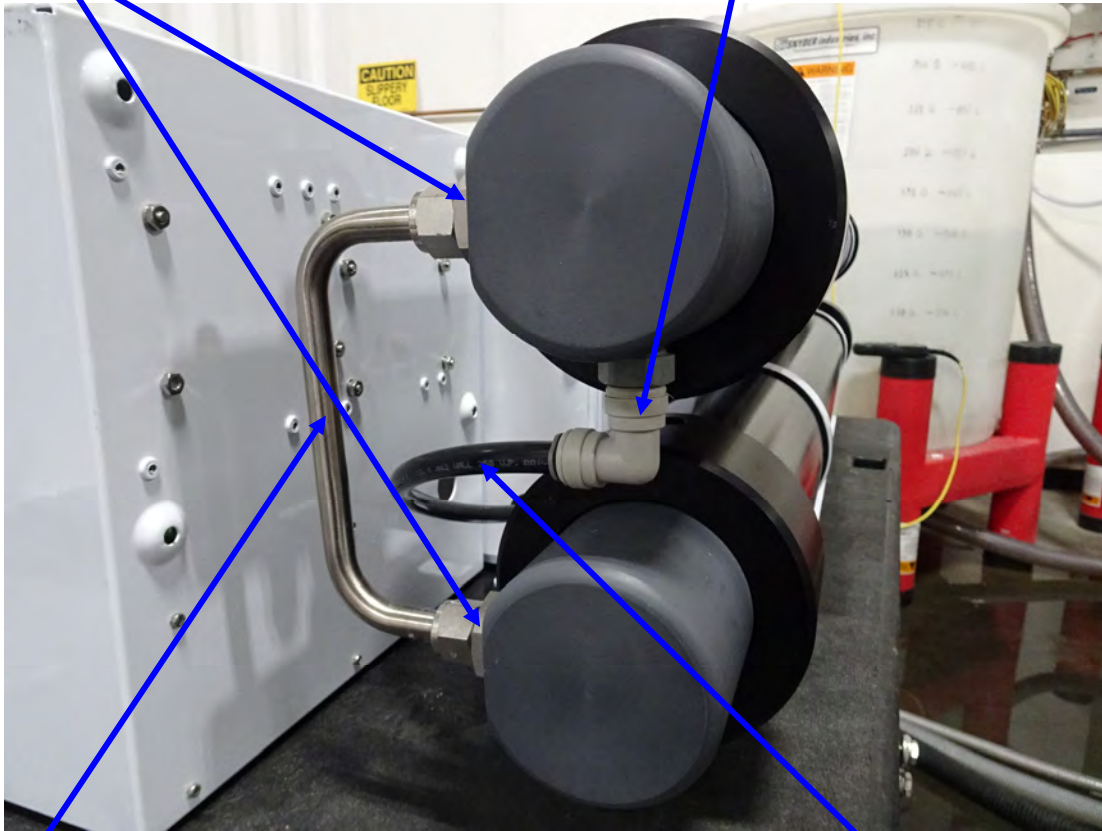

PL-TB-UTC4V
U-TUBE FOR 4" PRESS. VESSEL.

PL-NLT-1/2LP
1/2" LOW PRESSURE TUBE

Farallon 1800/2800 Part Numbers

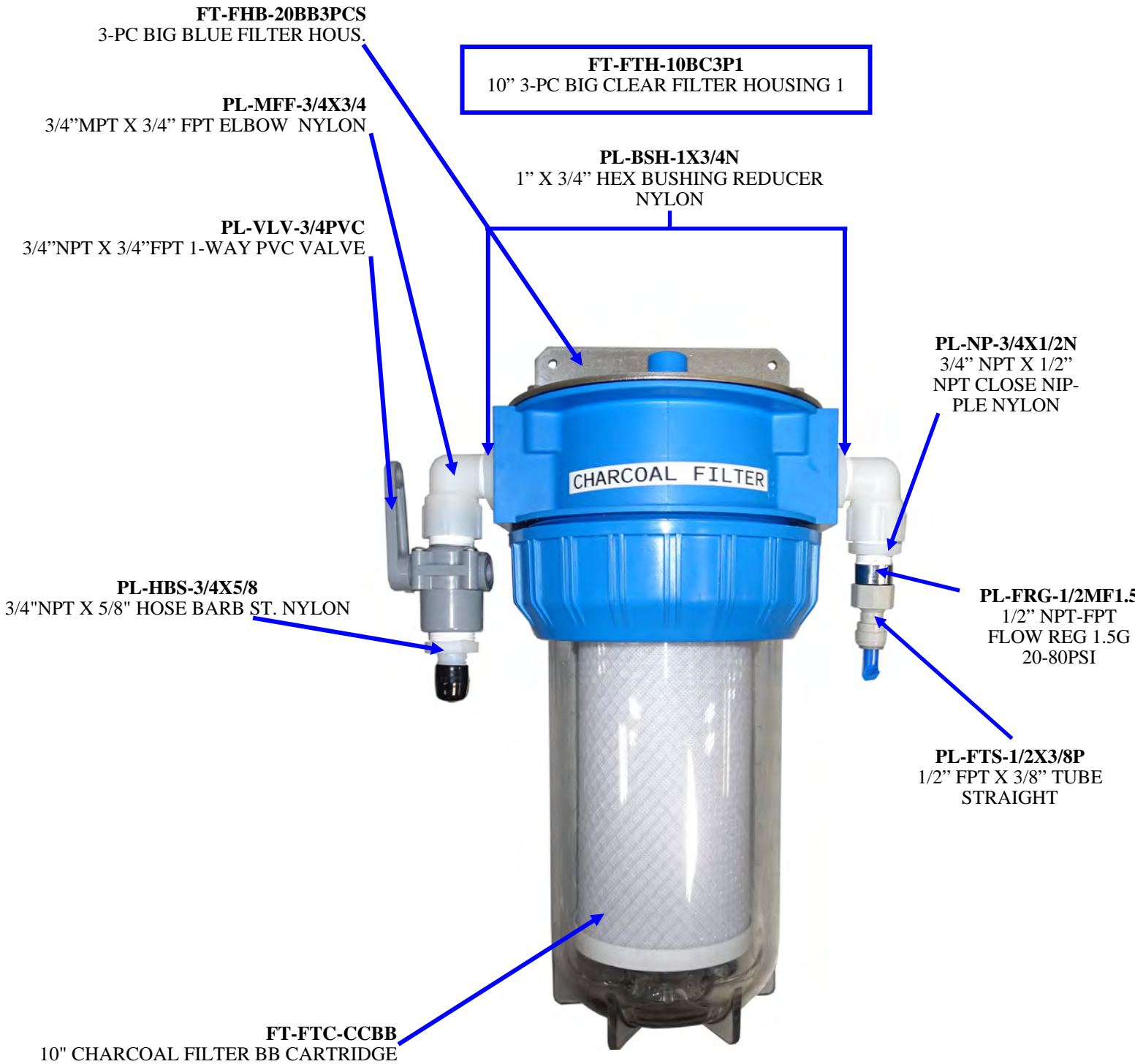

Farallon 1800/2800 Part Numbers

PL-HBE-1X1/2N
1"NPT X 1/2" HOSE BARB EL. NYLON

FT-FTH-10BC3P1
10" 3-PC BIG CLEAR FILTER HOUSING 1

FT-FHB-20BB3PCS
3-PC BIG BLUE FILTER HOUS. BRACKET



FT-FTC-20BB
20 MICRON BIG BLUE FILTER
CARTRIDGE

FT-FTC-5BB
5 MICRON BIG BLUE FILTER
CARTRIDGE

PL-NP-1N
1"NPT HEX CLOSE NIPPLE NYLON

Farallon 1800/2800 Part Numbers

**EL-FP-BP8GPM220
8 GPM 220/60 BOOSTER PUMP**

**PL-FHB-3/4X3/4
3/4" FPT X 3/4" HOSE BARB
ST. NYLON**



**PL-CLP-10SS
#10 HOSE CLAMP**

Farallon 1800/2800 Part Numbers

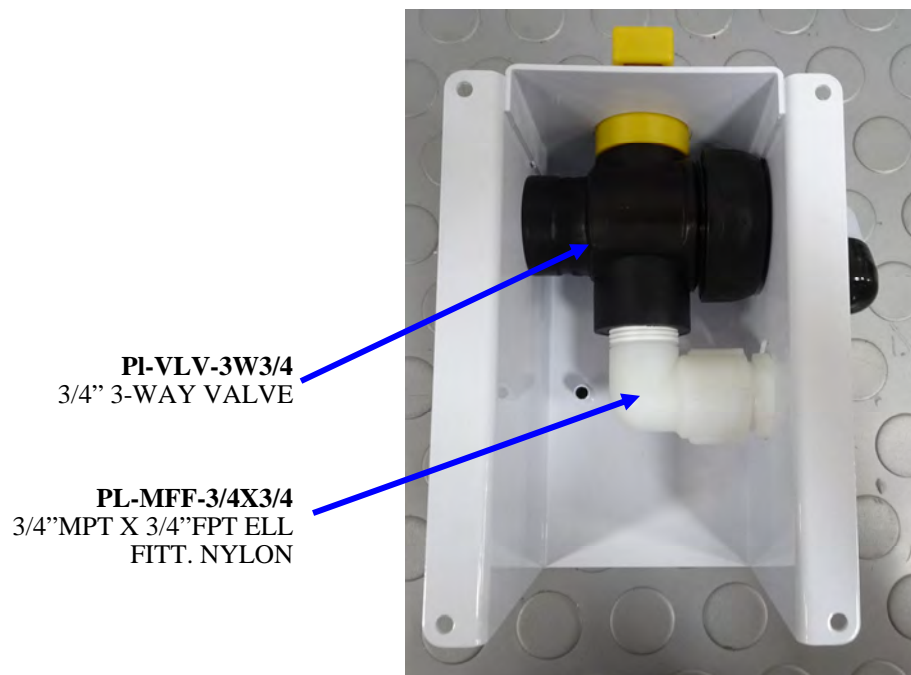
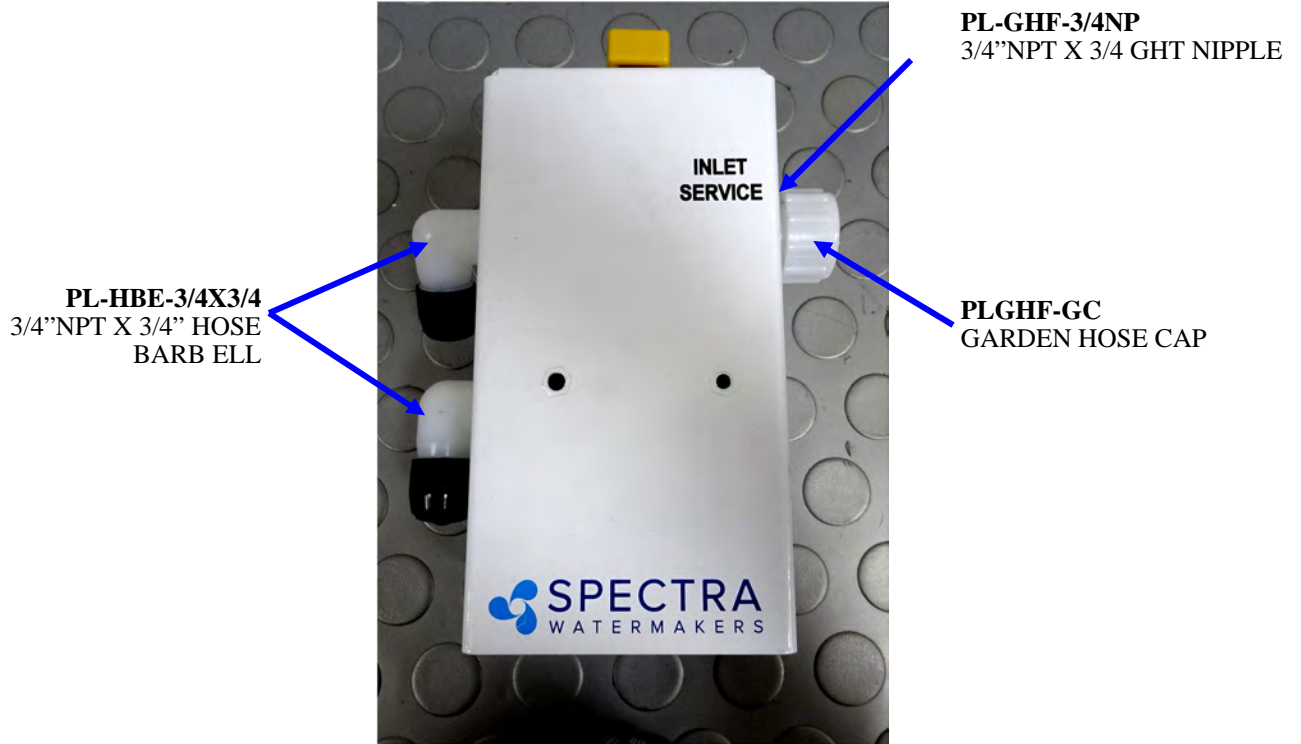

Farallon 1800/2800 Part Numbers

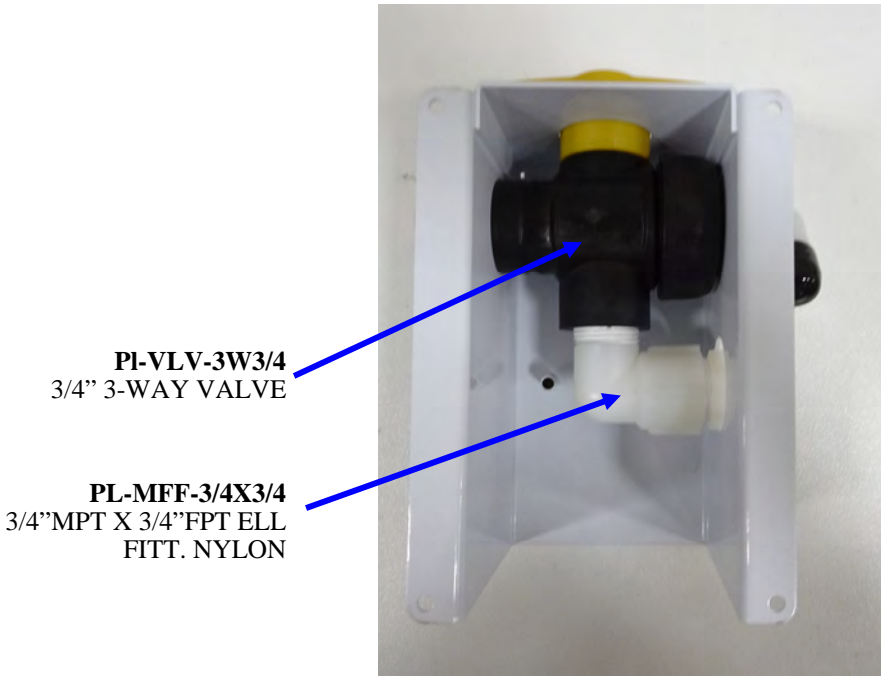
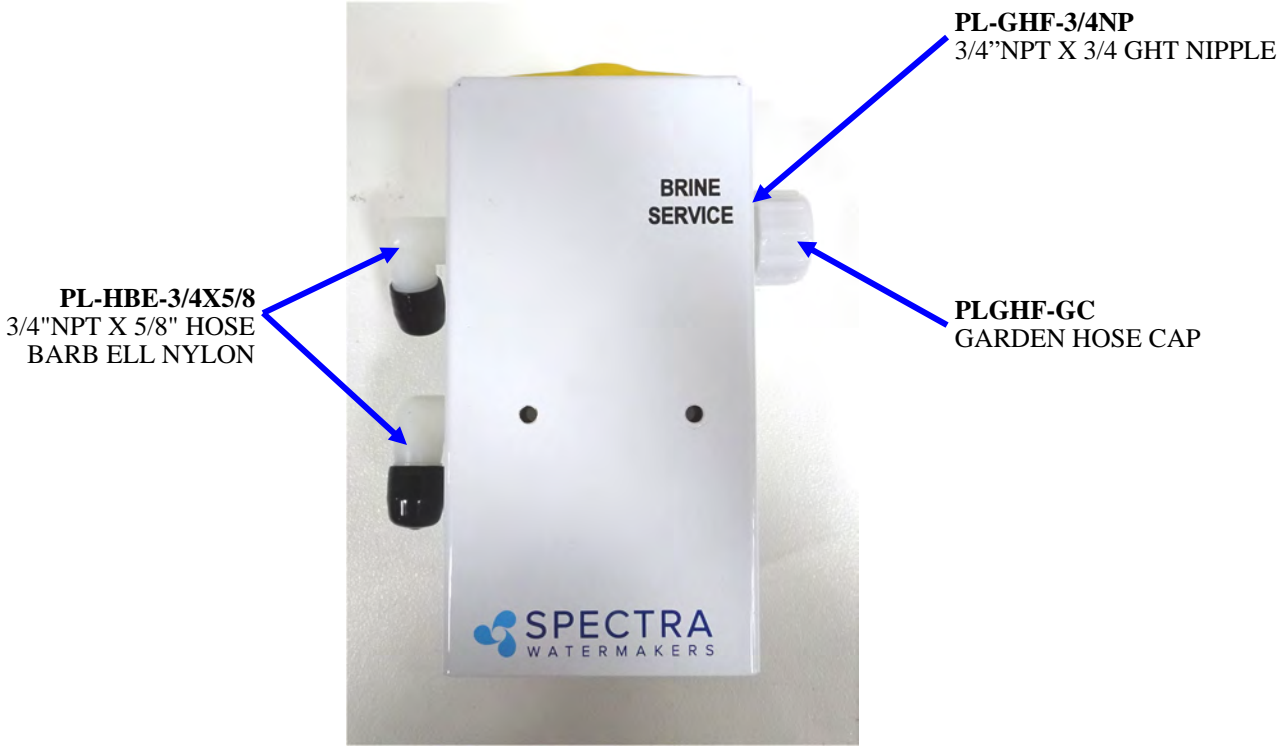

Farallon 1800/2800 Part Numbers

Sea Strainer Assembly

FT-FHB-10HD
HIGH PRESS. HOUSING
BRACKET DUPLEX

PL-NP-3/4N
"3/4"" NPT CLOSE
NIPPLE NYLON"

PL-CKV-3/4F-FW
"3/4""FPT CHECK VALVE
W/1/3# HAST.SPR"

PL-HBS-1X3/4N
"1"" NPT X 3/4""
HOSE BARB ST
NYLON"

PL-HBS-1X3/4N
"1"" NPT X 3/4""
HOSE BARB ST
NYLON"



FT-STN-6
"6""
STRAINER
(LARGE)"

PL-BSH-1X3/4N
"1"" X 3/4"" HEX
BUSHING
REDUCER
NYLON"

Farallon 1800/2800 Part Numbers



CATALINA 300 MK II

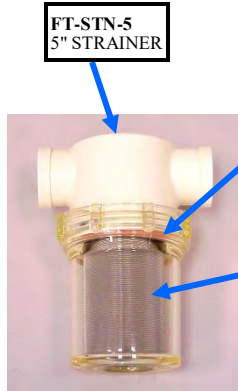

FT-STN-5
5" STRAINER

SO-STN-5SS
SEA STRAINER
GASKET

FT-STN-5S
5" STRAINER
SCREEN
(SMALL)

PL-VLV-3/4PVC
3/4"NPT X 3/4"FPT 1-WAY PVC VALVE

PL-BSH-3/4X1/4N
3/4" X 1/4" HEX
BUSHING REDUCER NYL

PL-MFF-1/4X1/4
1/4"NPT X 1/4"FPT ELBOW
NYL

PL-NP-1/4N
1/4" NPT CLOSE NIPPLE

PL-PRG-1/4P
1/4" WATER PRESSURE
REGULATOR

PL-HBS-1/4X1/2
1/4" NPT X 1/2" HOSE
BARB ST. NYLON

FT-FTH-10L3PCS
10" LOW PRESS. FILTER HOUSING 3 PCS

3 PIECE FILTER HOUSING WRENCH
FT-FHW-3PCS

PL-MTE-3/4X3/8P
3/4 NPT X 3/8" TUBE
ELBOW NYLON

FT-FC-CC
CHARCOAL FILTER

FM-NPC-SVBM
NEWPORT II SERVICE &
BOOST MODULE



PL-GHF-GC
GARDEN HOSE CAP
PL-GHF-WS
GARDEN HOSE WASHER VINYL
PL-GHF-3/4NP
3/4"NPT X 3/4"GHT NIPPLE

PL-VLV-3W3/4
3/4" 3-WAY VALVE

PL-FHB-3/4X3/4
3/4"FPT X 3/4 HOSE BARB
ST. NYLON

PL-MTE-1/2X1/2P
1/2" NPT X 1/2" TUBE ELL

PL-ACC-TK
ACCUMULATOR TANK

EL-SSR-150
150 PSI PRESSURE SENSOR

PL-NLT-3/8LP
3/8" LOW PRESSURE
TUBING

PL-MTS-1/4X3/8T
1/4" NPT X 3/8"
TUBE FITTING

***PL-SLN-1/4012-NLA**
12V FRESH WATER
FLUSH SLOENOID

EL-MTR-1/6D12
12 VDC MOTOR
EL-MTR-1/6D24
24VDC MOTOR

EL-SSR-ABS
ABSOLUTE PRESSURE
SENSOR

PL-NP-3/8N
3/8" CLOSE NIPPLE
NYLON

PL-PMP-100MAG
CATALINA MAG DRIVE PUMP

PL-TEE-1/2F1/4G
1/2" X 1/4" NYLON
GAUGE TEE



PL-MTE-3/8X1/2P
3/8" NPT X 1/2" TUBE FIT-
TING

PL-MTE-1/4X3/8
1/4"NPT X 3/8" TUBE
FITTING

PL-HBS-1/2X5/8
1/2" NPT X 5/8
HOSE NYLON

PL-TEE-3/8PP
3/8" FPT TEE

PL-HS-5/8
5/8" NYLON BRAID-
ED HOSE

CATALINA 300 MK II

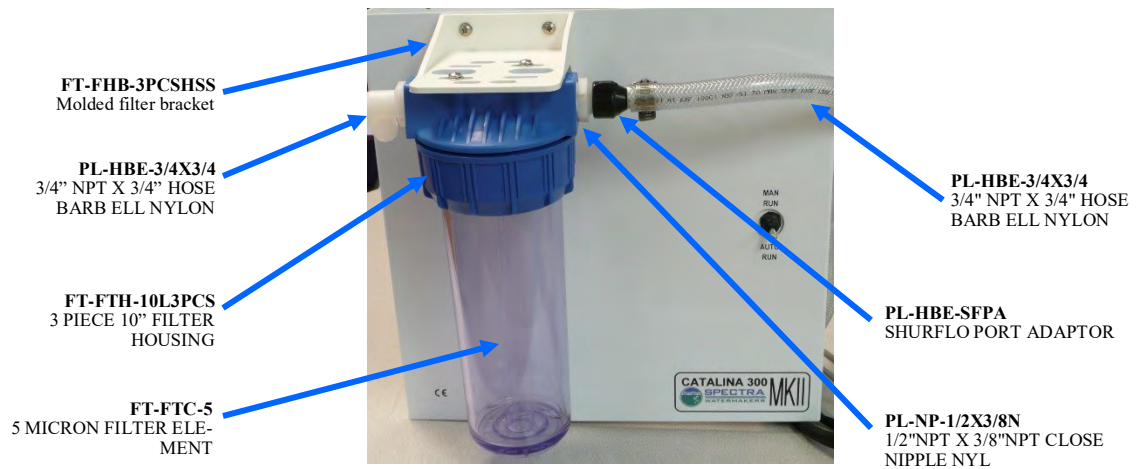
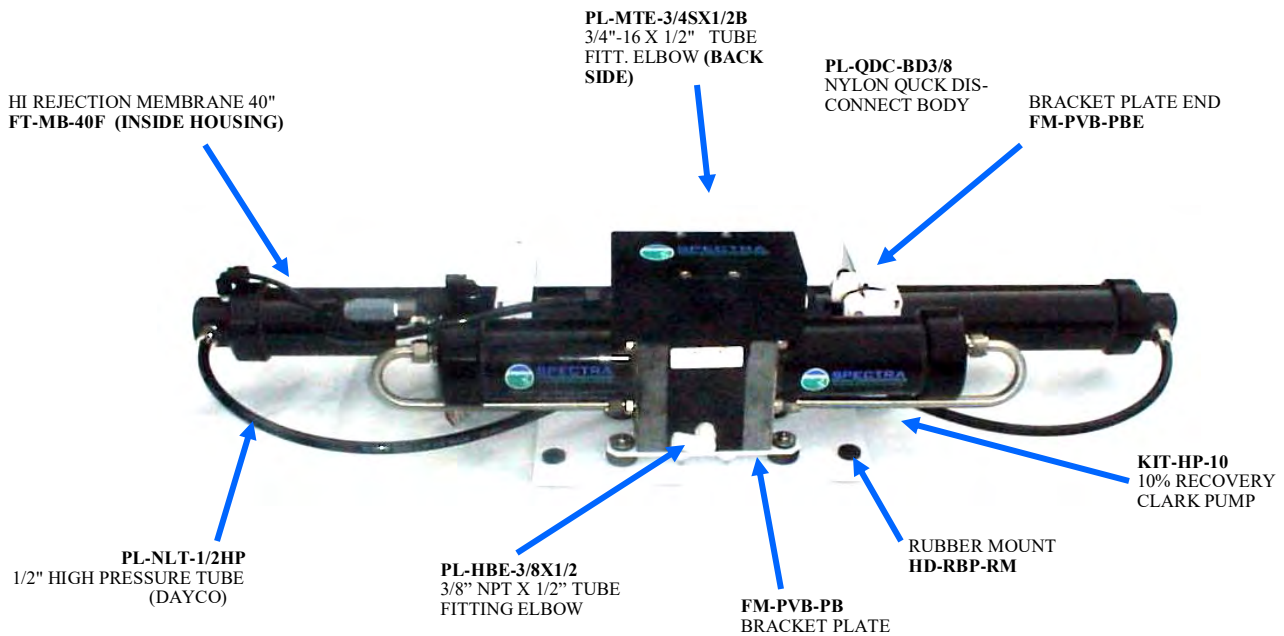

CATALINA 300 MK II

KIT-NP-MK2-BPM1 NEWPORT II SERVICE & BOOST MODULE



- PL-MFF-3/4X3/4**
3/4" MPT X 3/4" FPT ELBOW FITT.
NYLON
- PL-VLV-3W3/4**
3/4" 3-WAY VALVE
- PL-HBE-3/4X3/4**
3/4" NPT X 3/4" HOSE BARB EL NYLON
- PL-CLP-10SS**
#10 HOSE CLAMP
- PL-HS-3/4VN**
3/4" VINYL HOSE
- EL-FP-BPLDC824**
4 GPM BOOSTER PUMP DC 8-24V
- PL-FHB-3/4X3/4**
3/4" FPT X 3/4 HOSE BARB ST. NYLON

PL-NP-3/4X5
3/4" NPT X 4.5" NIPPLE POLY

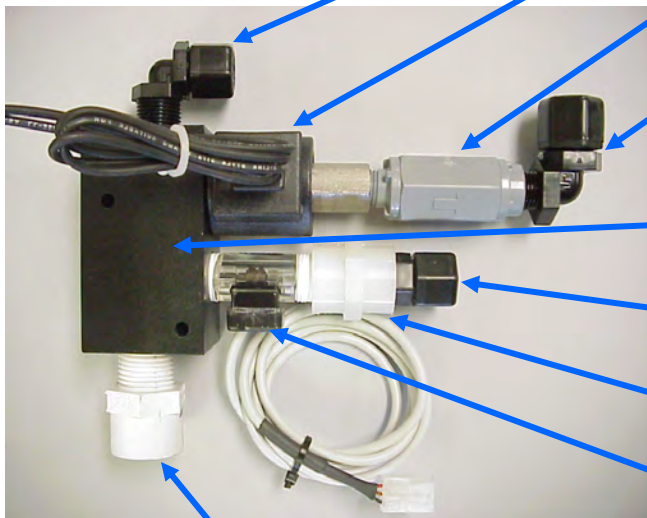

- 3/8" NPT X 1/4" Tube Fitting
PL-MTE-3/8X1/4J
- 1/4" Diversion Valve W/O VB 12V,24V
PL-SLN-1/4D12,24
- 1/4" Check Valve
PL-CKV-1/4M-F
- 1/4" NPT X 3/8" Tube Fitting
PL-MTE-1/4X3/8J
- Product Diversion Valve Manifold
SUB-NP-DVM
- 1/4" NPT X 1/4" tube fitting
PL-MTS-1/4X1/4J
- Reducing Bushing
PL-UNN-3/81/4N
- RotoFlow meter
EL-SSR-IFM

Salinity Probe
EL-MPC-SP (up to A31)
EL-MPC-SP4 (from A-34)

CATALINA 300 MK II

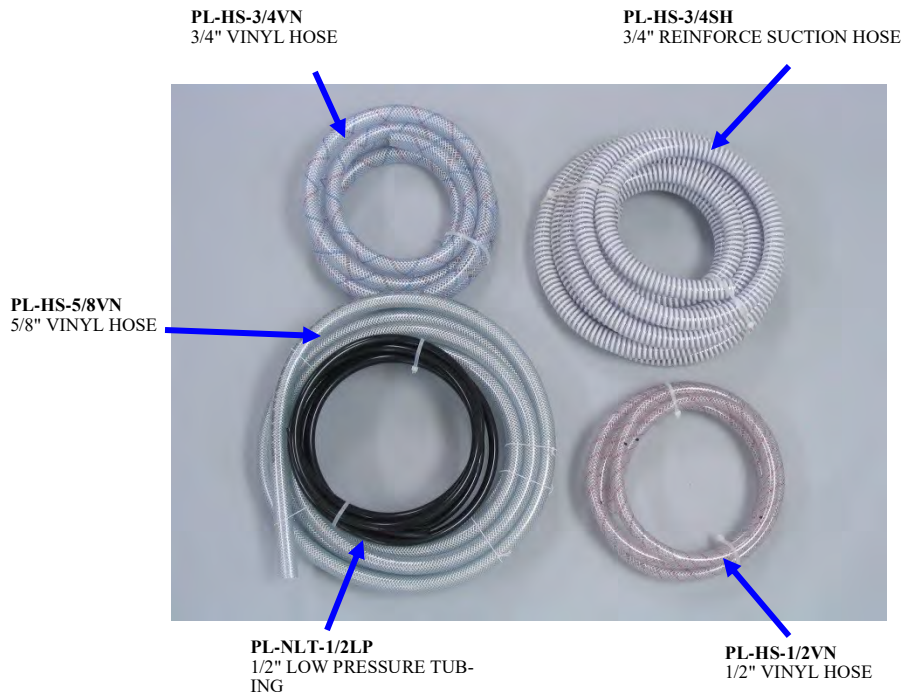
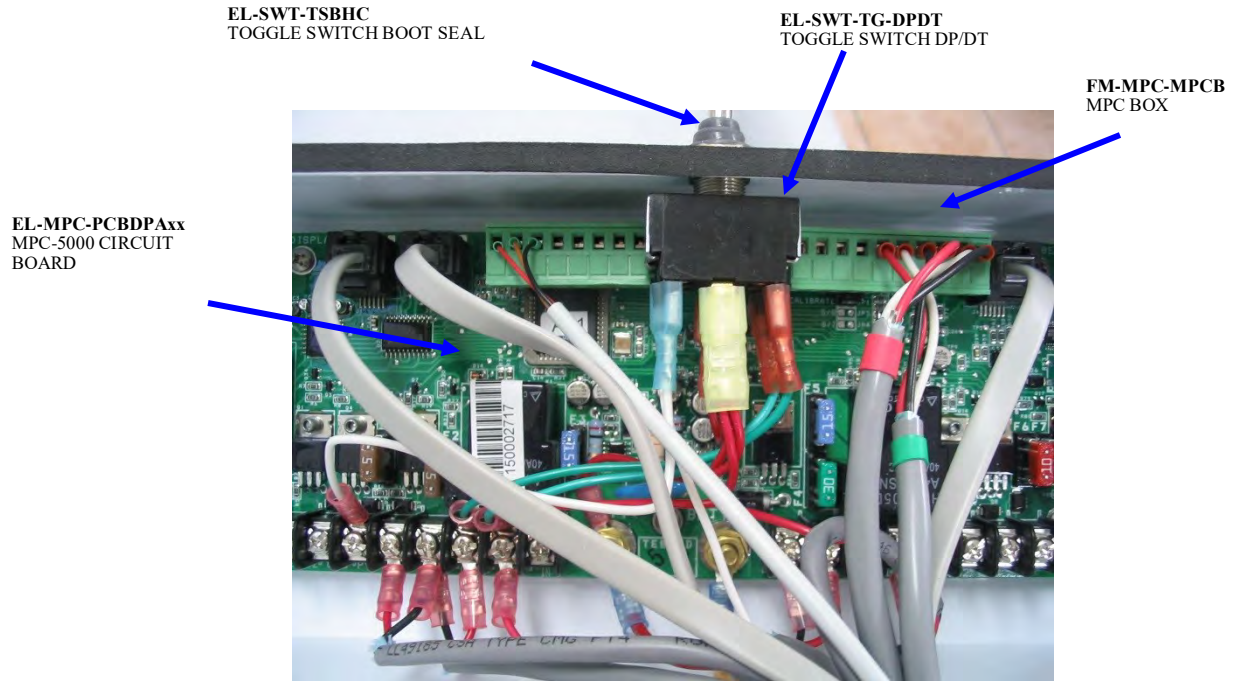

NEWPORT-400 MK II

FT-STN-6
6" STRAINER
ASSEMBLY

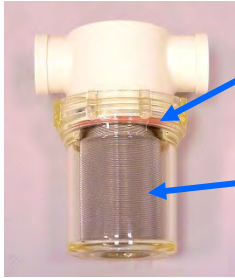

SO-STN-6SS
STRAINER
SEAL

FT-STN-6S
6" STRAINER
SCREEN

PL-BSH-3/4X1/4N
3/4" X 1/4" HEX BUSHING
REDUCER NYL

PL-VLV-3/4PVC
3/4"NPT X 3/4"FPT 1-WAY
PVC VALVE

PL-MFF-1/4X1/4
1/4"NPT X 1/4"FPT ELBOW
FITTING NYL

PL-NP-1/4N
1/4" NPT CLOSE NIPPLE

PL-PRG-1/4P
1/4" WATER PRESSURE
REGULATOR

PL-HBS-1/4X1/2
1/4" NPT X 1/2" HOSE
BARB ST. NYLON

PL-MTE-3/4X3/8
3/4 NPT X 3/8" TUBE
FITTING ELL. NYLON

FT-FTH-10L3PCS
10" LOW PRESS. FILTER HOUSING 3 PCS

KIT-NP-MK2-BPM1
NEWPORT II SERVICE & BOOST MODULE

FT-FTC-CC
CHARCOAL FILTER



PL-VLV-3W3/4
3/4" 3-WAY VALVE

EL-FP-BPLDC824
4 GPM BOOSTER PUMP DC 8-24V
INSIDE BOX

PL-FHB-3/4X3/4
3/4"FPT X 3/4 HOSE BARB
ST. NYLON

FM-MPC-MPCB
MPC BOX

FM-NPC-MKIIFBK
NEWPORT MARK IIA
FILTER BRACKET

PL-GHF-GC
GARDEN HOSE CAP
&
PL-GHF-WS
GARDEN HOSE WASHER
VINYL
&
PL-GHF-3/4NP
3/4"NPT X 3/4"GHT NIPPLE

PL-NP-1/2X3/8N
1/2"NPT X 3/8"NPT CLOSE
NIPPLE NYL

PL-HBE-SFPA
SHURFLO PORT ADAPTOR

PL-SLN-1/4D12M
1/4" DIVERSION VALVE 12v
(inside enclosure)

EL-SSR-150
PRESSURE SENSOR 0-150

PL-MTE-1/2X5/8P
1/2"NPT X 5/8" TUBE ELL
FITTING

PL-MTE-1/4X1/4P
1/4"NPT X 1/4" TUBE
FITTING ELL NYL

PL-MTE-1/2X1/2P
1/2"NPT X 1/2" TUBE
FITTING ELL NYL

EL-MPC-RMCD
MPC REMOTE CONTROL
(LCD)

PL-MTE-3/4X5/8P
3/4"NPT X 5/8" TUBE FITT.
ELL.

FT-FTH-10L3PCS
10" LOW PRESS. FILTER
HOUSING 3 PCS

PL-MTE-1/4X1/4P
1/4"NPT X 1/4" TUBE FITT-
ING ELL NYL



NEWPORT-400 MK II

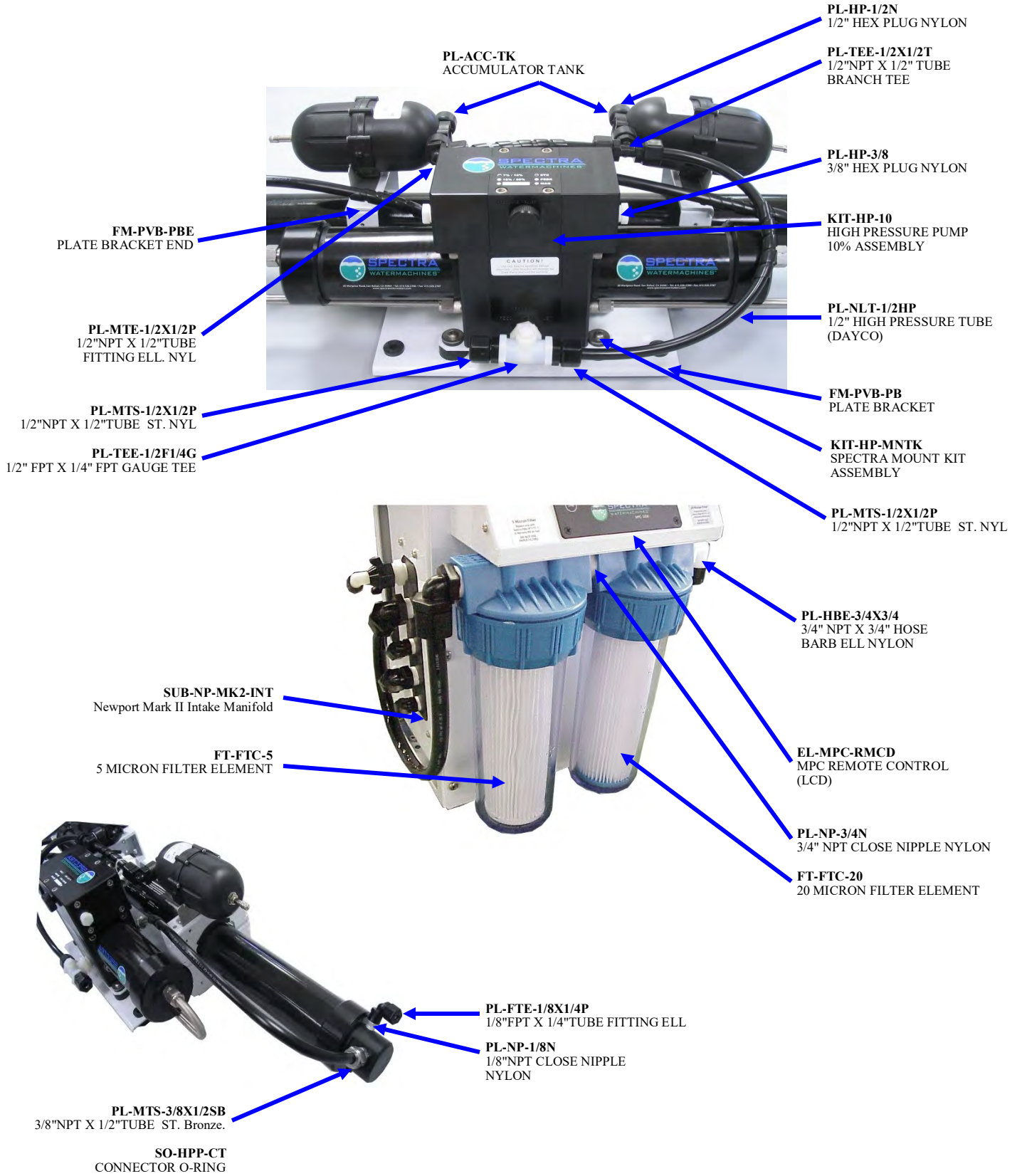

NEWPORT-400 MK II

KIT-NP-MK2-BPM1
NEWPORT MK2 SERVICE AND
BOOST PUMP MODULE

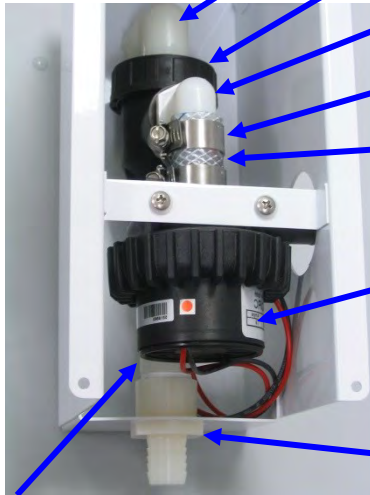

- PL-MFF-3/4X3/4**
3/4"MPT X 3/4"FPT ELBOW FITT.
NYLON
- PL-VLV-3W3/4**
3/4" 3-WAY VALVE
- PL-HBE-3/4X3/4**
3/4" NPT X 3/4" HOSE BARB ELL NYLON
- PL-CLP-10SS**
#10 HOSE CLAMP
- PL-HS-3/4VN**
3/4" VINYL HOSE
- EL-FP-BPLDC824**
300-1000 BOOSTER PUMP DC 8-24V
- PL-FHB-3/4X3/4**
3/4"FPT X 3/4 HOSE BARB ST. NYLON

PL-NP-3/4X5
3/4"NPT X 4.5" NIPPLE POLY

PL-SLN-1/4O12VB
1/4"1-WAY SOLENOID
VALVE 12V W/O VB

EL-SSR-ABS
ABSOLUTE PRESSURE SENSOR

PL-MTS-1/2X5/8P
1/2"NPT X 5/8" TUBE
FITTING ST

EL-SSR-IFM
INLINE FLOW SENSOR

PL-MTS-1/2X1/2P
1/2"NPT X 1/2" TUBE
FITTING ST. NYL

SUB-NP-MK2-INT
NEWPORT MK-II INTAKE
MANIFOLD

EL-MPC-SP4
SALINITY PROBE

PL-MTE-3/8X1/2P
3/8"NPT X 1/2" TUBE
FITTING ELL NYL



EL-MTR-PWMA
PULSE SWITCHING MOD-
ULE ASSEMBLY

EL-MTR-1/2HP12
1/2HP MOTOR 12V 2000
RPM 48YC TEFC

OR
EL-MTR-1/2HP24
1/2HP MOTOR 24V,2000
RPM, 48YC TEFC

PL-FTE-3/8X3/8P
3/8"FPT X 3/8" TUBE FITT.
ELL.

PL-MTE-3/8X3/8J
3/8"NPT X 3/8" TUBE FITTING
ELL.NYL

PL-PMP-140MG
MAG. DRIVE VANE PUMP
140 GPH

PL-FTE-1/2X5/8P
1/2"FPT X 5/8" TUBE
ELFITTING

PL-NP-1/2X3/8N
1/2"NPT X 3/8"NPT CLOSE NIPPLE NYL

NEWPORT-400 MK II

EL-SWT-TSBHC
TOGGLE SWITCH BOOT SEAL

EL-SWT-TG-DPDT
TOGGLE SWITCH DP/DT

FM-MPC-MPCB
MPC BOX

EL-MPC-PCBDPAxx
MPC-5000 CIRCUIT BOARD

This control is compatible with all previous MPC systems.

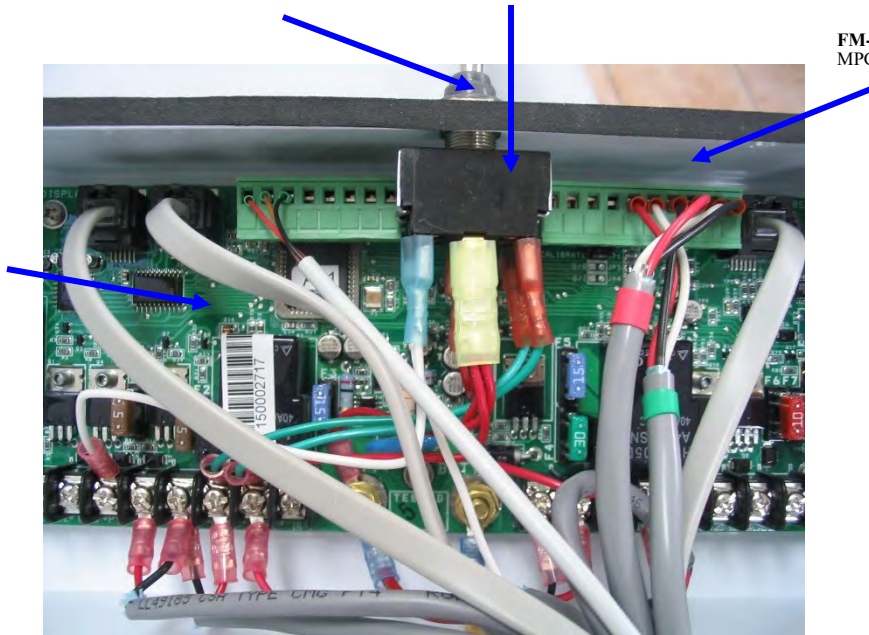

PL-HS-3/4VN
3/4" VINYL HOSE

PL-HS-3/4SH
3/4" REINFORCE SUCTION HOSE

PL-HS-5/8VN
5/8" VINYL HOSE



PL-NLT-1/2HP
1/2" HIGH PRESSURE
TUBE (DAYCO)

PL-HS-1/2VN
1/2" VINYL HOSE

NEWPORT-700/1000 MK II

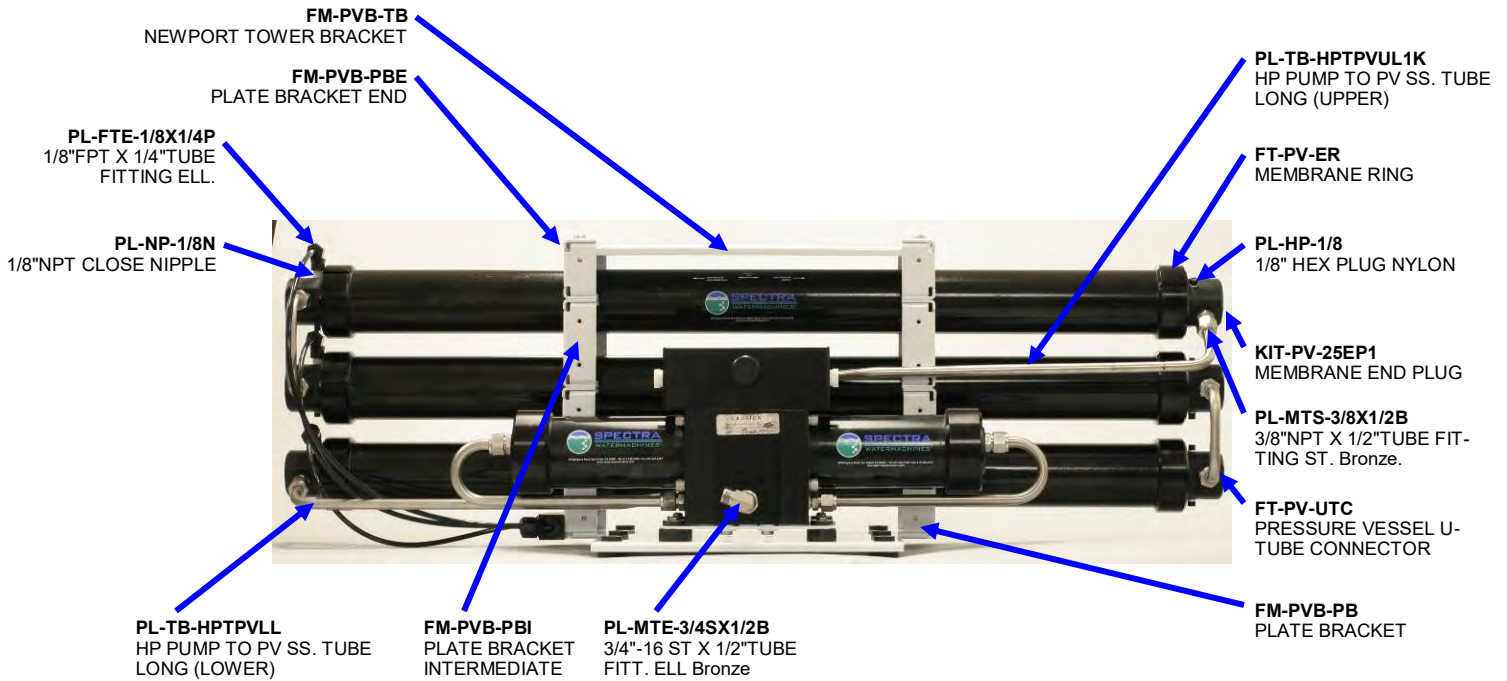

NEWPORT 700/1000 BOOST PUMP AND SERVICE VALVE ASSEMBLY

SUB-NP-MK2-1KB1 (12V)
SUB-NP-MK2-1KB (24V)

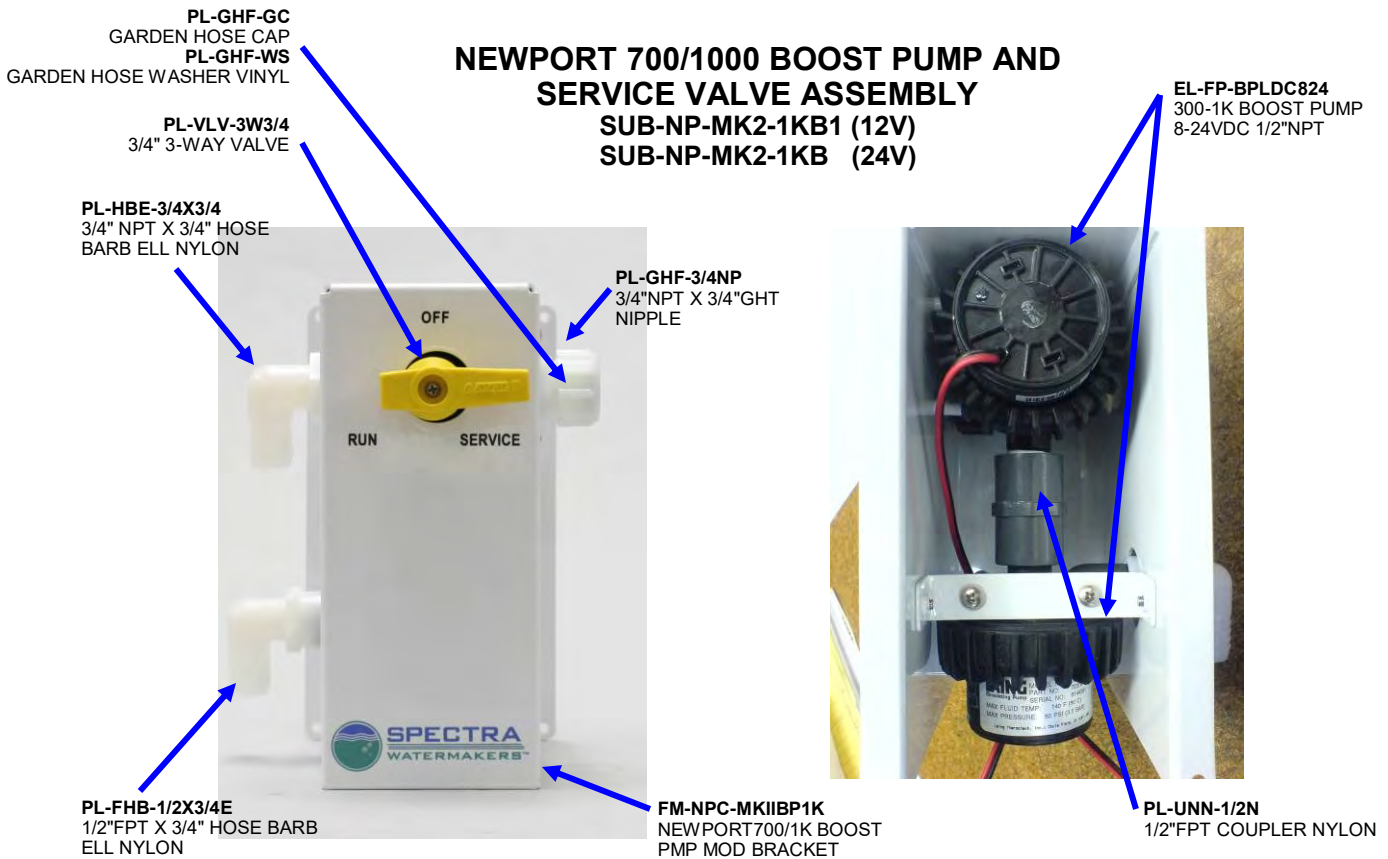

NEWPORT-700/1000 MK II

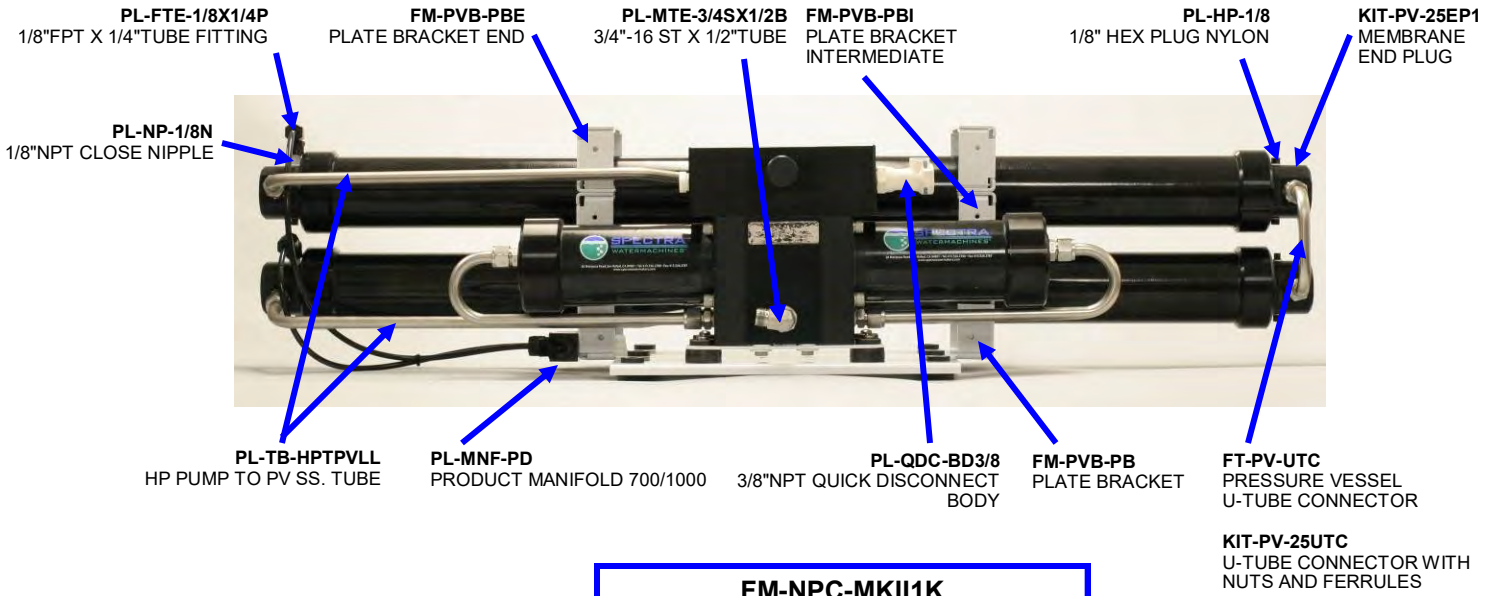

FM-NPC-MKII1K
NEWPORT 700/1000 MK-2
CHASSIS SHEETMETAL

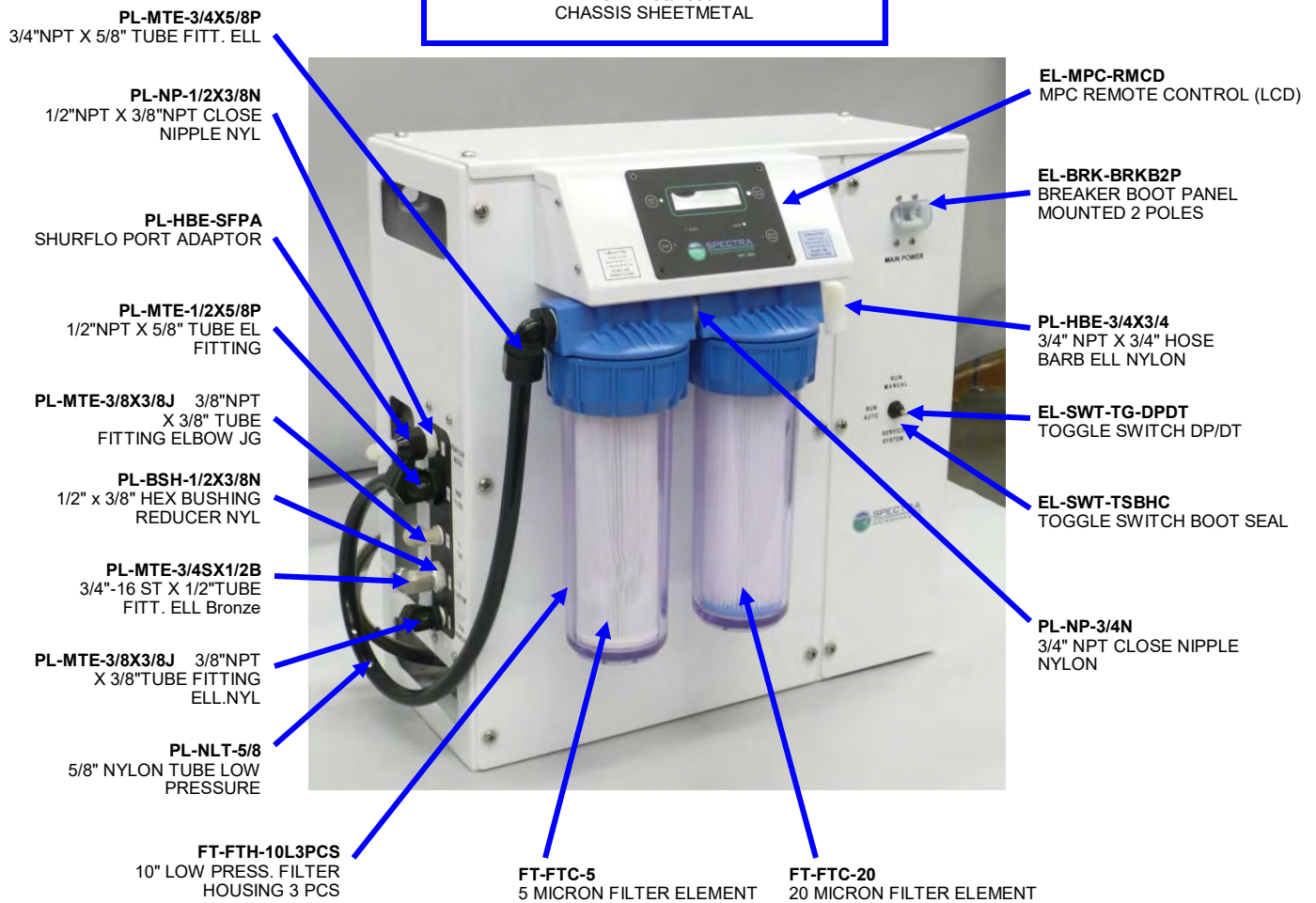

NEWPORT-700/1000 MK II

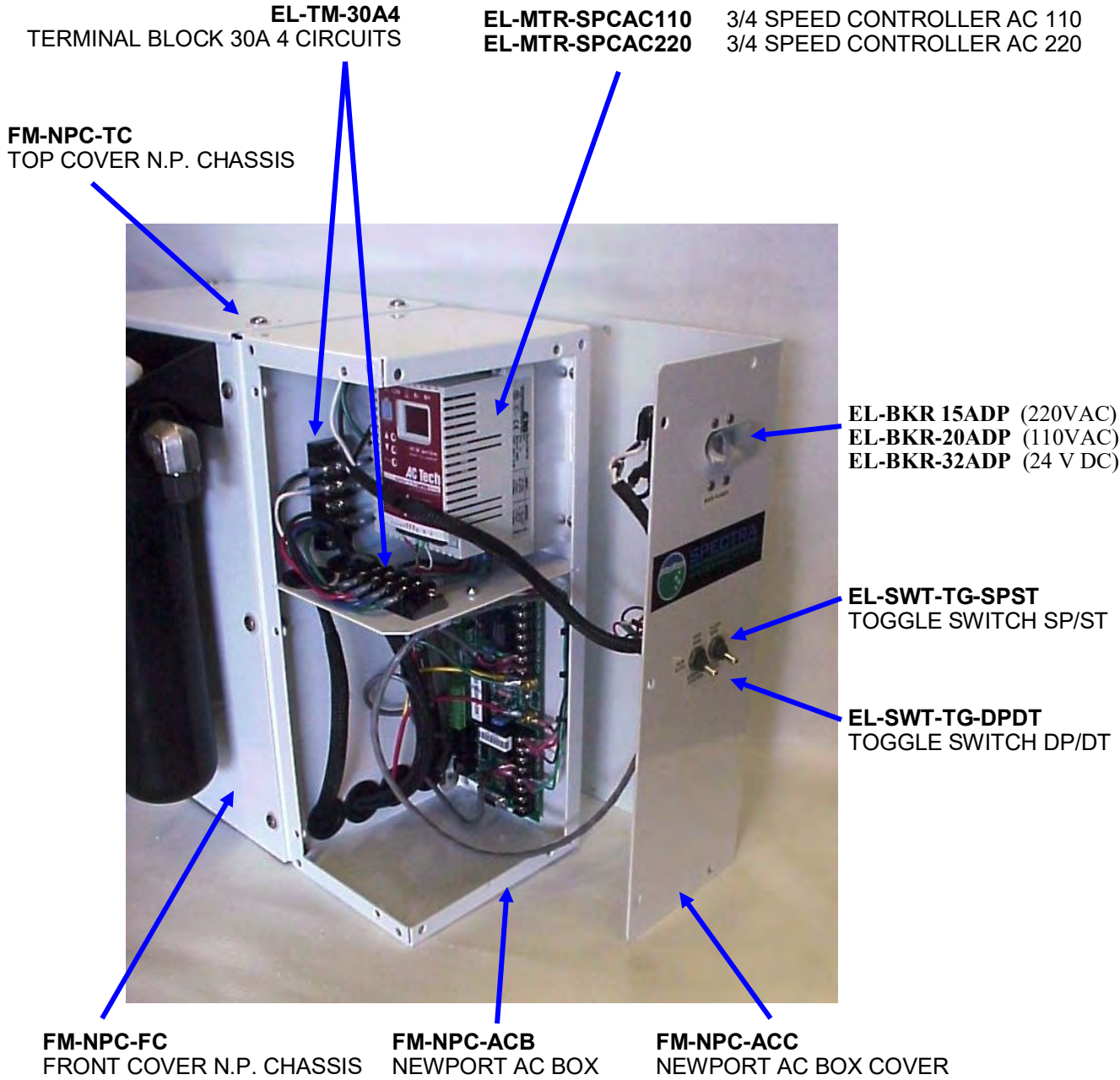

For more information on the AC Tech drives, please go to the technical section of our website and download the installation and operation manual for SCL and SCM series drives.

NEWPORT-700/1000 MK II

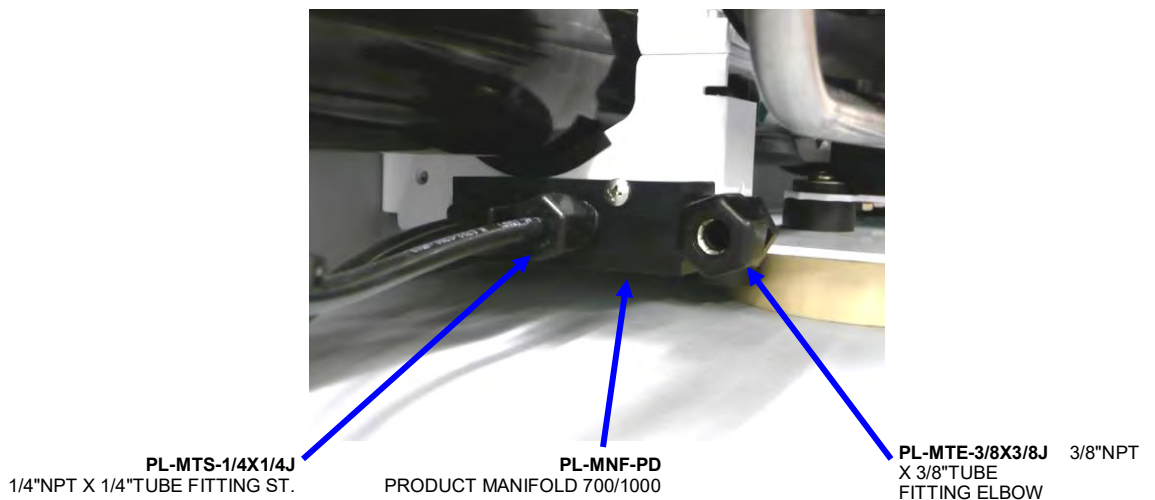
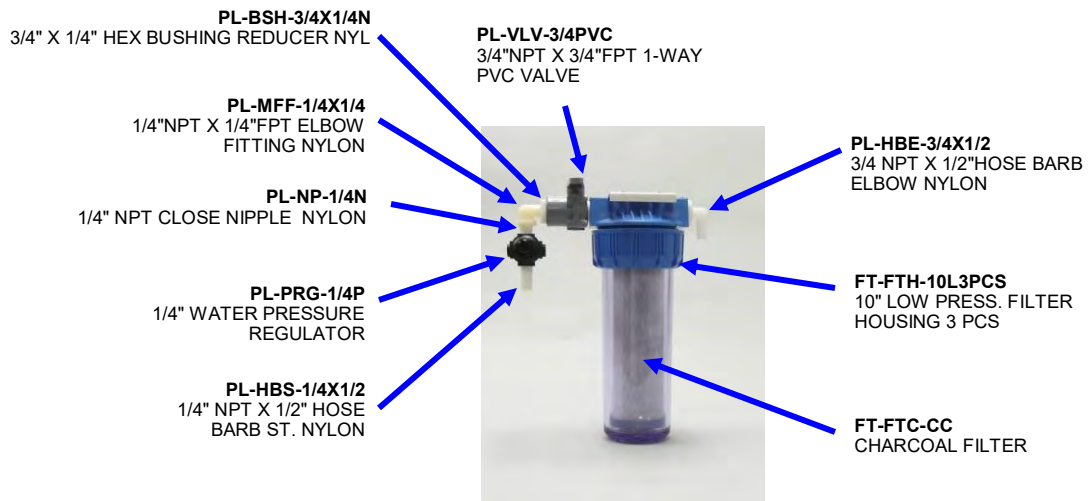
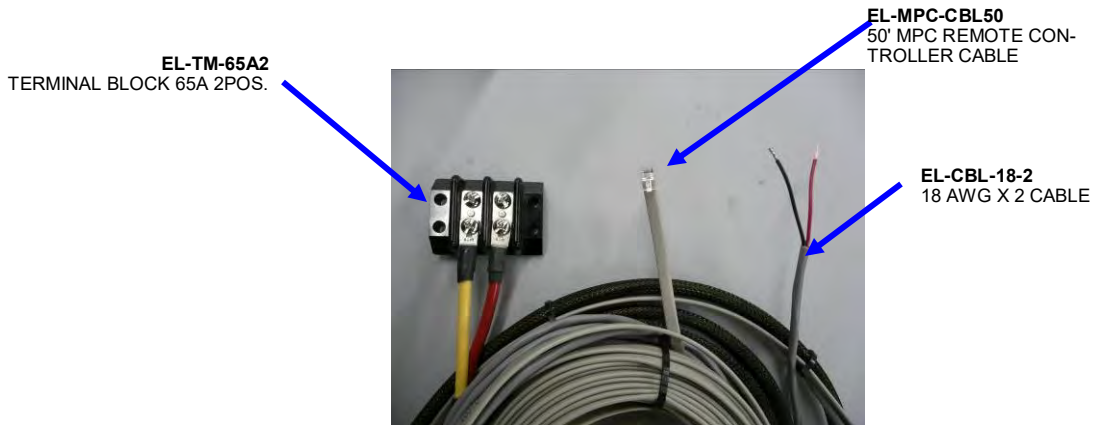

NEWPORT-700/1000 MK II

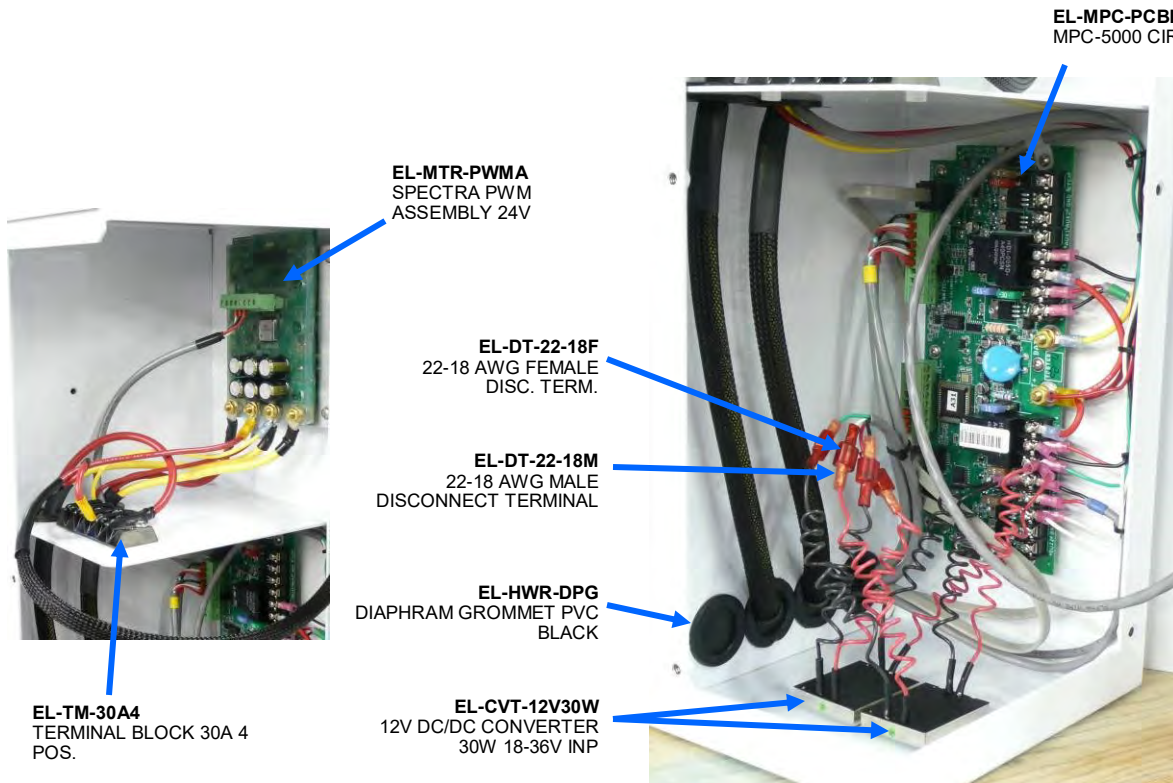
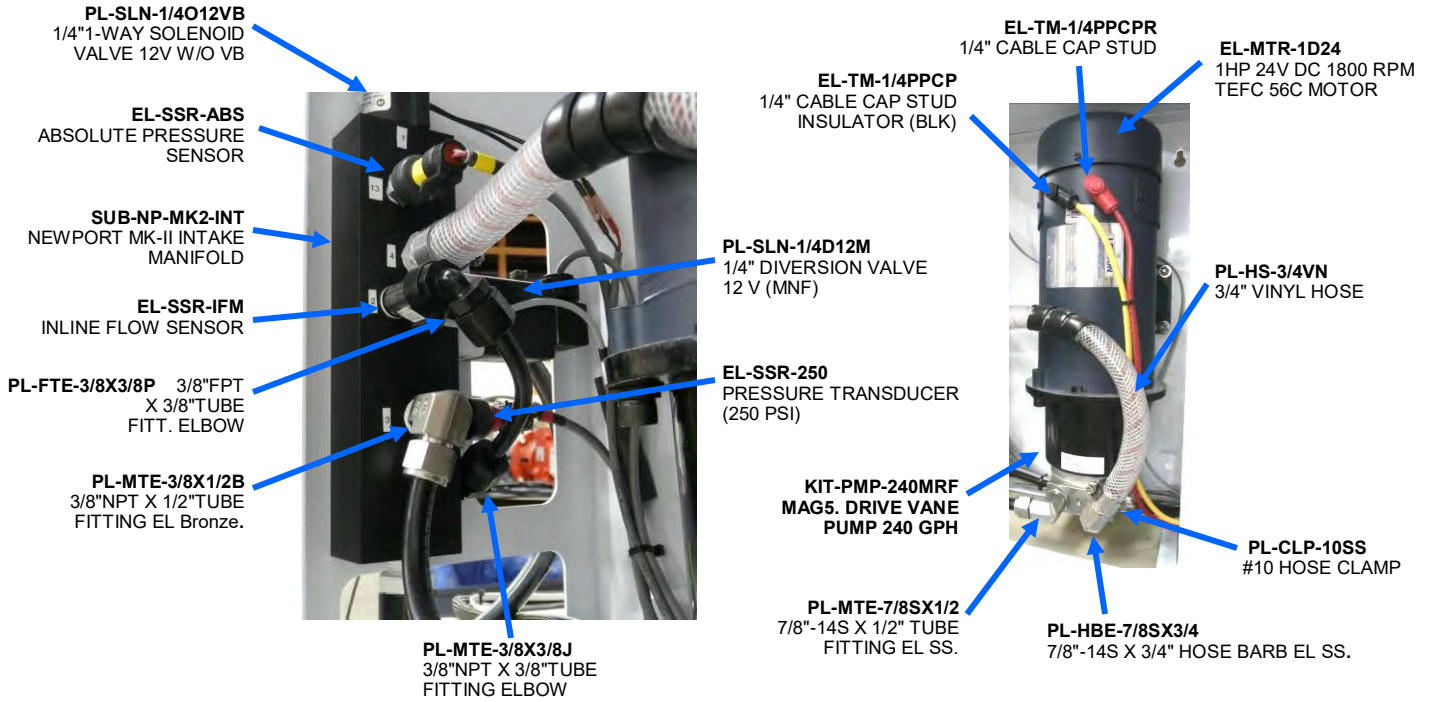

NEWPORT-700/1000 MK II

For 110 AC
EL-MTR-SPCAC110
 3/4 MOTOR SPEED CONTROLLER AC 110
 For 220 AC
EL-MTR-SPCAC220
 3/4 MOTOR SPEED CONTROLLER AC 220

For 110AC & 24 DC
EL-BRK-30ADP
 AC/DC BREAKER DP TOGGLE 30A
 For 220AC
EL-BRK-15ADP AC/DC BREAKER
 DP TOGGLE 15A

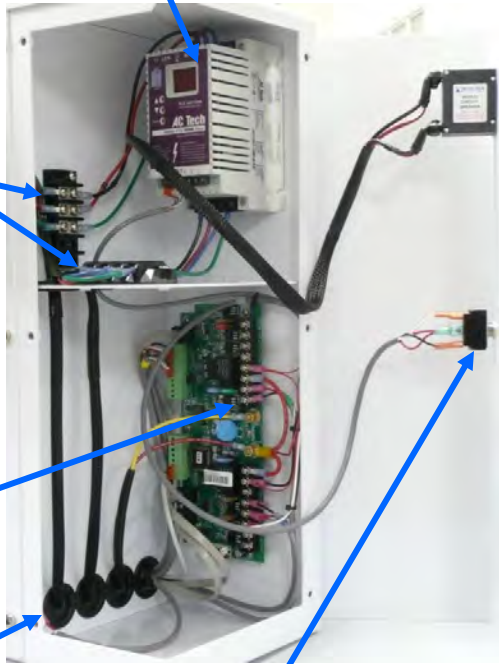

EL-TM-30A4
 TERMINAL BLOCK
 30A 4 POS.

EL-MCD-1/2NCG
 1/2" NYLON LIQUID-TIGHT
 CORD GRIP

EL-MTR-3/4AC220
 3/4 HP, 240 VAC, 3 PHASE, 56C
 MOTOR

EL-MPC-PCBDPAxx
 MPC-5000 CIRCUIT
 BOARD



PL-PMP-240MAG5
 MAG. DRIVE VANE PUMP
 240 GPH

PL-MTE-7/8SX1/2
 7/8"-14S X 1/2" TUBE FITTING EL SS.

PL-HBE-7/8SX3/4
 7/8"-14S X 3/4" HOSE BARB
 EL SS.

EL-HWR-DPG
 DIAPHRAM GROMMET
 PVC BLACK

EL-SWT-TG-DPDT
 TOGGLE SWITCH DP/DT



EL-TM-30A3
 TERMINAL BLOCK 30A 3 CIRCUIT

EL-TM-30A2
 TERMINAL BLOCK 30A 2 POS.

EL-MPC-CBL50
 50' MPC REMOTE CONTROLLER CABLE

EL-BC-22-18HS
 22-18 AWG BUTT CONN. W/ HEAT SHRINK

EL-CBL-18-2
 18 AWG X 2 CABLE

CATALINA PART NUMBERS

EL-SSR-150
PRESSURE TRANSDUCER
(150 PSI)

EL-SSR-PSH
PRESSURE SENSOR
CABLE

PL-MFF-1/4X1/4
1/4"MPT X 1/4" FPT ELBOW
NYLON

PL-HBE-3/4X5/8
3/4"MALE NPTX5/8"HOSE BARB
ELBOW NYLON

FT-FHB-10HD
HIGH PRESS. HOUSING
BRACKET DUPLEX

FT-FTH-10H
HIGH PRESSURE FILTER HOUSING

PL-MTE-3/4X1/2P
3/4"MPT X 1/2" BARB
ELBOW

PL-NP-3/4N
3/4" CLOSE NIPPLE NYLON



PL-SLN-1/4D12 ,24
1/4" DIVERSION VALVE 12,24V

PL-MTE-3/8X1/4J
3/8" MPT X 1/4" TUBE FITT.
ELBOW

PL-CKV-1/4M-F
1/4" PLASTIC CK VALVE (M-F)

SUB-NP-DVM
DIVERSION VALVE
MANIFOLD

PL-MTS-1/4X3/8J
1/4"MPT X 3/8" TUBE FITT. ST.

EL-SSR-IFM
INLINE FLOW METER

PL-MTS-1/4X1/4J
1/4"NPT X 1/4" TUBE FITT ST.

Salinity Probe
EL-MPC-SP (up to A31)
EL-MPC-SP4 (from A-34)

REDUCING COUPLING
PL-UNN-3/8X1/4N

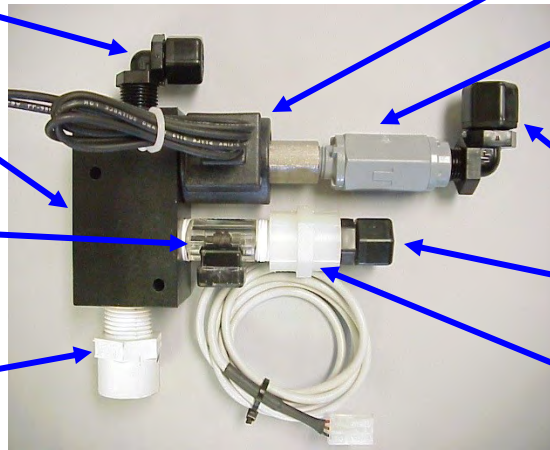

PL-NLT-3/8LP NYLON TUBE

PL-ACC-TK
ACCUMULATOR

EL-SWT-VC VACUUM SWITCH

FM-MPC-MPCB
MPC BOX

PL-MTE-1/4X3/8J TUBE ELBOW

FM-CT-PM
PUMP MODULE FRAME

EL-MTR-1/6D12 12 Volt Motor
EL-MTR-1/6D24 24 Volt Motor

PL-HBS-1/2X3/4
1/2"NPT X 3/4" HOSE BARB
NYLON

PL-PMP-100MAG
Feed Pump Head

PL-TEE-1/2FN
1/2NPT NYLON TEE

PL-HBS-3/8X5/8
3/8"MPT X 5/8" HOSE BARB
STRAIGHT

PL-NP-1/2X3/8N
1/2X3/8 NPT NYLON NIPPLE

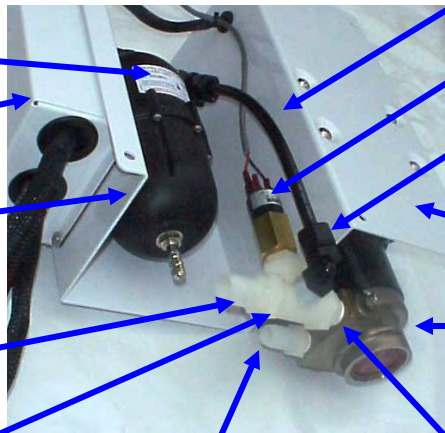

CATALINA Parts



MPC CONTROL PANEL (LCD) EL-MPC-RMCD

FLOW METER PL-FMT-20

1/8NPT X 1/4 TUBE EL PL-MTE-1/8X1/4P

REMOTE SWITCH ASSEMBLY SUB-CT-SAM

1/4" FPT X 1/4 TUBE EL PL-FTE-1/4X1/4P

COMPLETE PANEL ASSY KIT-CT-CTPAM

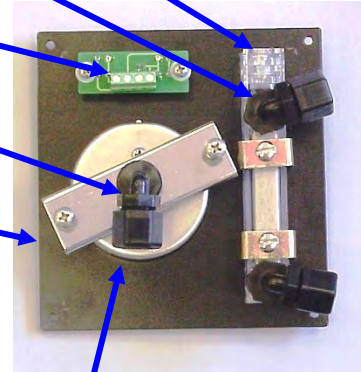

PRESSURE GAUGE PL-PSG-LP2.5

1/4 INCH LOW PRESS TUBE PL-NLT-1/4LP

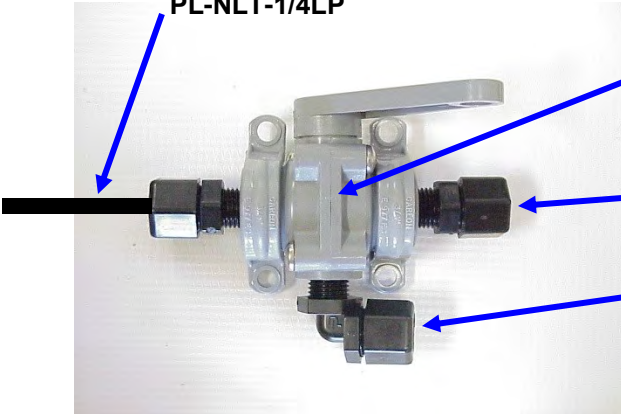

PRODUCT WATER SAMPLING VALVE PL-VLV-3W1/4

1/4 TUBE X 1/4 MPT STRAIGHT FITTING PL-MTS-1/4X1/4J

1/4 TUBE X 1/4 NPT EL PL-MTE-1/4X1/4P

3/4"-16 X 1/2" TUBE FITT. ELBOW (BACK SIDE) PL-MTE-3/4SX1/2B

HI REJECTION MEMBRANE 40" FT-MB-40F (INSIDE HOUSING)

BRACKET PLATE END FM-PB-PBE



PL-NLT-1/2HP 1/2" HIGH PRESSURE TUBE (DAYCO)

PL-HBE-3/8X5/8 NYLON HOSE BARB ELBOW

FM-PVB-PB BRACKET PLATE

RUBBER MOUNT HD-RBP-RM

CATALINA Parts

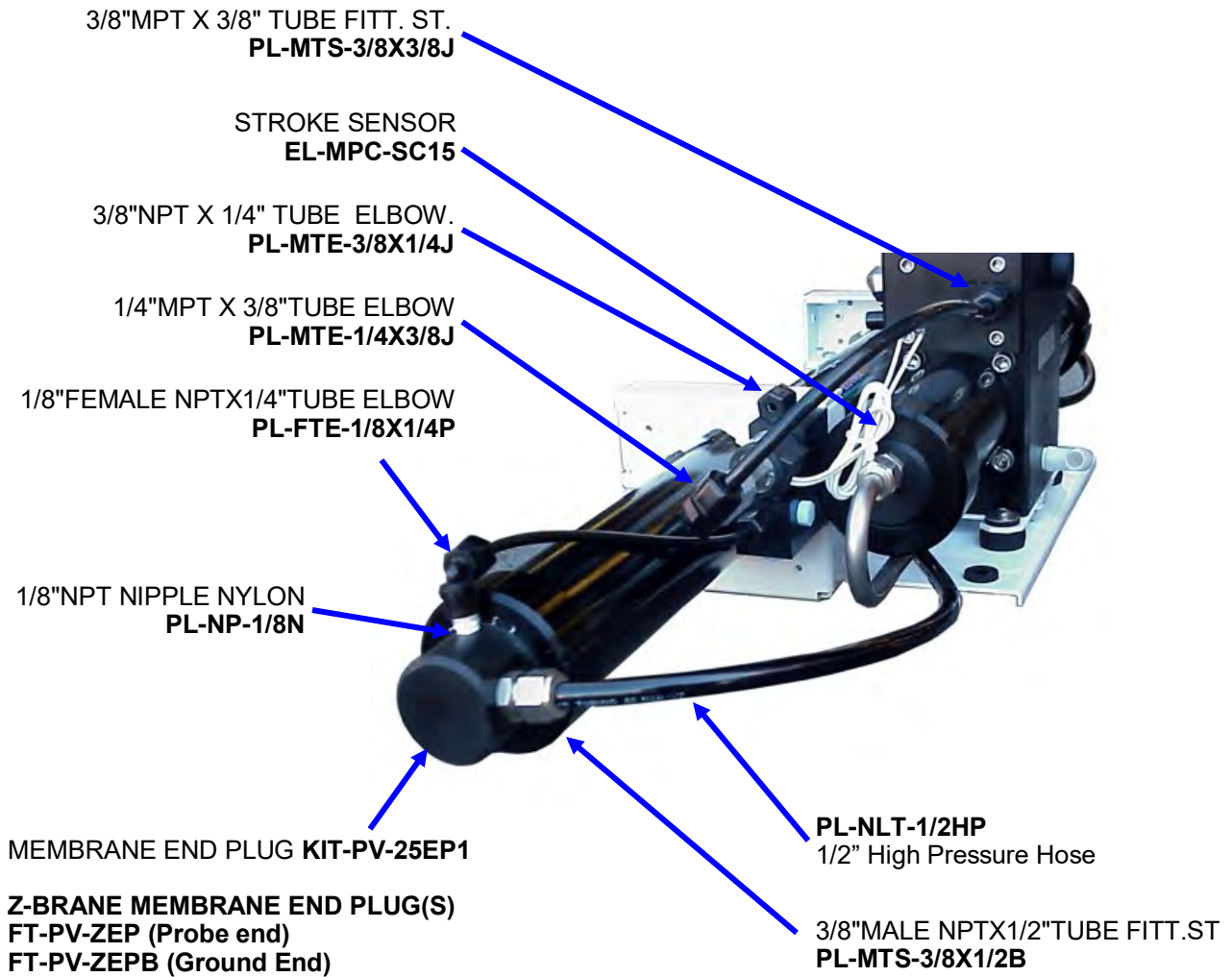

CATALINA Parts

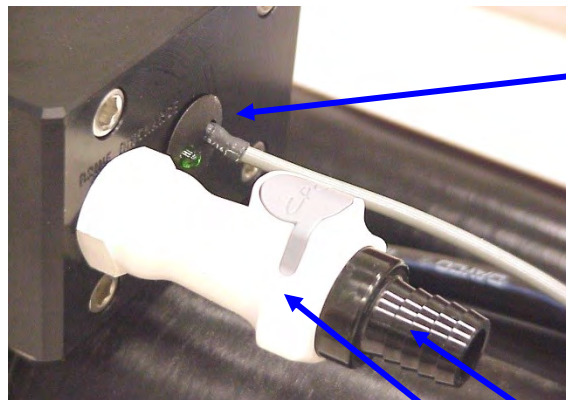
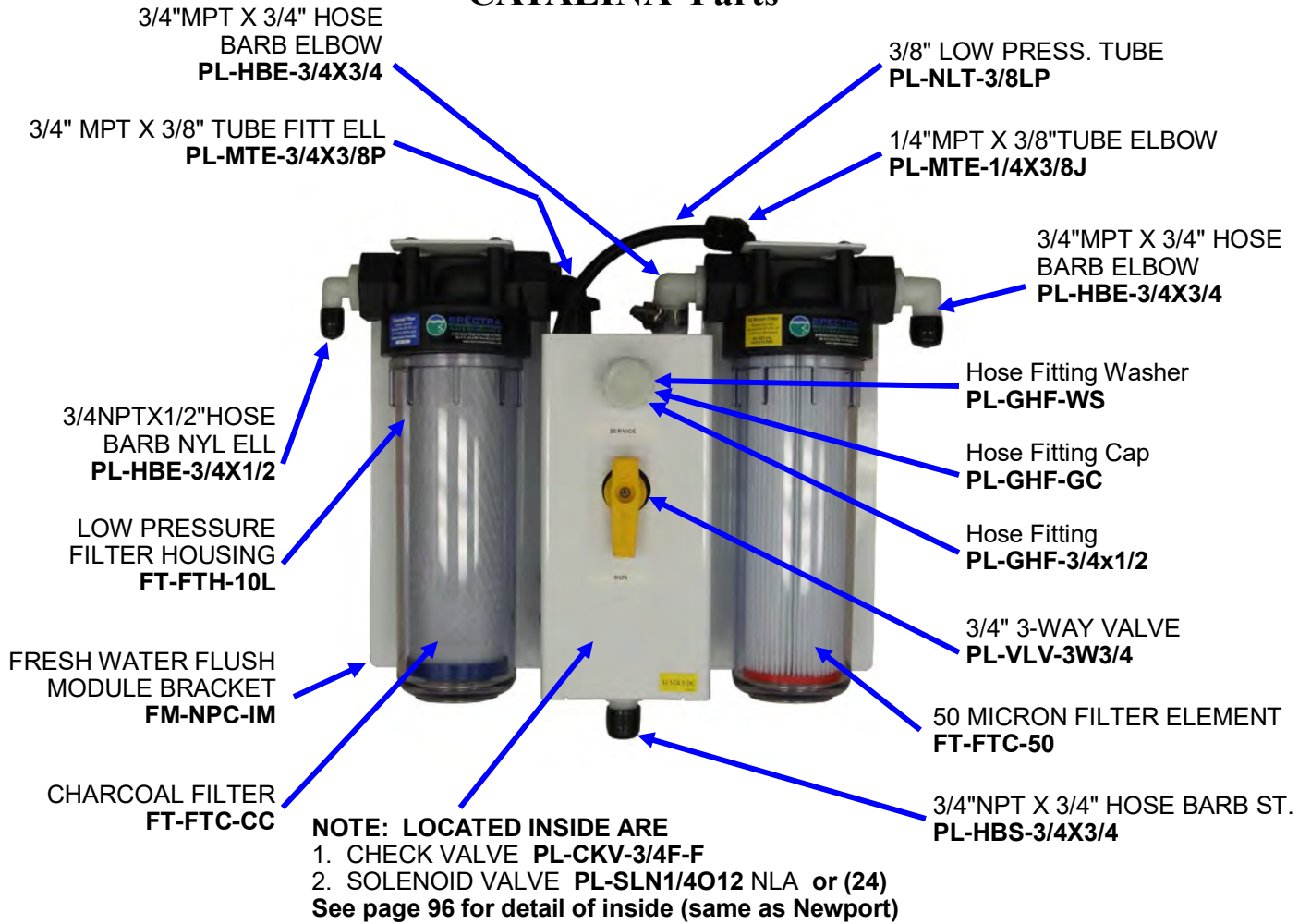

EL-MPC-SC15
Stroke sensor

5/8" QUICK DISCNT. FITT. HOSE BAR
PL-QDC-HB5/8

3/8" NPT QUICK DISCNT. COUP. BOD
PL-QDC-BD3/8

CATALINA DELUXE Parts

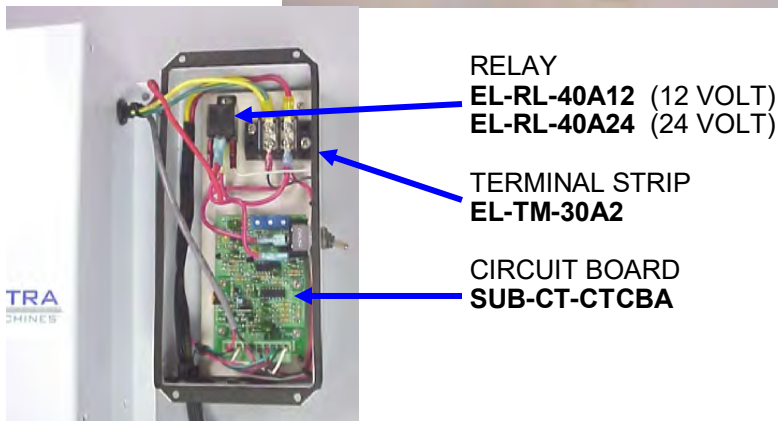
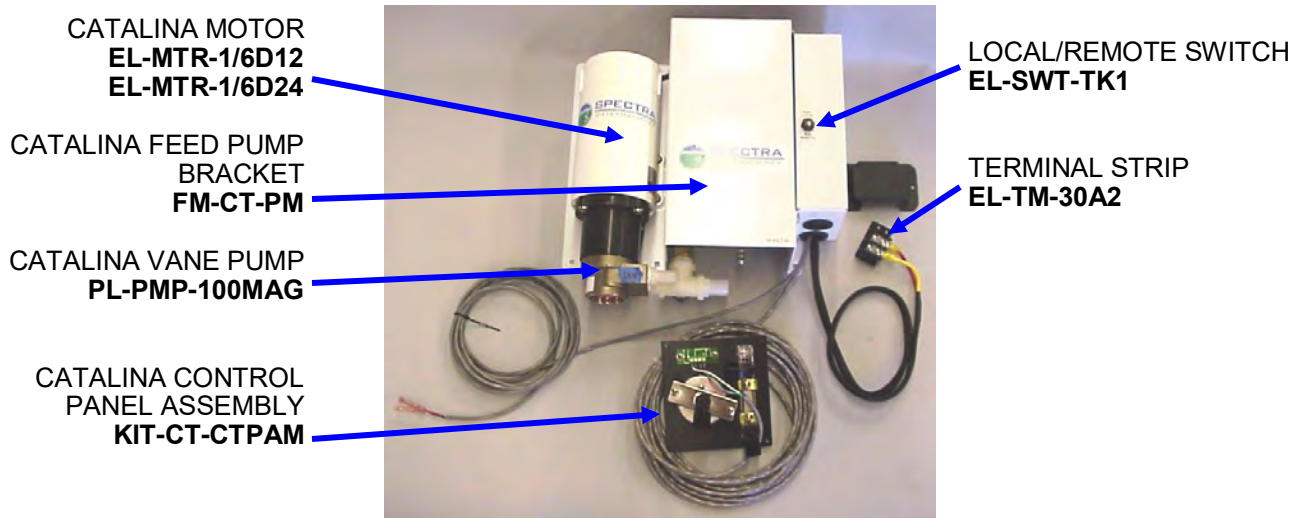
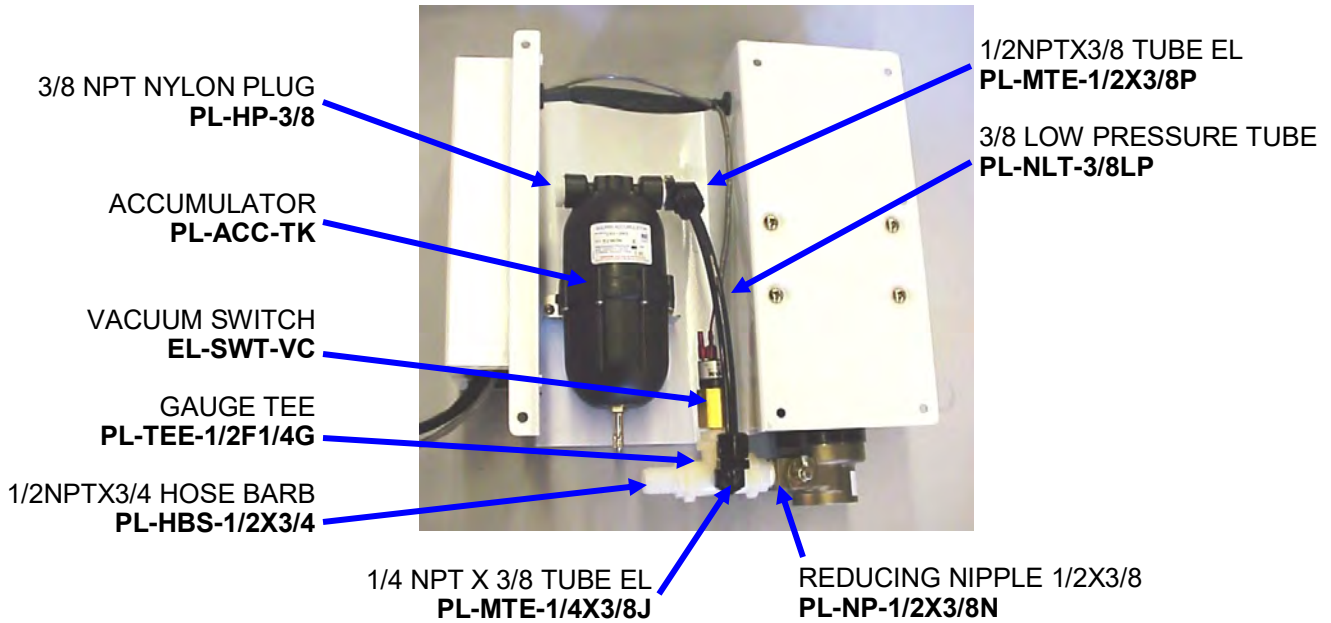

NEWPORT 700/1000 (MK1) Pump Module Parts (cont)

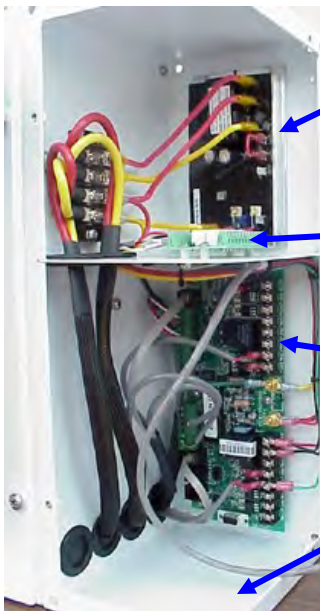
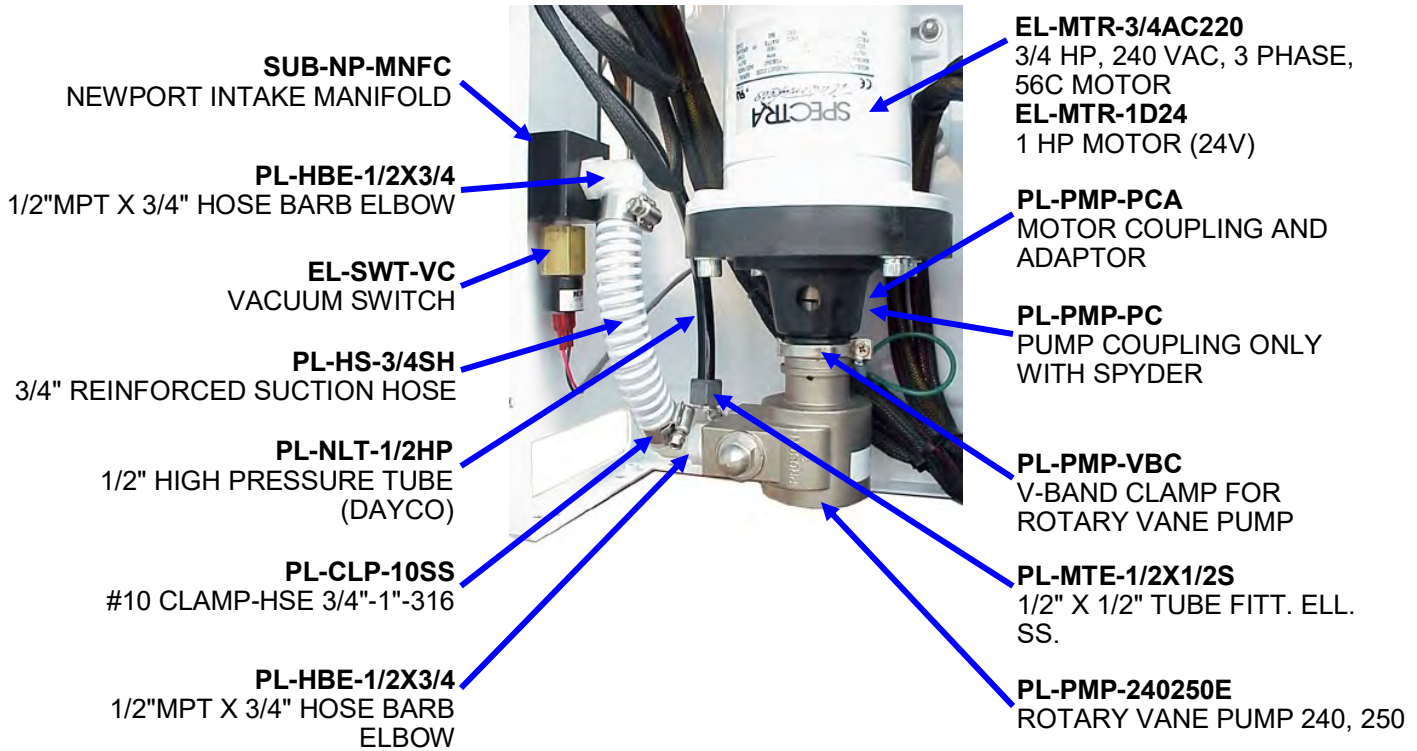

EL-MTR-SPCDC
3/4HP SPEED CONTROLLER 24V
EL-MTR-SPCDC12
3/4 HP SPEED CONTROLLER 12V

SUB-NP-12VRLBA 12V RELAY MODULE
SUB-NP-24VRLBA 24V RELAY MODULE
(located under shelf on some units)

EL-MPC-PCBDPaxx
CONTROL MODULE PCB

FM-NPC-ACB
NEWPORT AC BOX

NEWPORT Parts

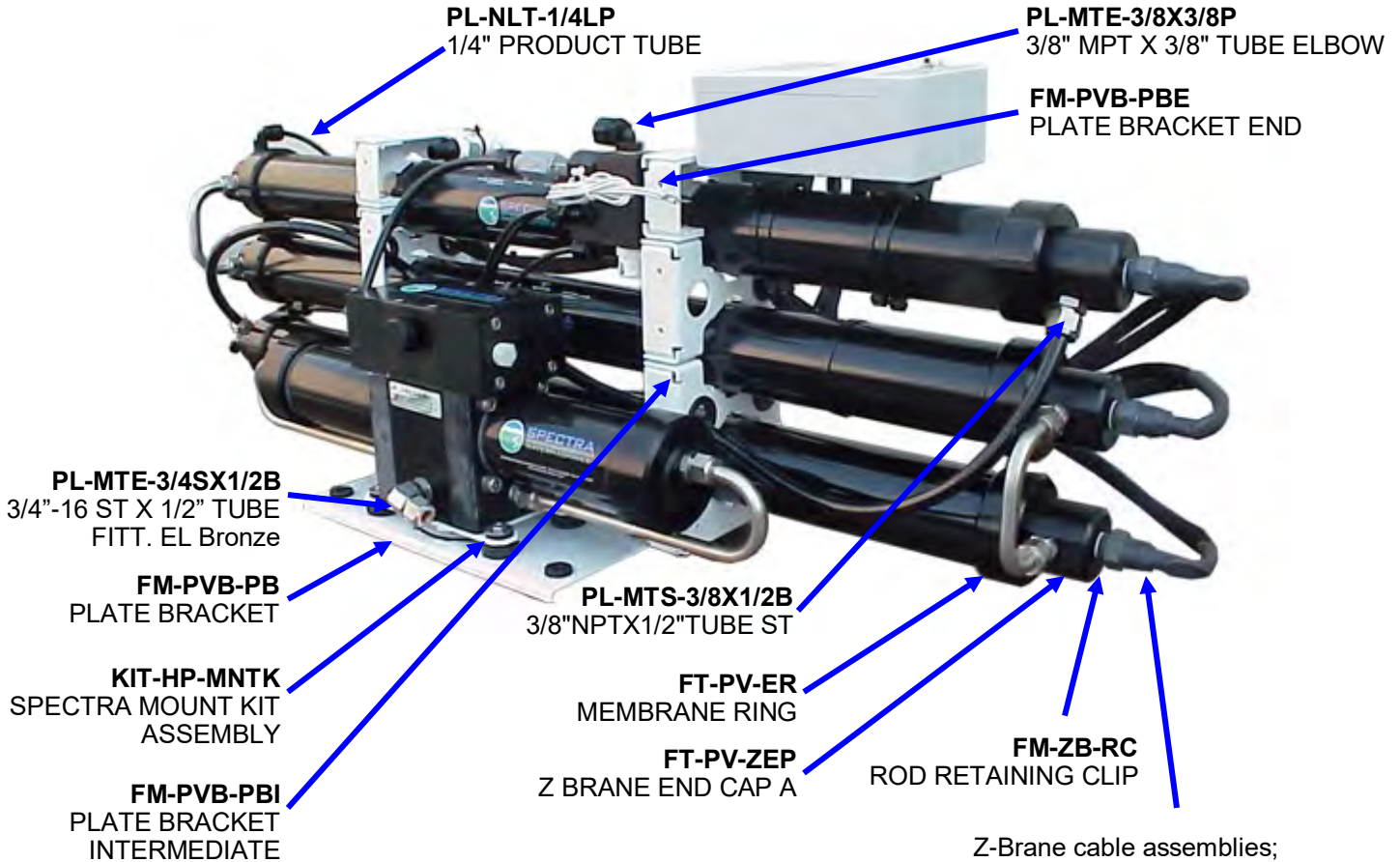

Z-Brane cable assemblies;
 Three Membrane Systems **SUB-ZG-ZB3RA**
 Two Membrane Systems **SUB-ZG-ZB2RA**
 Single Membrane Systems **SUB-ZG-ZB1RA**

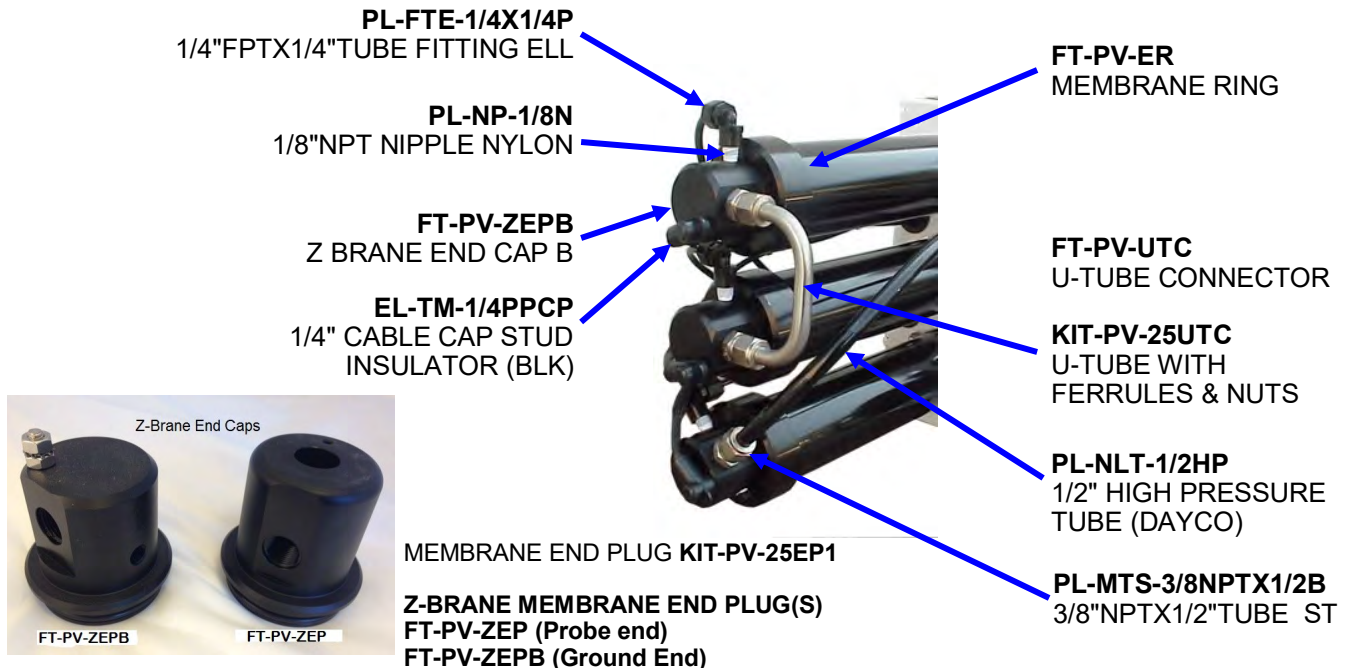

MEMBRANE END PLUG **KIT-PV-25EP1**
Z-BRANE MEMBRANE END PLUG(S)
FT-PV-ZEP (Probe end)
FT-PV-ZEPB (Ground End)

NEWPORT Parts

PL-CKV-1/4M-F
1/4" PLASTIC CK VALVE (M-F)

PL-MTS-1/4X3/8J
1/4"MPT X 3/8" TUBE ST.

PL-MTE-3/8X3/8J
3/8" NPT X 3/8" TUBE FITT. ELBOW

PL-MTS-1/4X1/4J
1/4" NPTX1/4" TUBE FITT. ST.

PL-SLN-1/4D12 (24)
1/4" DIVERSION VALVE 12V, 24V

PL-MTE-3/8X3/8J
3/8" NPT X 3/8" TUBE FITT. ELBOW

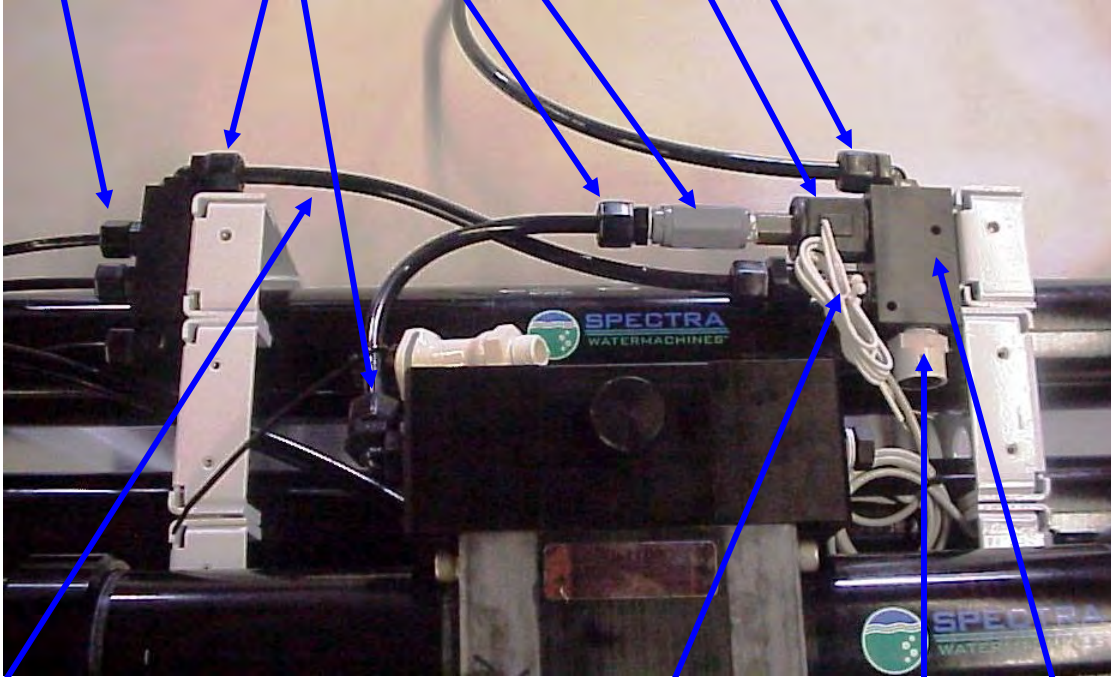

PL-NLT-3/8LP
3/8" LOW PRESS. TUBE

EL-SSR-IFM
INLINE (ROTO) FLOW METER

EL-MPC-SP
SALINITY PROBE

SUB-NP-DVM
DIVERSION VALVE MANIFOLD



MPC CONTROL PANEL (LCD)
EL-MPC-RMCD
MPC CONTROL PANEL (VFD)
EL-MPC-RMCFD

NEWPORT Parts

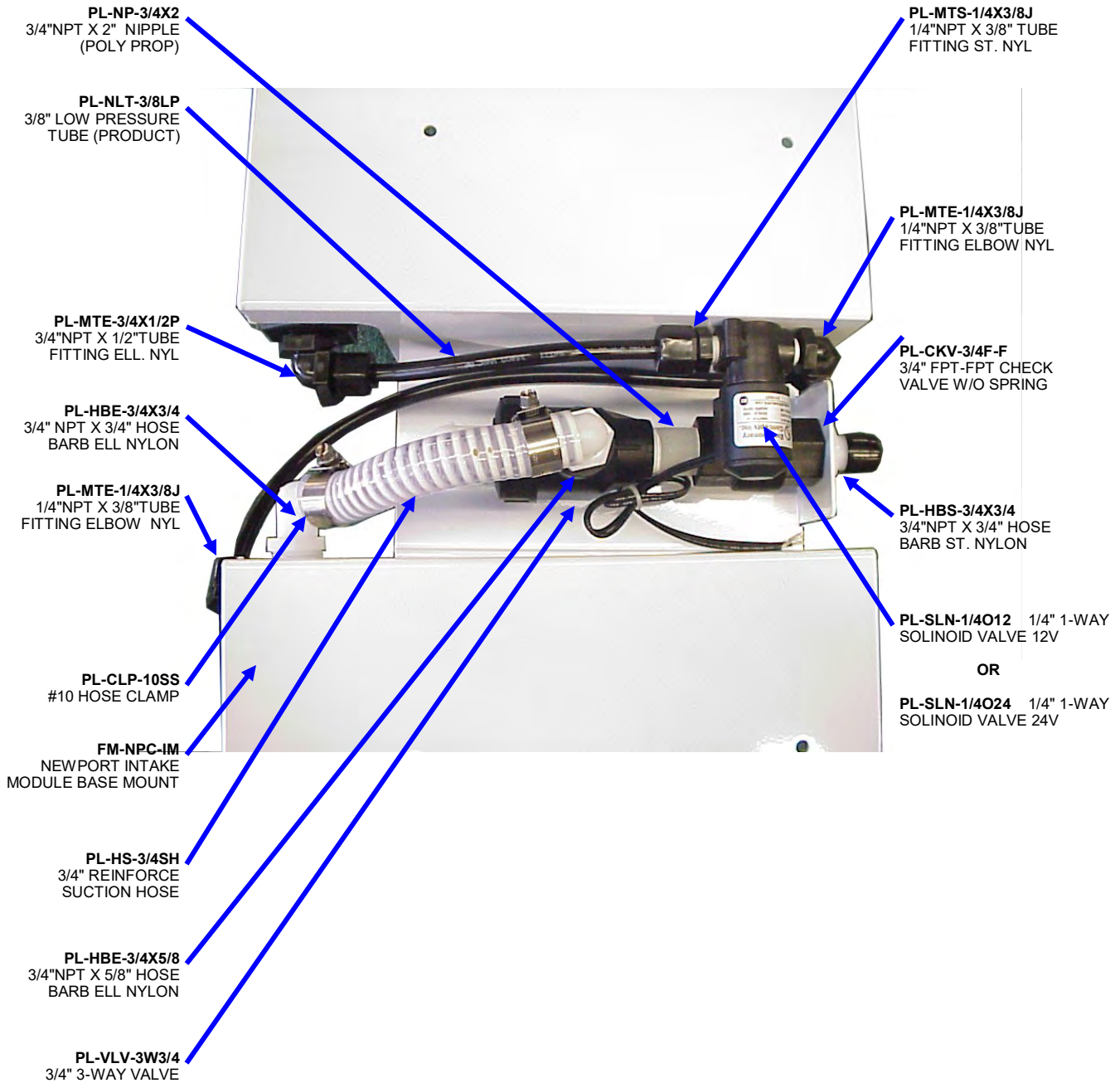

NEWPORT Parts

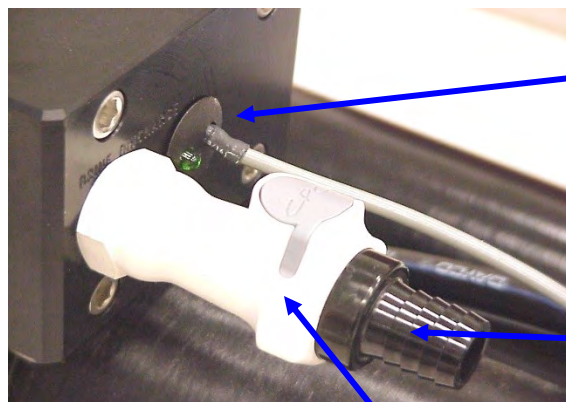
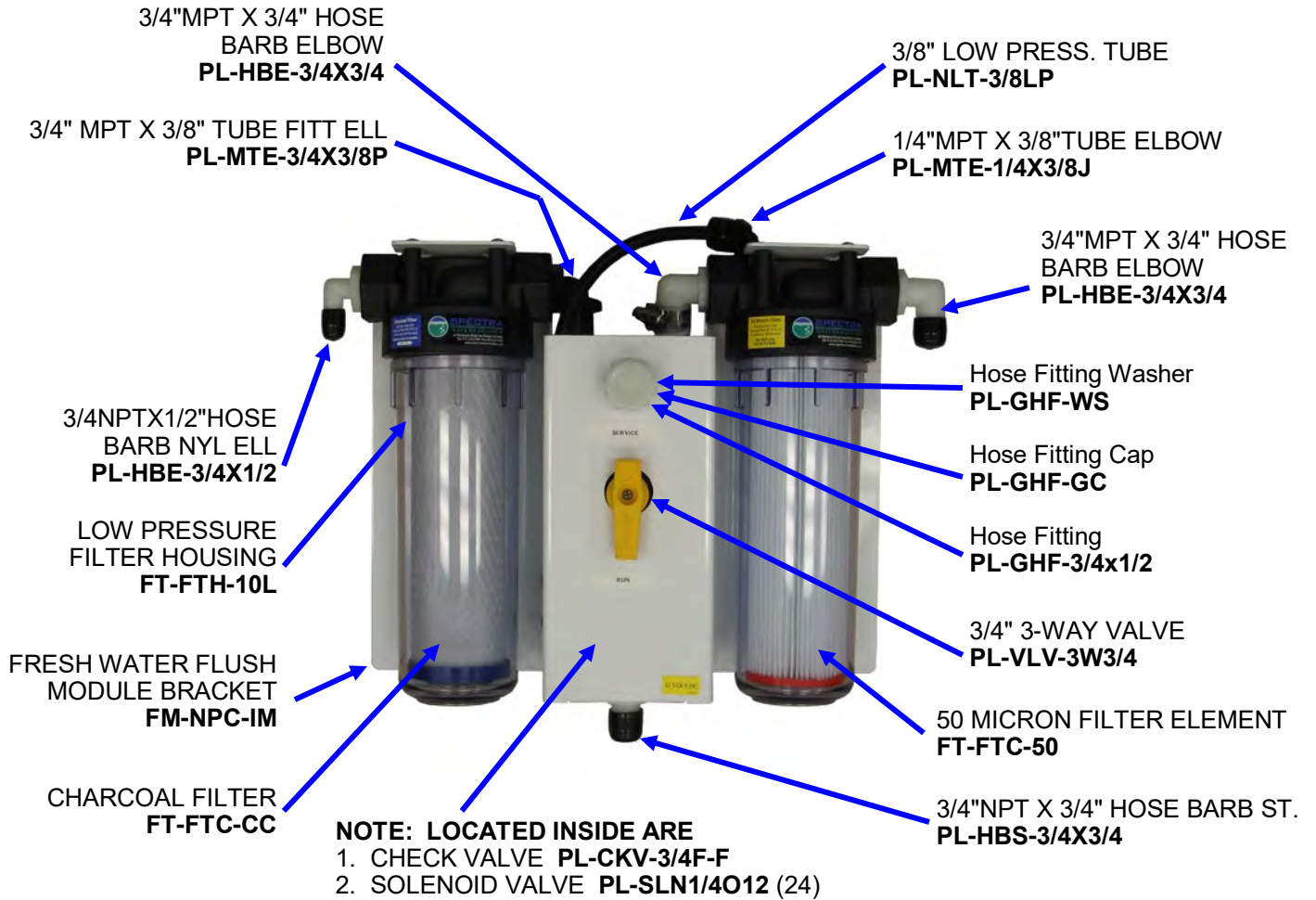

EL-MPC-SC15
Stroke sensor

5/8" QUICK DISCNT. FITT. HOSE BARB
PL-QDC-HB5/8

3/8" NPT QUICK DISCNT. COUP. BODY
PL-QDC-BD3/8

NEWPORT MAG Parts

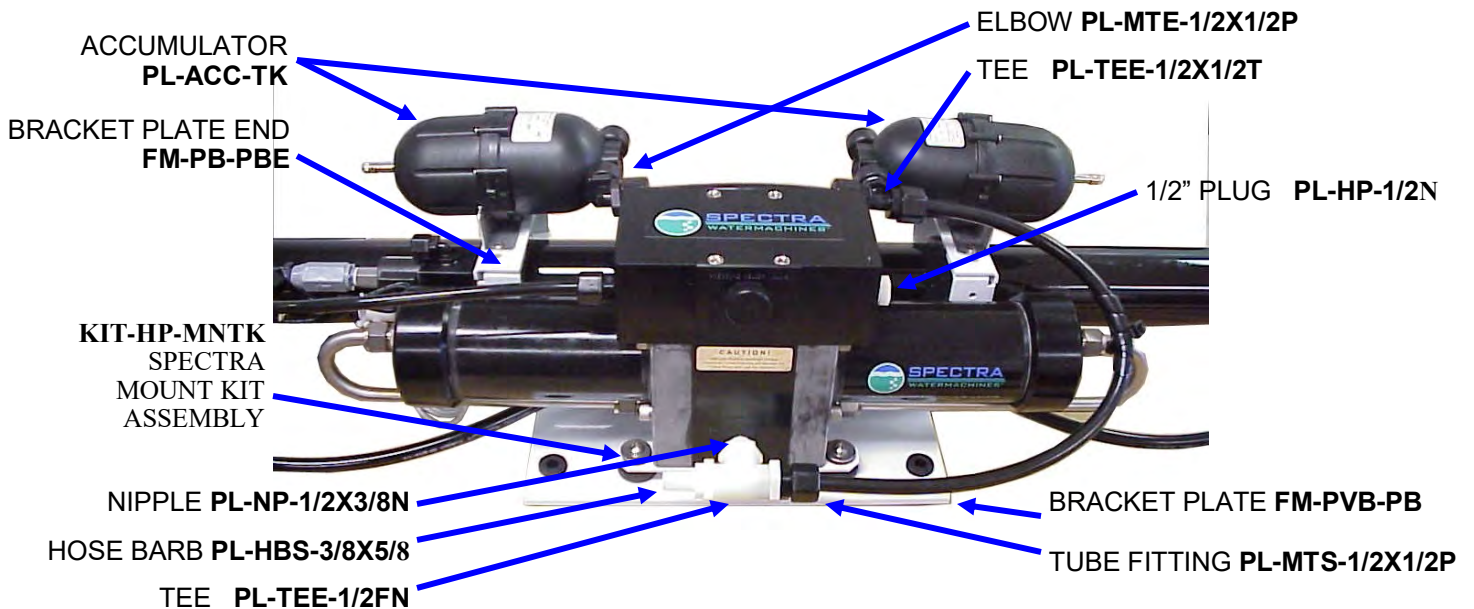
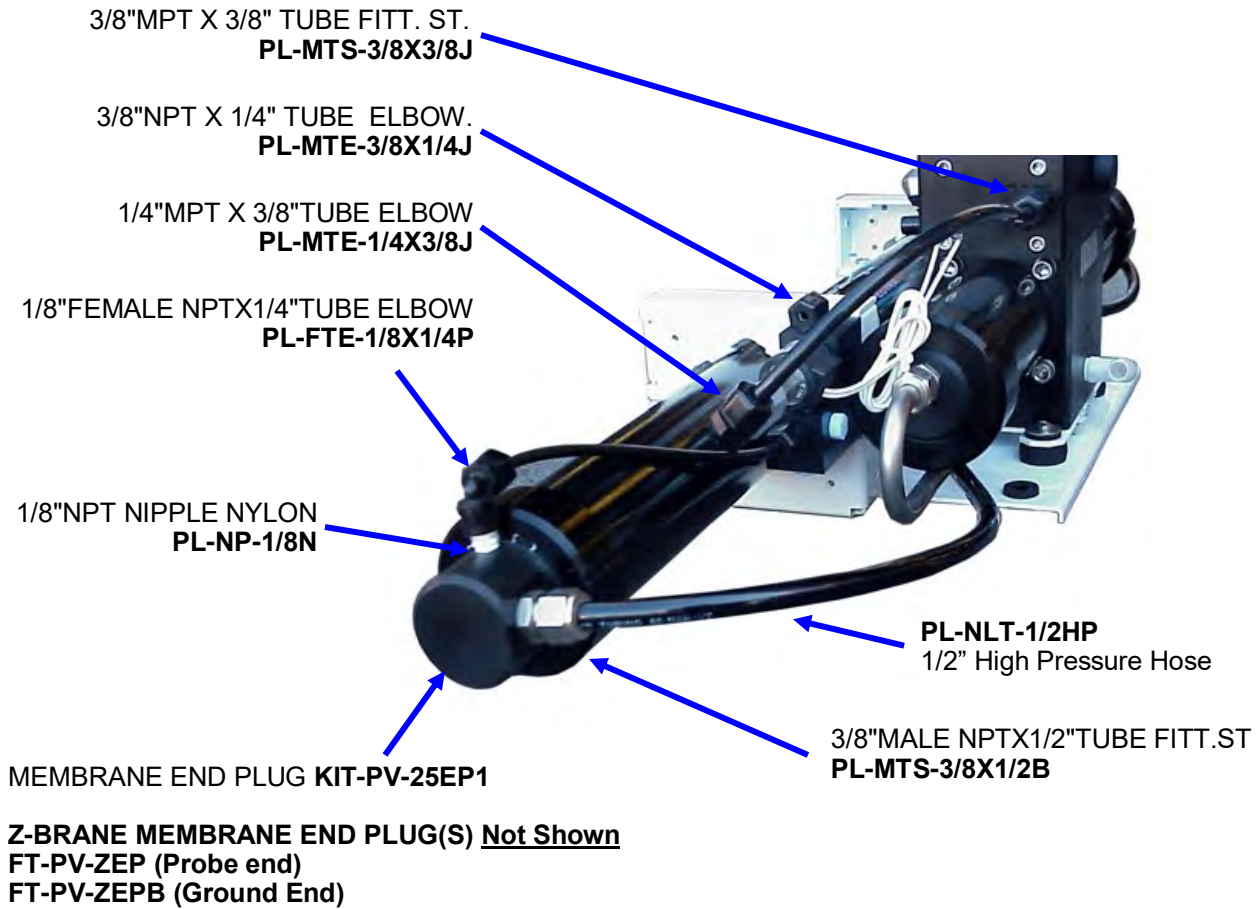

NEWPORT MAG Parts



MPC CONTROL PANEL (LCD)
EL-MPC-RMCD

RUBBER MOUNT
HD-RBP-RM

Z-BRANE END CAP ASSY WITH ROD
SUB-ZG-ZB

HI REJECTION MEMBRANE 40"
FT-MB-40F

Z-BRANE POWER SUPPLY
SUB-ZG-BSZBPS



1/2" HIGH PRESSURE TUBE (DAYCO)
PL-NLT-1/2HP

1/2" LOW PRESS. TUBE
PL-NLT-1/2LP

EL-SWT-TG-SPST
S,P,/S.T. (ON-OFF-ON) SWITCH
EL-SWT-TSBHC
TOGGLE SWITCH BOOT SEAL

FM-MPC-MPCB
MPC BOX

EL-SSR-PSH
PRESSURE SENSOR
CABLE

EL-SSR-150
PRESSURE TRANSDUCER
(150 PSI) INLET & OUTLET

PL-MTE-3/4X1/2P
3/4"MPT X 1/2" TUBE
ELBOW

PL-MFF-1/4X1/4
1/4"MPT X 1/4" FPT ELBOW NYLON

FT-FHB-10HD
HIGH PRESS. HOUSING
BRACKET DUPLEX

PL-HBE-3/4X5/8
3/4"MALE NPTX5/8"HOSE
BARB ELBOW NYL.

PL-CLP-8SS
#8 HOSE CLAMP

PL-NP-3/4N
3/4" CLOSE NIPPLE NYLON

FT-FTH-10H
HIGH PRESSURE
FILTER HOUSING

NEWPORT MAG Parts

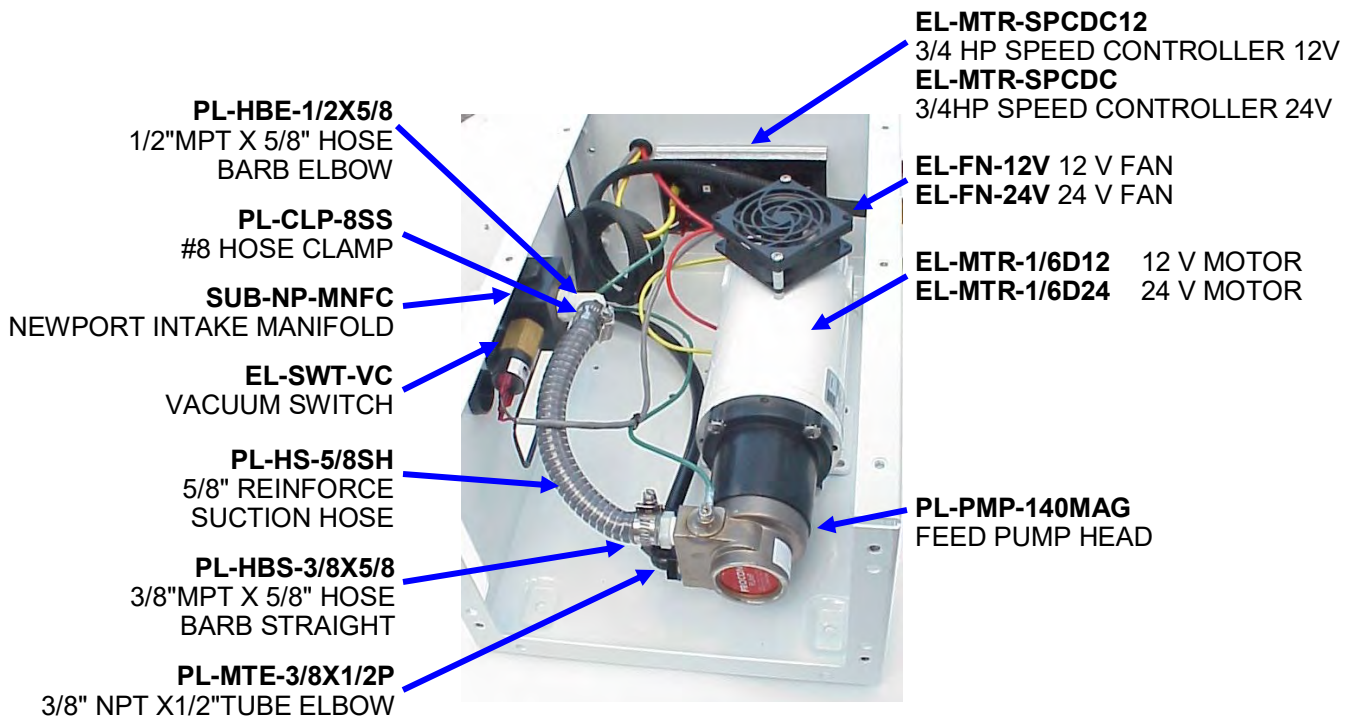
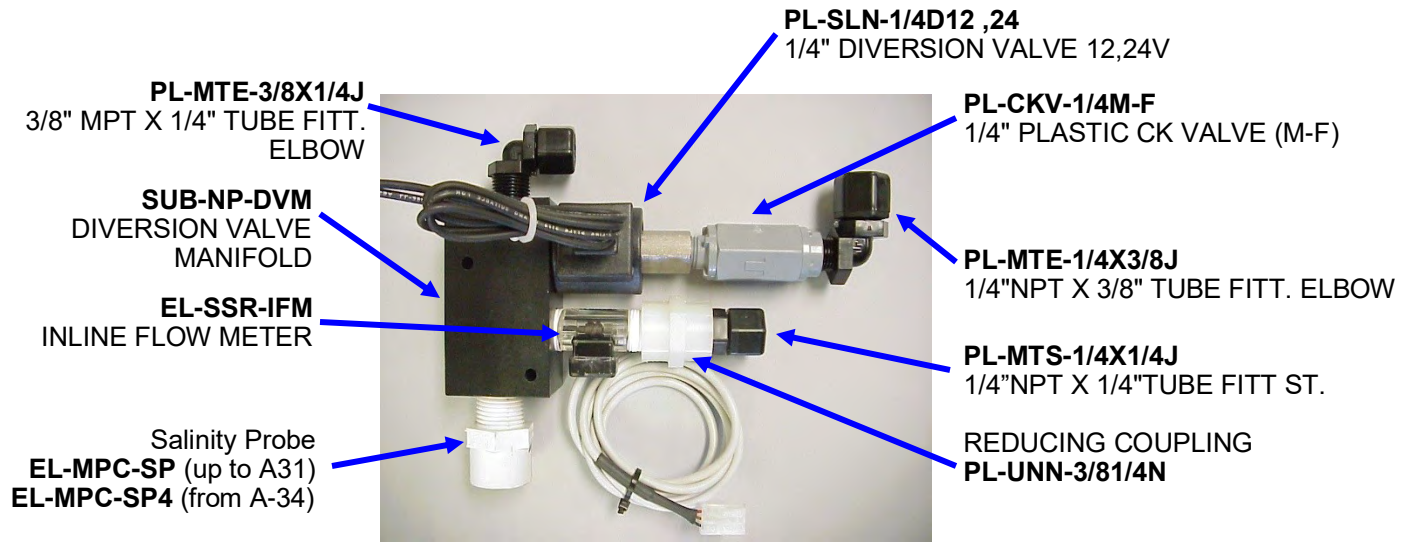

MONTEREY Parts

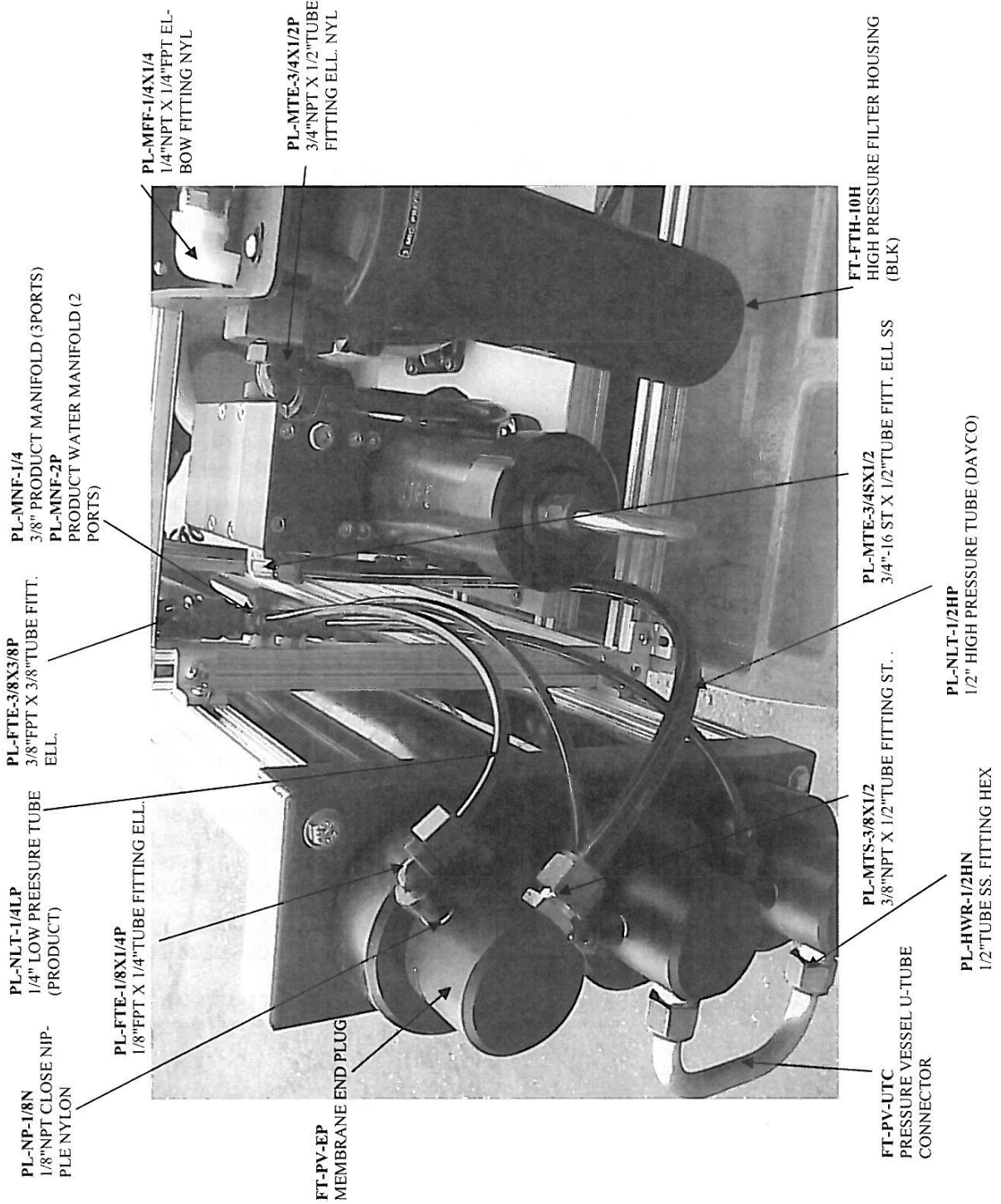

MONTEREY Parts

EL-MPC-PCB
MPC CIRCUIT BOARD

EL-SWT-TK1
S,P,/S.T. (ON-OFF) SWITCH

EL-MPC-RMCD
MPC REMOTE CONTROL (LCD)
EL-MPC-RMCF
MPC REMOTE CONTROL (VFD)

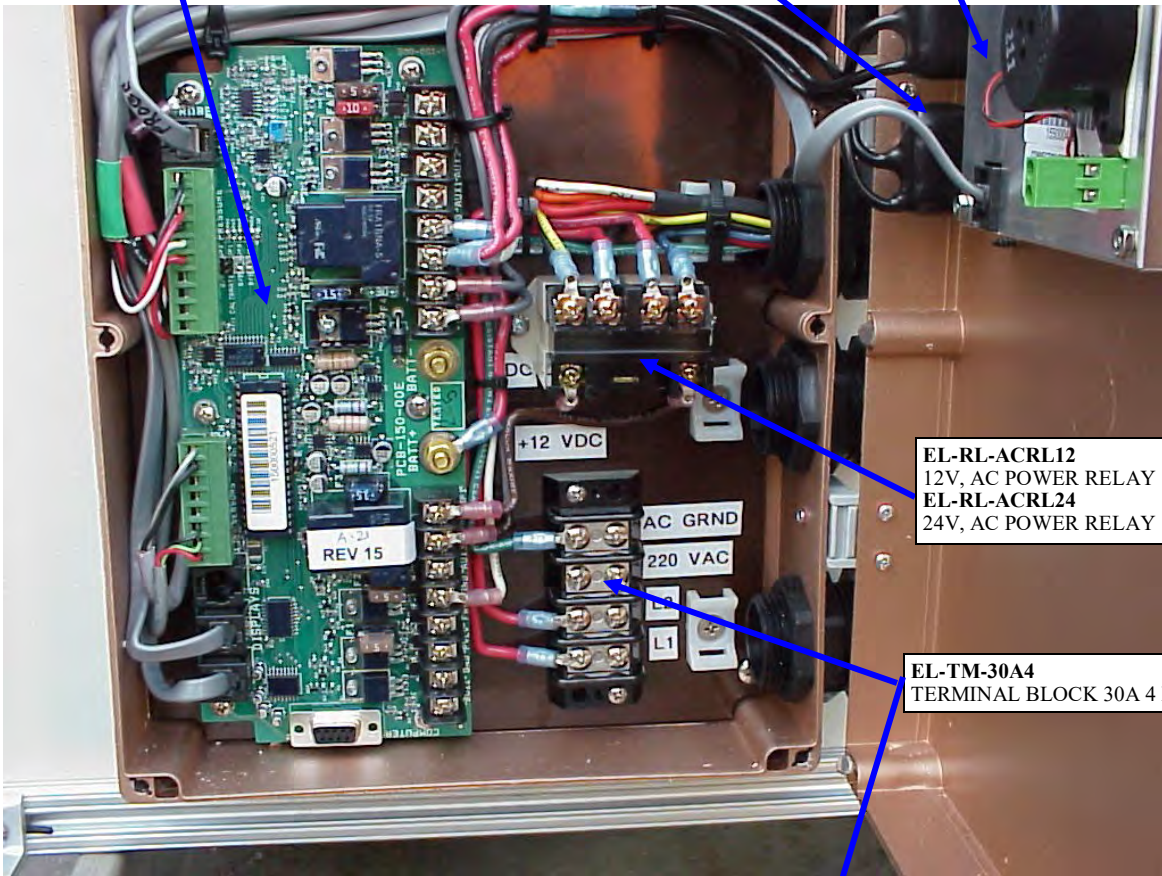

EL-RL-ACRL12
12V, AC POWER RELAY
EL-RL-ACRL24
24V, AC POWER RELAY

EL-TM-30A4
TERMINAL BLOCK 30A 4 POS.

EL-RL-PRL12
POWER RELAY 12V
EL-RL-PRL24
POWER RELAY 24V

EL-TM-30A2
TERMINAL BLOCK
30A 2 POS.

EL-TM-1/4PP
POWER POST (1/4")

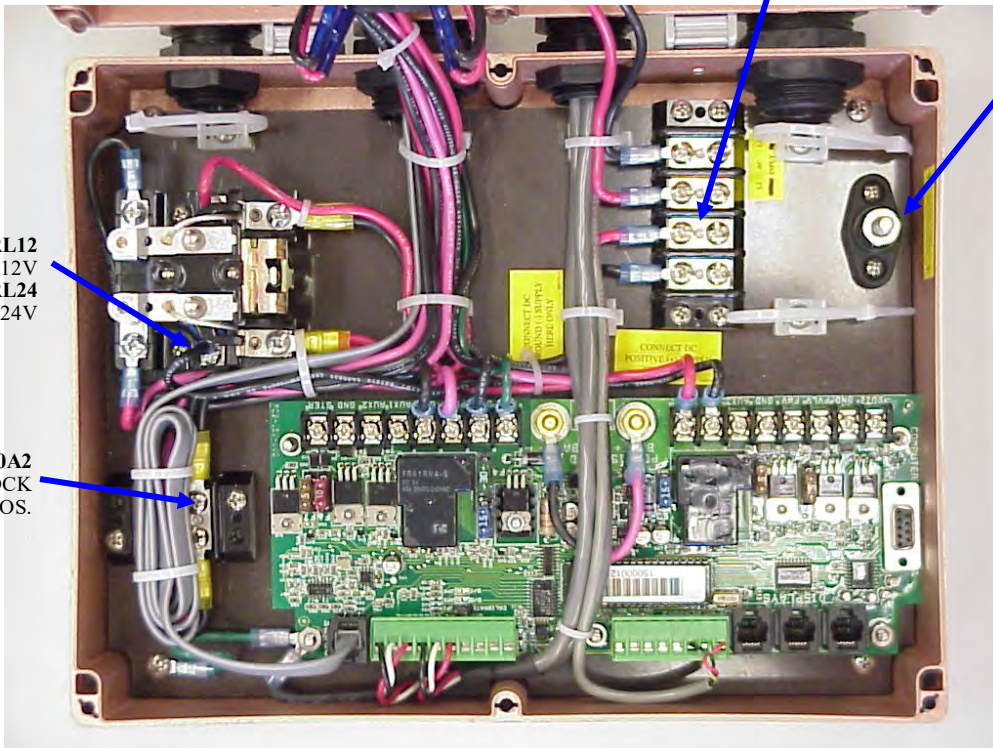

MONTEREY Parts

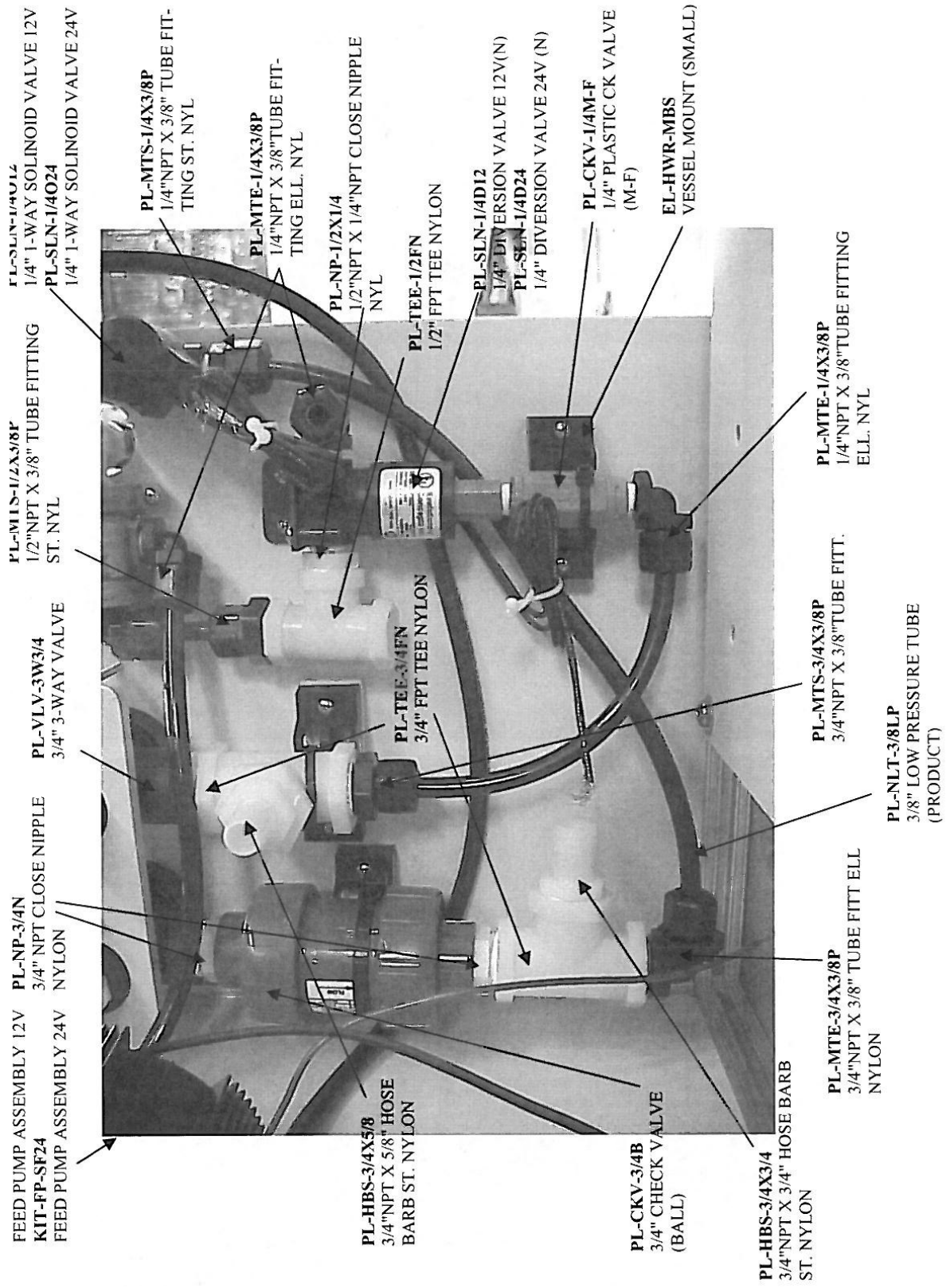

FEED PUMP ASSEMBLY 12V
KIT-PP-SF24

FEED PUMP ASSEMBLY 24V

PL-NP-3/4N
3/4" NPT CLOSE NIPPLE
NYLON

PL-VLV-3W3/4
3/4" 3-WAY VALVE

PL-MTS-1/2X3/8P
1/2" NPT X 3/8" TUBE FITTING
ST. NYL

PL-SLN-1/4U12
1/4" 1-WAY SOLINOID VALVE 12V

PL-SLN-1/4O24
1/4" 1-WAY SOLINOID VALVE 24V

PL-HBS-3/4X5/8
3/4" NPT X 5/8" HOSE
BARB ST. NYLON

PL-MTS-1/4X3/8P
1/4" NPT X 3/8" TUBE FIT-
TING ST. NYL

PL-MTE-1/4X3/8P
1/4" NPT X 3/8" TUBE FIT-
TING ELL. NYL

PL-NP-1/2X1/4
1/2" NPT X 1/4" NPT CLOSE NIPPLE
NYL

PL-TEE-1/2FN
1/2" FPT TEE NYLON

PL-TEE-3/4FN
3/4" FPT TEE NYLON

PL-SLN-1/4D12
1/4" DIVERSION VALVE 12V(N)

PL-SEN-1/4D24
1/4" DIVERSION VALVE 24V (N)

PL-CKV-1/4M-F
1/4" PLASTIC CK VALVE
(M-F)

EL-HWR-MBS
VESSEL MOUNT (SMALL)

PL-CKV-3/4B
3/4" CHECK VALVE
(BALL)

PL-HBS-3/4X3/4
3/4" NPT X 3/4" HOSE BARB
ST. NYLON

PL-MTE-3/4X3/8P
3/4" NPT X 3/8" TUBE FITT
NYLON

PL-MTS-3/4X3/8P
3/4" NPT X 3/8" TUBE FITT.

PL-NLT-3/8LP
3/8" LOW PRESSURE TUBE
(PRODUCT)

PL-MTE-1/4X3/8P
1/4" NPT X 3/8" TUBE FITTING
ELL. NYL

MONTEREY Parts

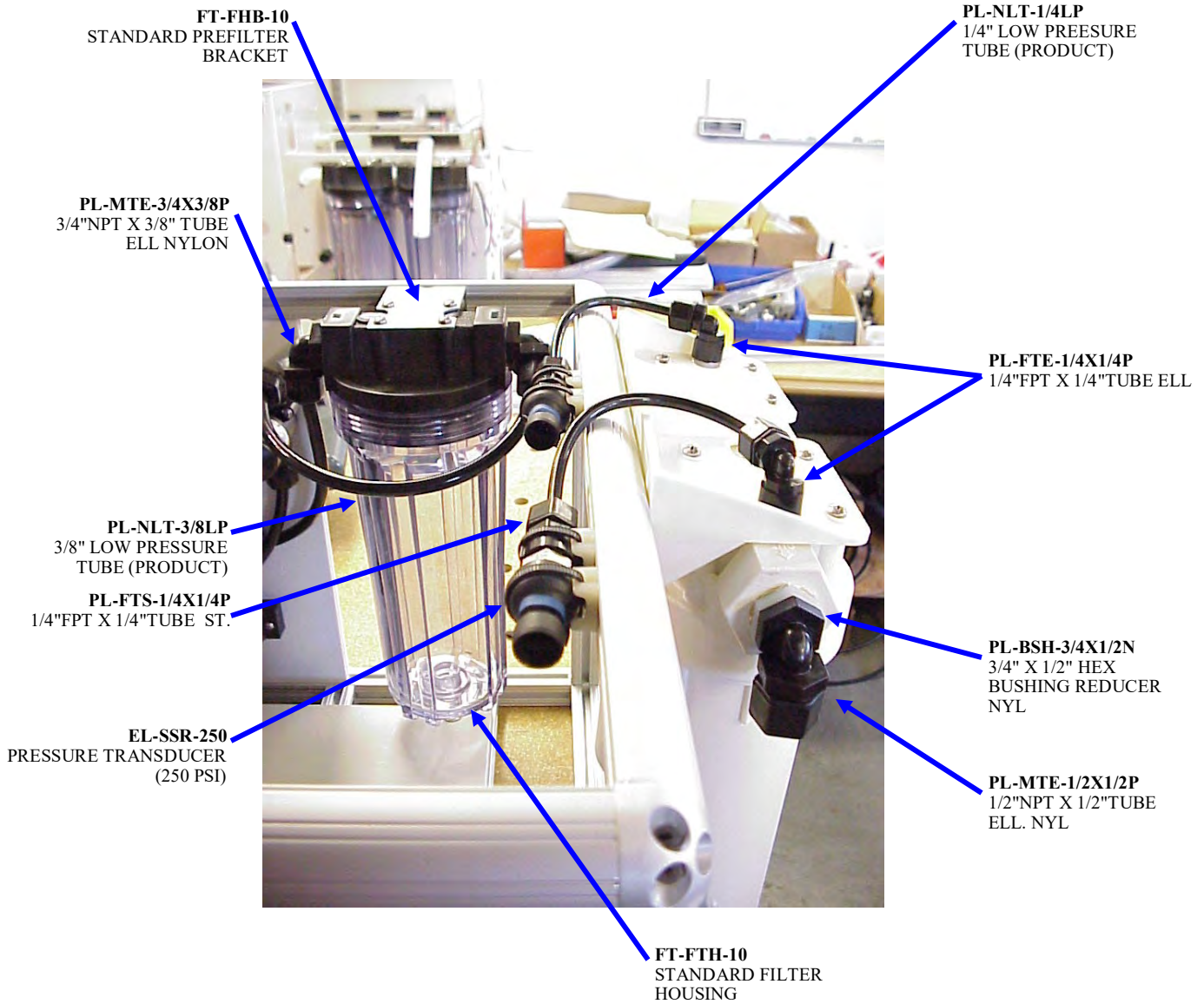

MONTEREY Parts

PL-FTE-1/4X1/4P
1/4" FPT X 1/4" TUBE ELL

PL-NP-1/4N
1/4" NPT CLOSE
NIPPLE NYLON

FT-FHB-10HD
HIGH PRESS.
HOUSING BRACKET
DUPLX

FT-FTH-10H
HIGH PRESSURE
FILTER HOUSING

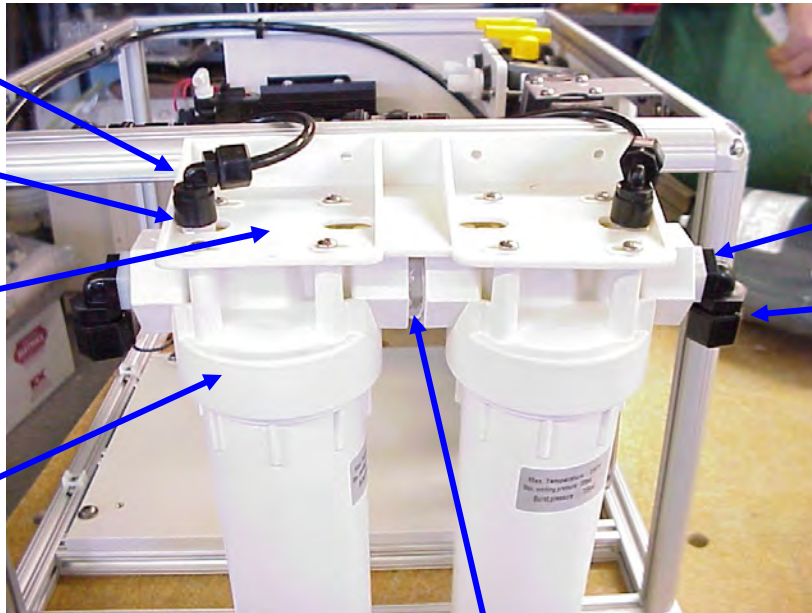

PL-BSH-3/4X1/2N
3/4" X 1/2" HEX BUSHING
REDUCER NYL

PL-MTE-1/2X1/2P
1/2" NPT X 1/2" TUBE FIT-
TING ELL. NYL

PL-NP-3/4N
3/4" NPT CLOSE NIPPLE NYLON

PL-VLV-3W3/4
3/4" 3-WAY VALVE

KIT-FP-SF12
FEED PUMP 12V
KIT-FP-SF24
FEED PUMP 24V

PL-HBE-3/8X5/8
3/8" NPT X 5/8" HOSE
BARB ELL NYLON

PL-SLN-1/4O12
1/4" 1-WAY SOLINOID
VALVE 12V

PL-SLN-1/4O24
1/4" 1-WAY SOLINOID
VALVE 24V

FT-FTH-10
STANDARD FILTER
HOUSING

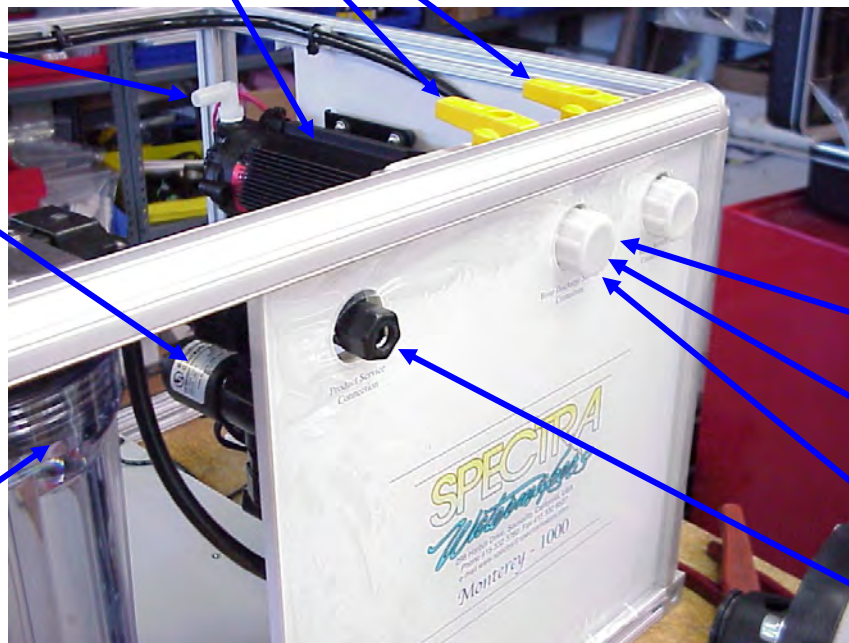

Hose Fitting Washer
PL-GHF-WS

Hose Fitting Cap
PL-GHF-GC

Hose Fitting
PL-GHF-3/4x1/2

Tube Fitting
PL-MTS-1/4X3/8P

MONTEREY Parts

PL-PSG-HP2.5
2.5"D,1/4"NPT PRESS. GAUGE
0-300PSI

PL-BSH-1/2X1/4S
1/2" X 1/4" HEX BUSHING
REDUCER SS.

PL-TEE-3/8FS
3/8" FPT TEE FITTING SS.

PL-CLP-10SS
#10 HOSE CLAMP

PL-HS-3/4SH
3/4" REINFORCE
SUCTION HOSE

PL-HBE-1/2X3/4
1/2"NPT X 3/4"
HOSE BARB ELBOW

PL-NP-3/8S
3/8" NPT CLOSE NIPPLE SS.

PL-PMP-PCA
MOTOR COUPLING
AND ADAPTOR

PL-PMP-VBC
V-BAND CLAMP FOR
ROTARY VANE PUMP



EL-SSR-250
PRESSURE TRANSDUCER
(250 PSI)

PL-MTE-3/8X1/2P
3/8"NPT X 1/2" TUBE
FITTING ELL NYL

PL-NLT-1/2HP
1/2" HIGH PRESSURE TUBE
(DAYCO)

KIT-PMP-240ERF
FEED PUMP HEAD

SANTA CRUZ Parts

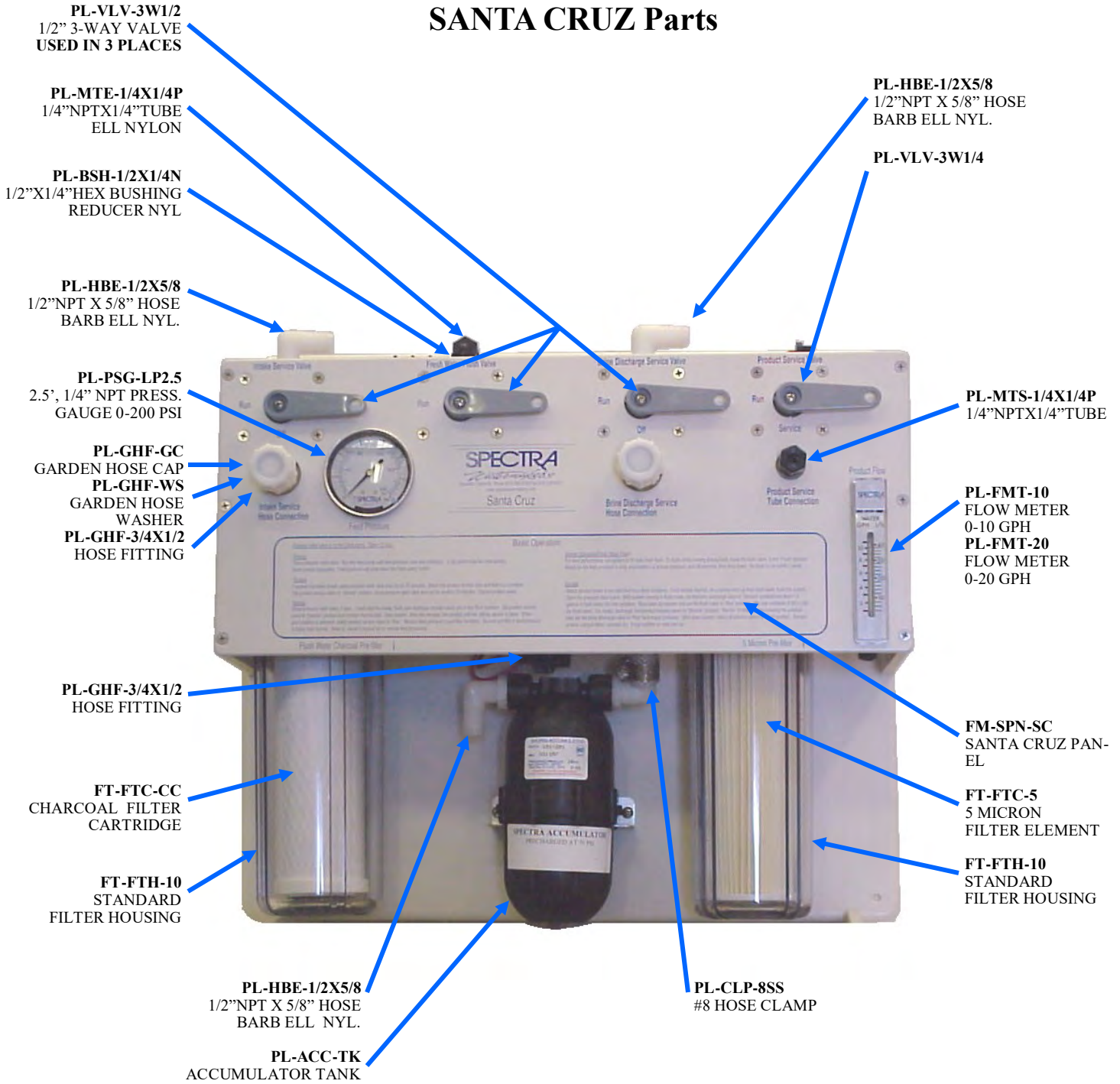

SANTA CRUZ Parts

Back side of front panel

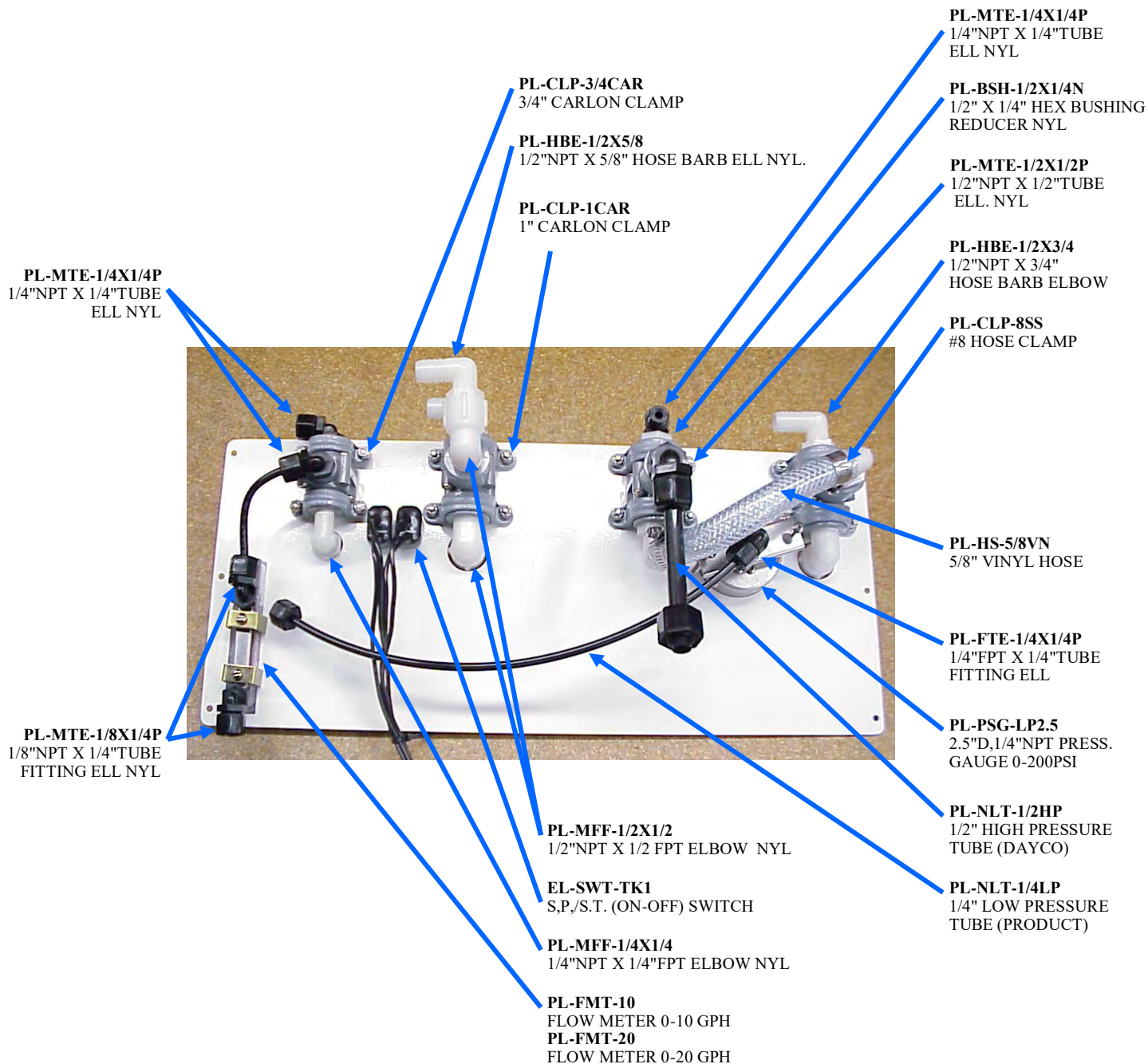

SANTA CRUZ Parts

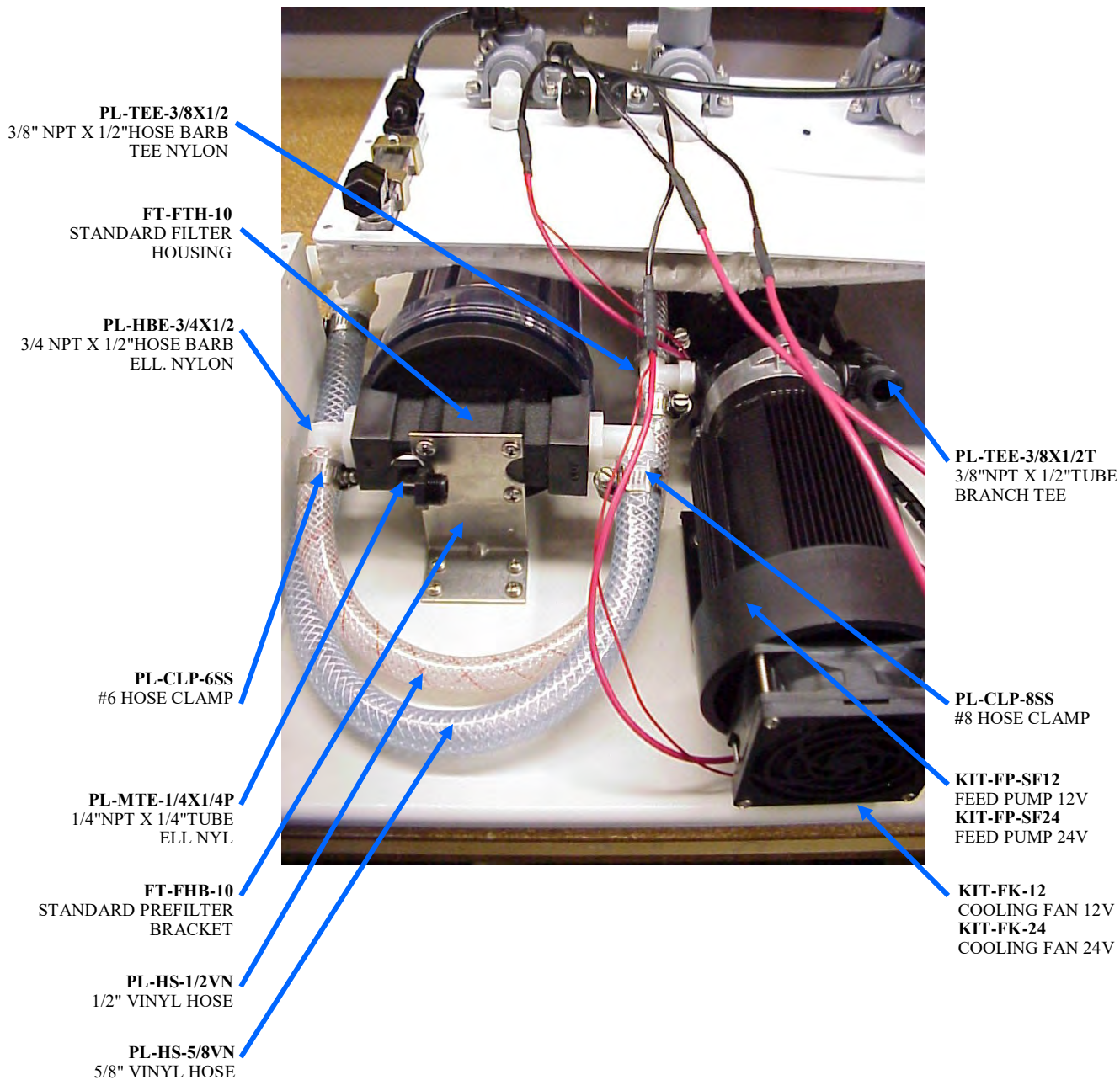

GULFSTREAM 400

PL-FMT-20
FLOW METER (20GPH)

PL-PSG-LP2.5
2.5"D, 1/4"NPT PRESS.
GAUGE 0-200PSI

HP-TB-BV
BLEED VALVE

PL-VLV-3WK1/2
1/2" THREE WAY
VALVE

PL-GHF-GC
GARDEN HOSE CAP
PL-GHF-WS
GARDEN HOSE
WASHER VINLY
PL-GHF-3/4X1/2
3/4"MGHT X 1/2"MALE
NIPPLE

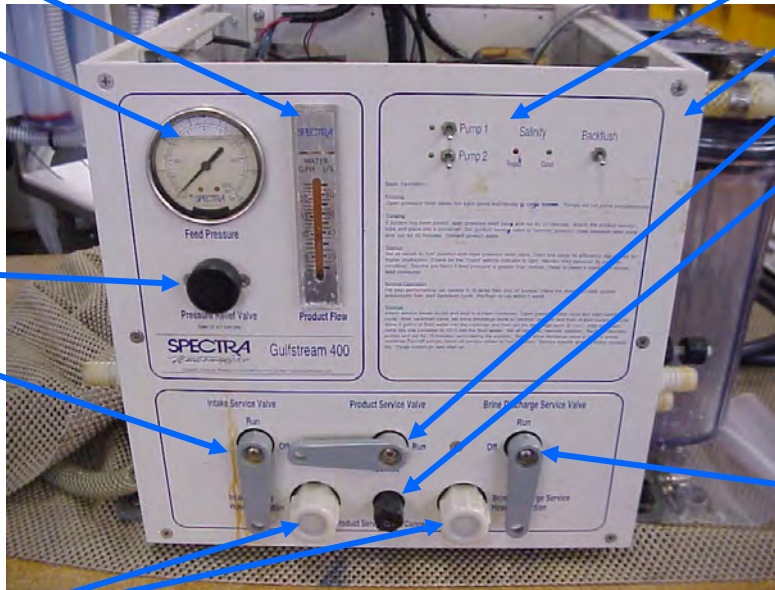

FM-KIT-ABFP
AUTO BACKFLUSH PANEL

FM-SPN-GULF
GULFSTREAM PANEL**

PL-VLV-3WK1/4
1/4" THREE WAY VALVE KIT

PL-MTS-1/4X1/4P
1/4"NPT X 1/4" TUBE ST. NYL

PL-VLV-3WK1/2
1/2" THREE WAY VALVE
KIT**

PL-TEE-3/4M5/8B
3/4"MPT X 5/8"HB X 5/8" HB TEE

PL-BHF-1/4U
1/4" BULKHEAD UNION

PL-HBS-3/8X5/8
3/8"NPT X 5/8" HOSE
BARB ST. NYLON

PL-HBS-3/8X5/8
3/8"NPT X 5/8" HOSE BARB
ST. NYLON

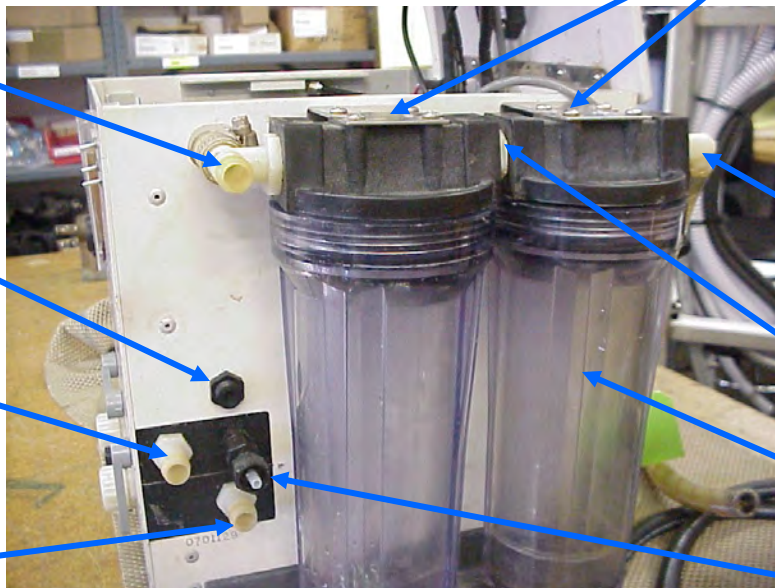

FT-FHB-10
STANDARD PREFILTER
BRACKET

PL-HBE-3/4X5/8
3/4"NPT X 5/8" HOSE BARB
ELL NYLON

PL-NP-3/4N
3/4" NPT CLOSE NIPPLE

FT-FTH-10
STANDARD FILTER
HOUSING

PL-MTS-1/4X1/4P
1/4"NPT X 1/4" TUBE
ST. NYL

GULFSTREAM 400



PL-MTE-1/4X1/4P
1/4"NPT X 1/4" TUBE
ELL NYL

PL-HBS-3/8X5/8
3/8"NPT X 5/8" HOSE
BARB ST. NYLON

EL-SLT-CTRL
SALINITY CONTROLLER

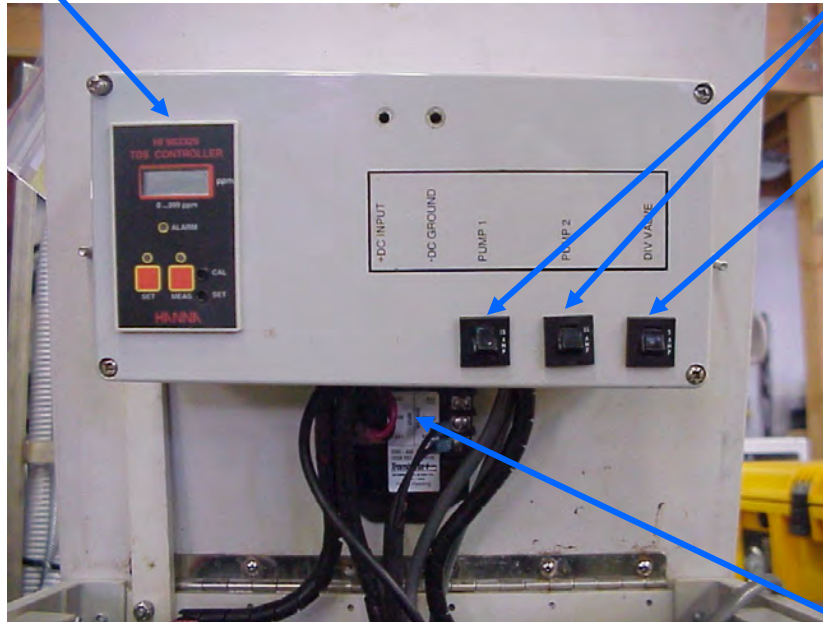

EL-BRK-15A1
15A BREAKER
EL-BRK-7.5A
7.5A BREAKER

EL-BRK-5A
5A BREAKER
EL-BRK-3A
3A BREAKER

EL-ELM-DCM
DC MODULE FOR
SOLINOID VALVE

GULFSTREAM 400

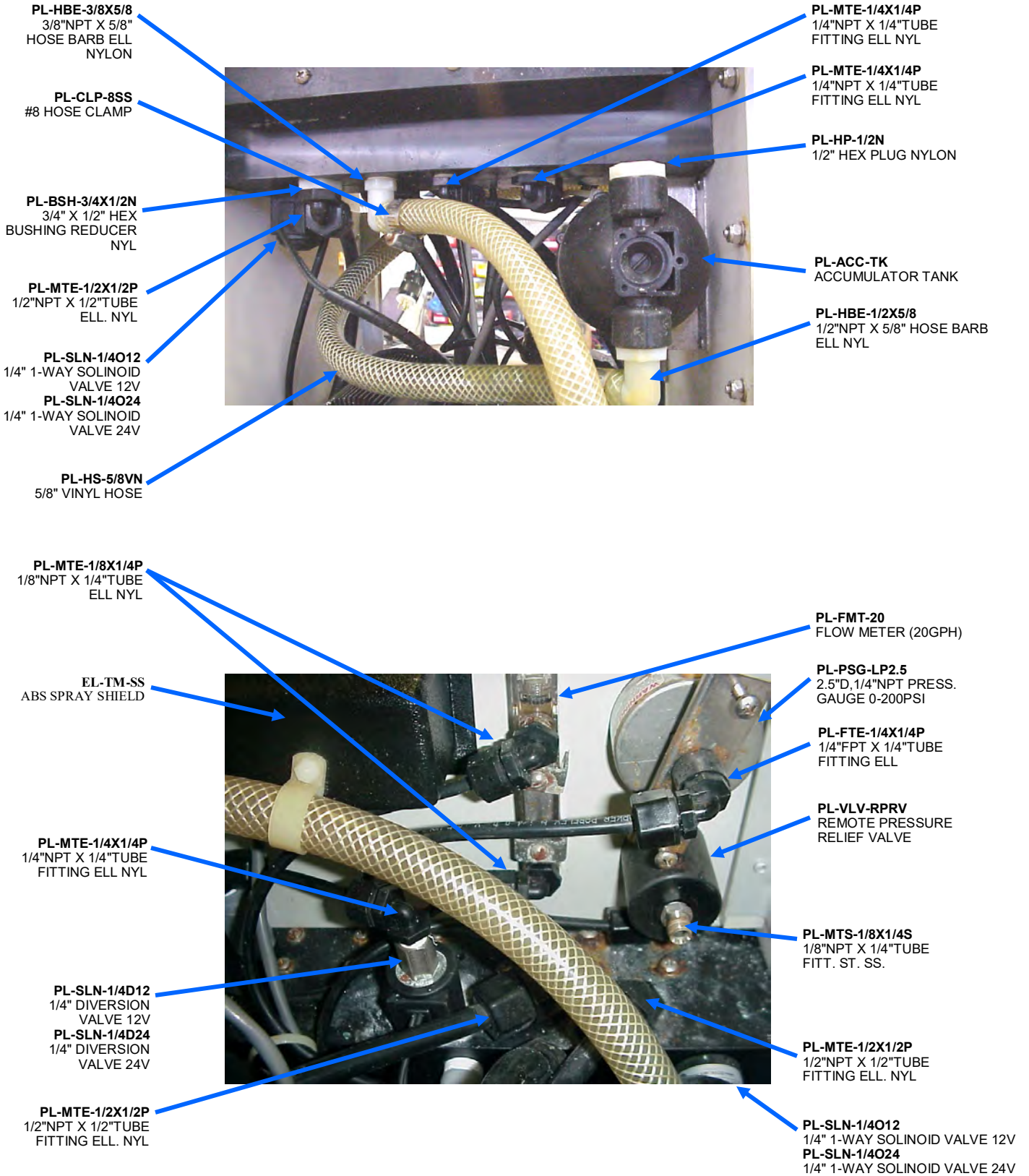

GULFSTREAM 400

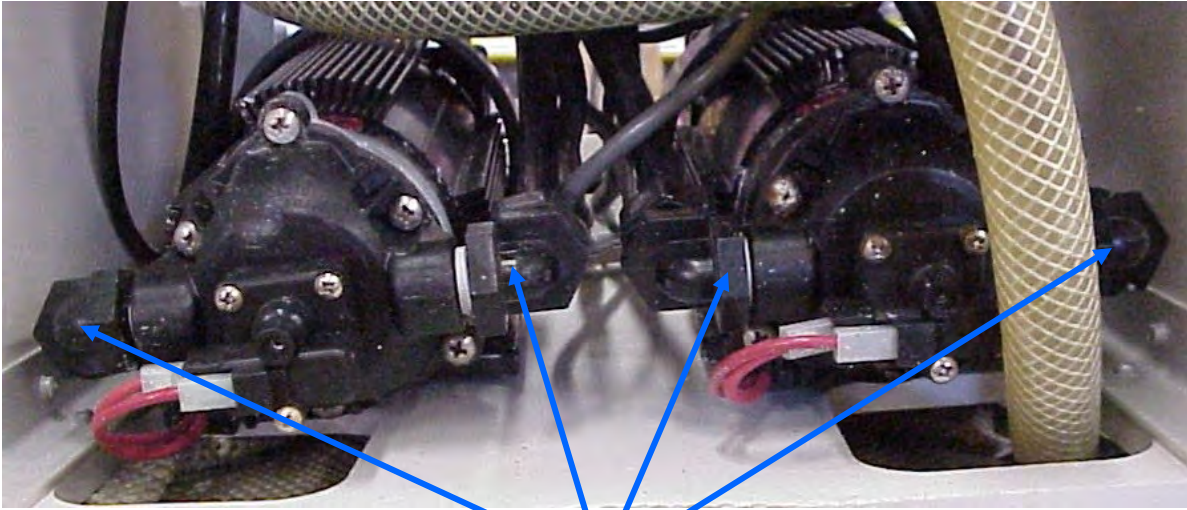

PL-MTE-3/8X1/2P
 3/8"NPT X 1/2" TUBE FITTING ELL
 NYL

EL-RL-40A12
 12V 40A CUBE RELAY
EL-RL-40A24
 24V, 40A CUBE RELAY

EL-RL-TRL12A
 12DC/CHDFA TIMER**
EL-RL-TRL24A
 24DC/CHDFA TIMER*

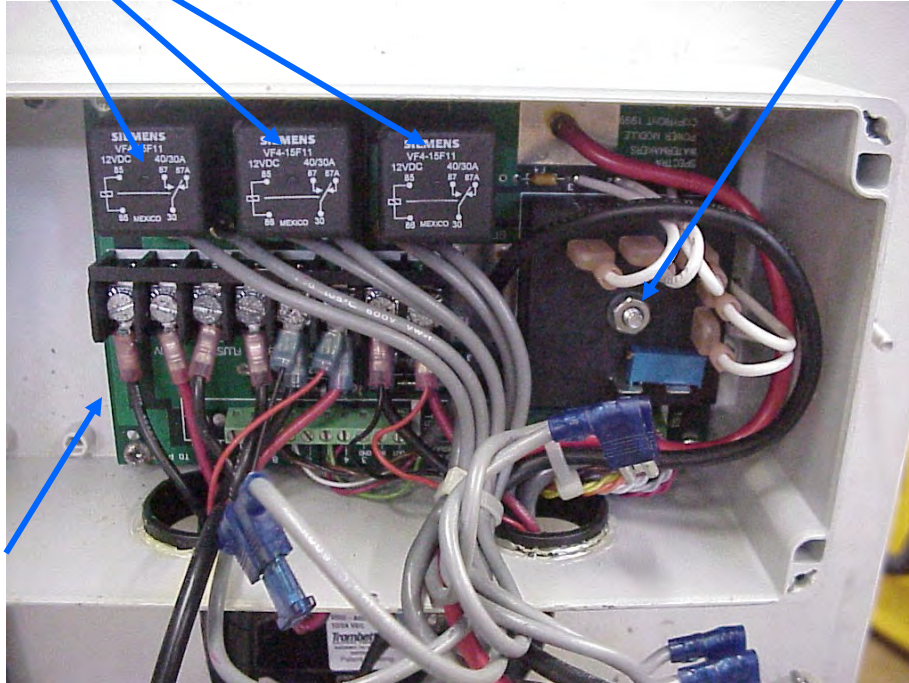

EL-ELM-CPCB
 Main Circuit Board

GULFSTREAM 400

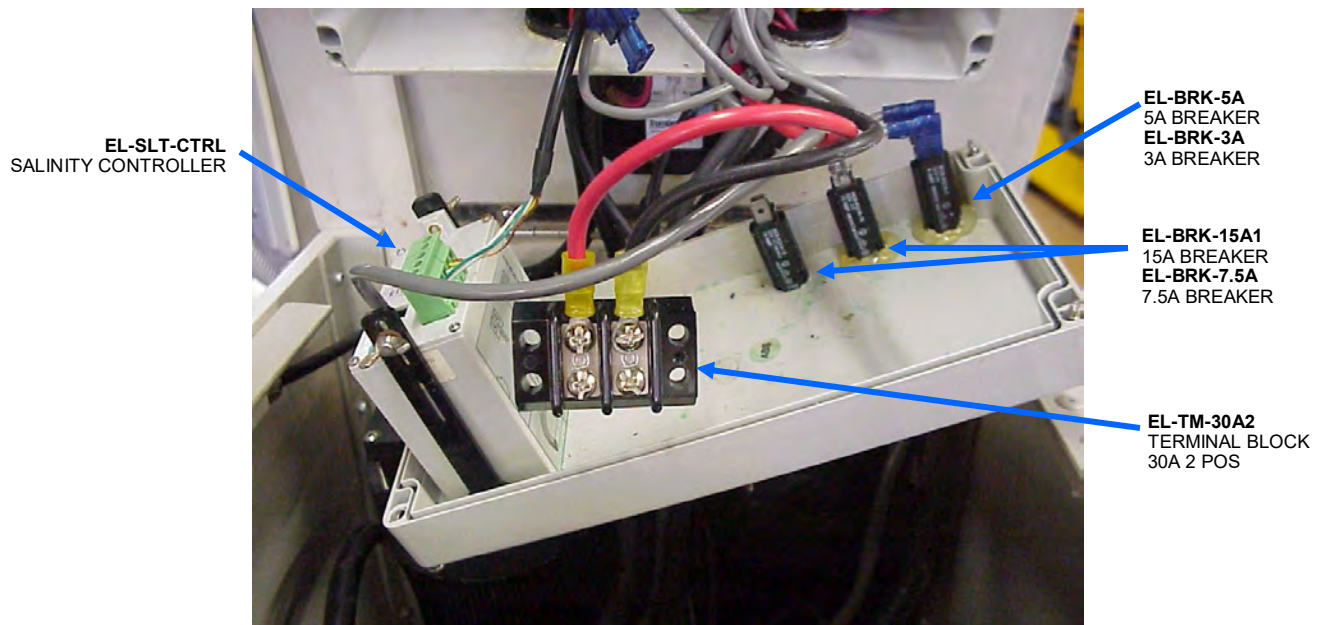
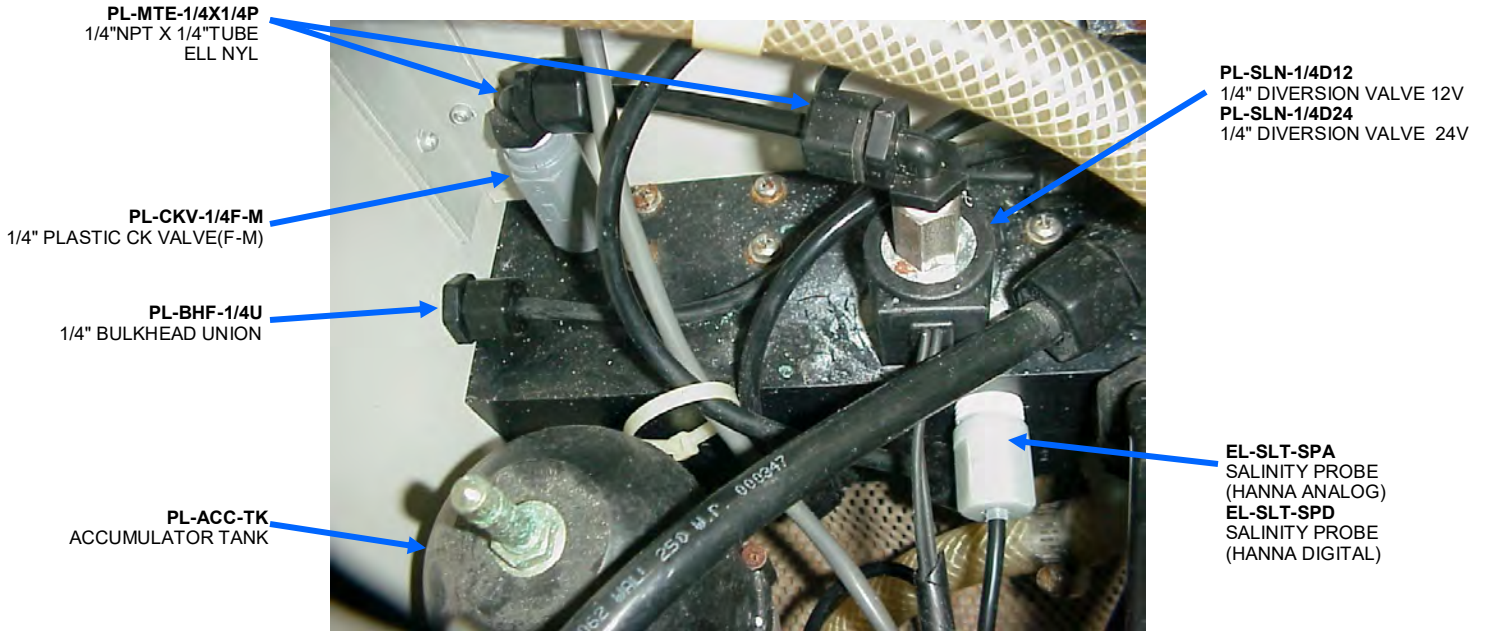

GULFSTREAM 400

KIT-FK-12
COOLING FAN KIT 12V
KIT-FK-24
COOLING FAN KIT 24V

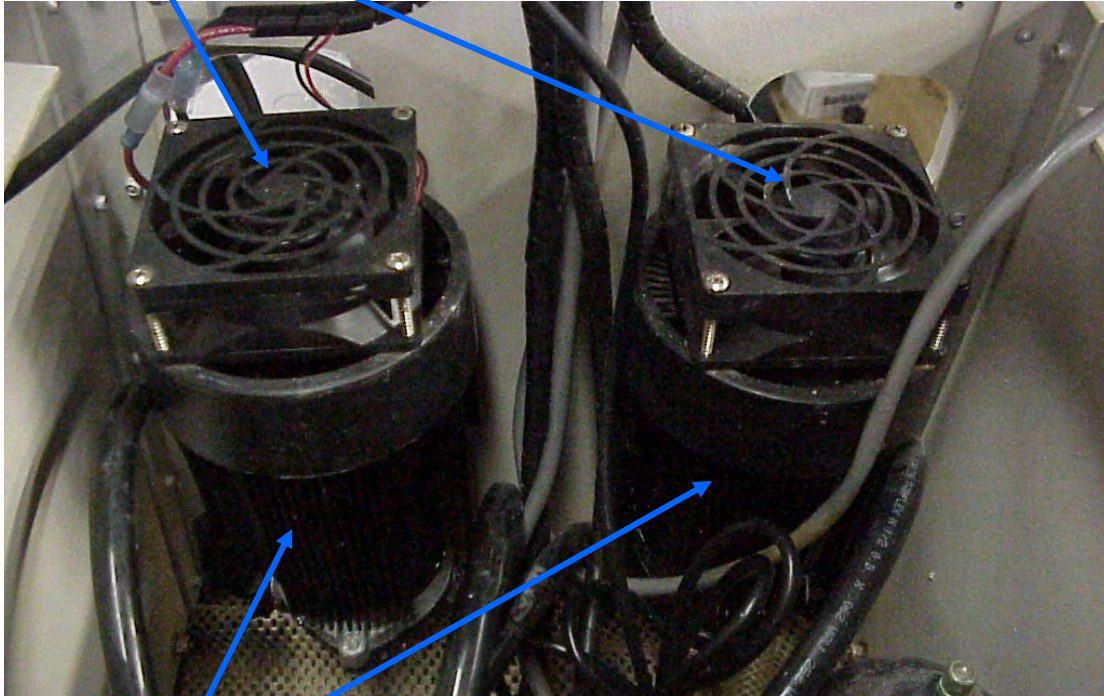

KIT-FP-SF12
FEED PUMP ASSEMBLY 12V
KIT-FP-SF24
FEED PUMP ASSEMBLY 24V

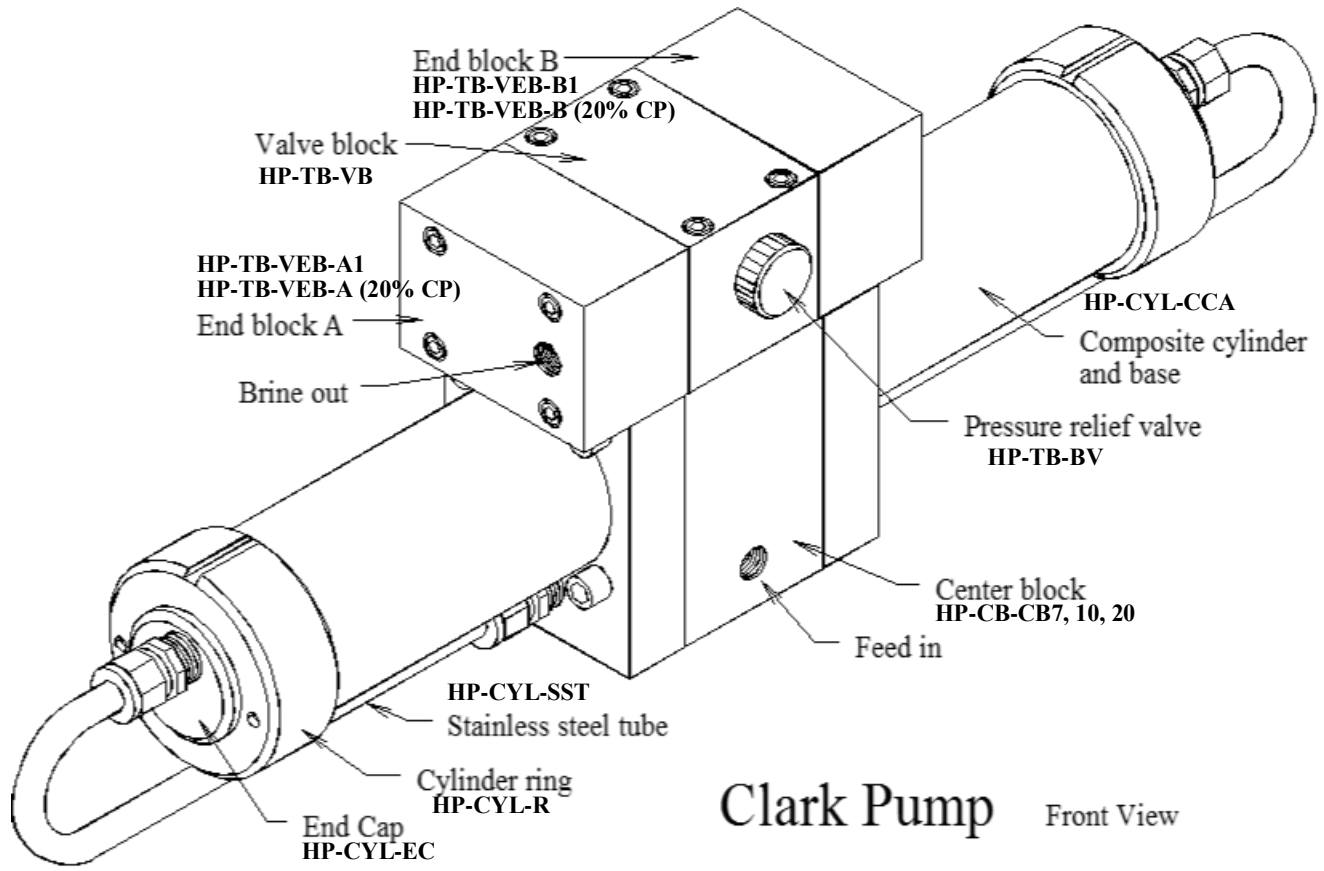

Clark Pump Front View

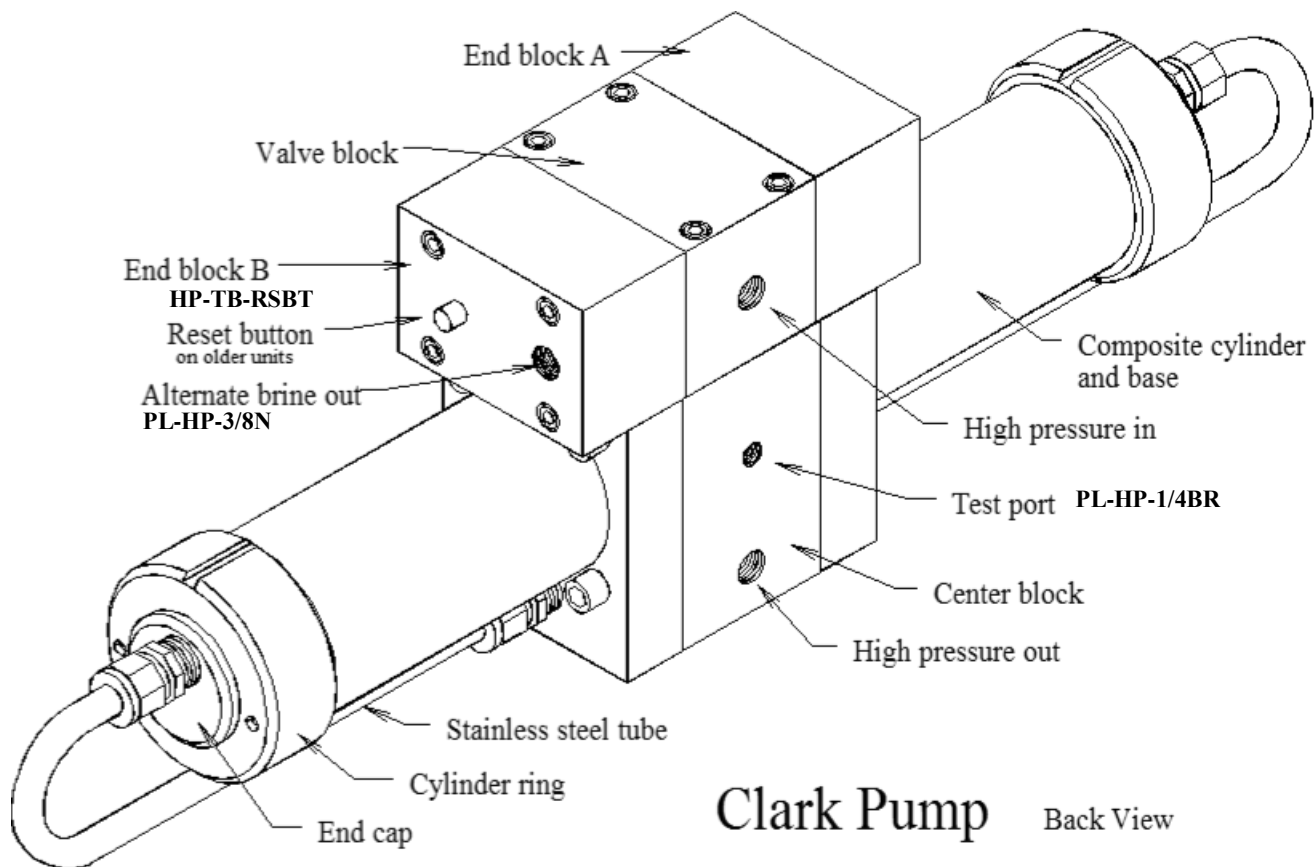

Clark Pump Back View

Spool Assembly Exploded View

(early style)

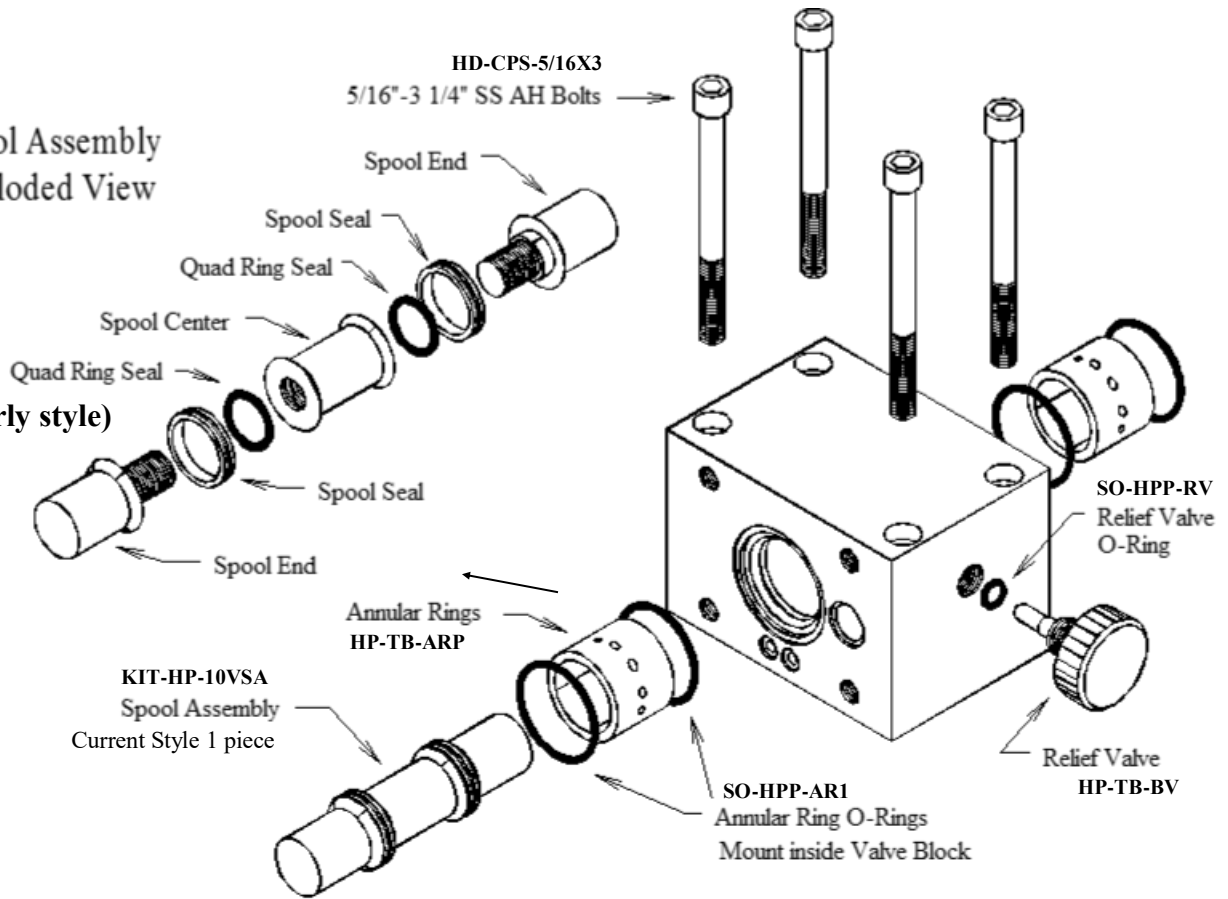

Valve Body

HP-TB-VB

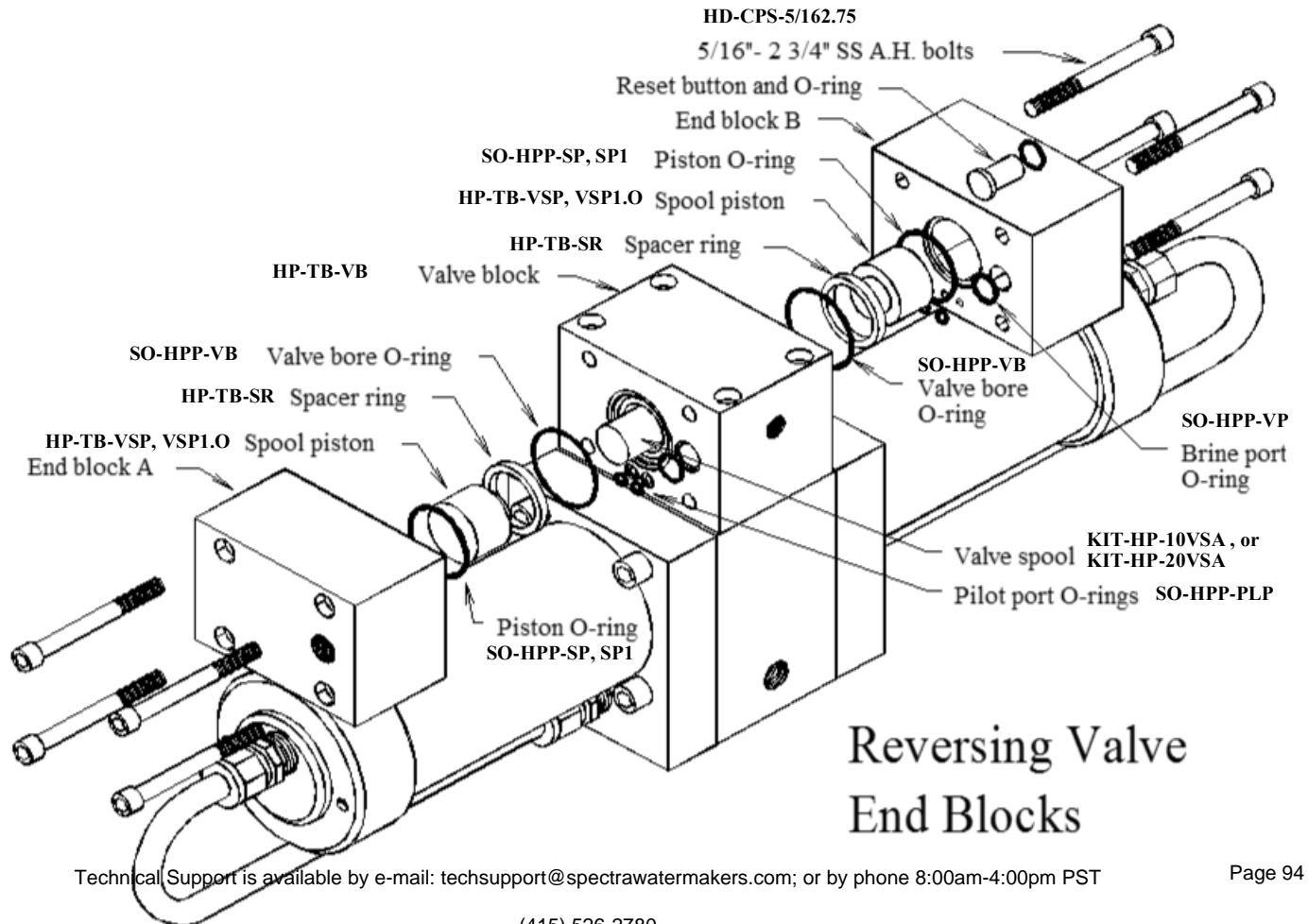

Reversing Valve End Blocks

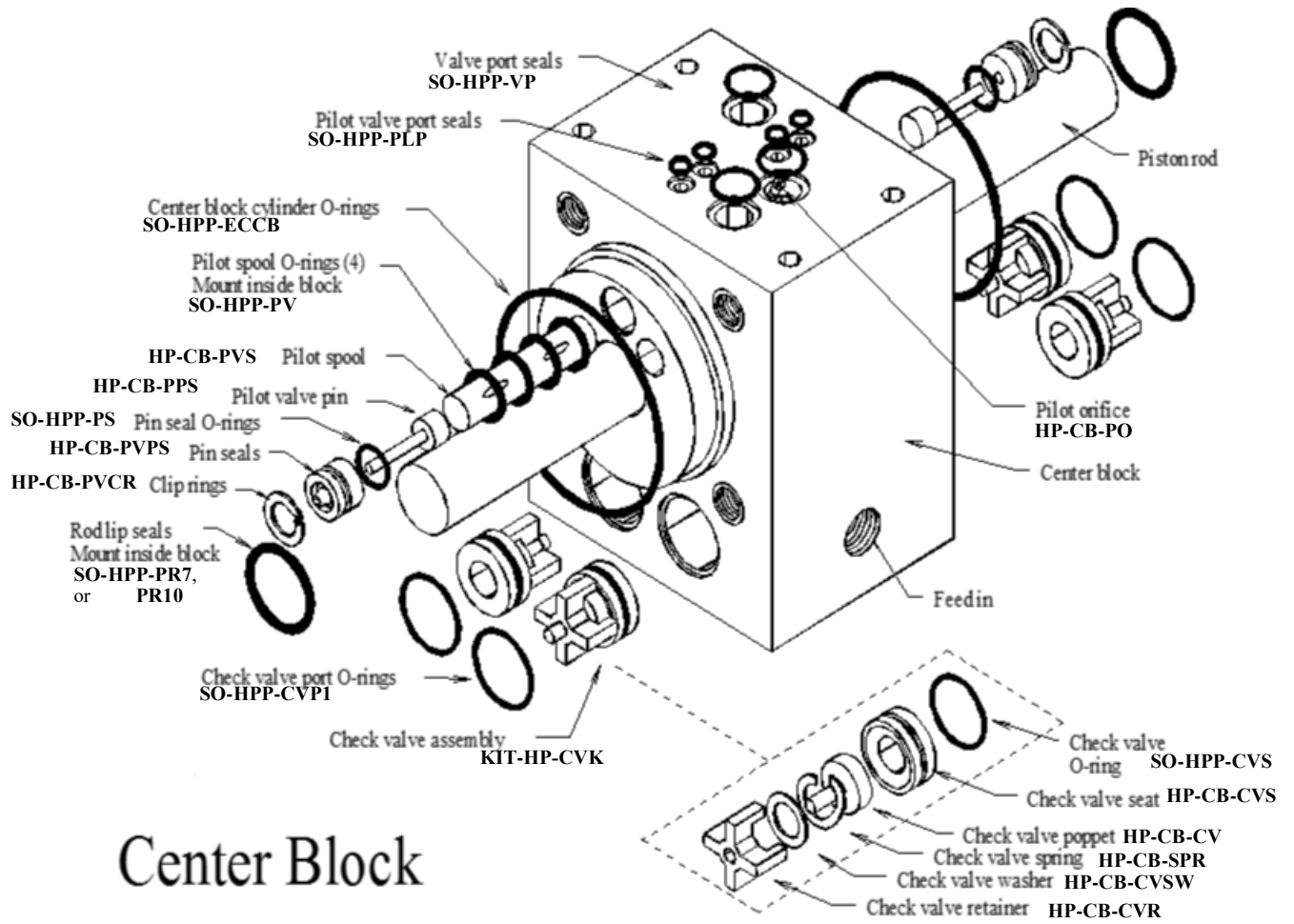

Center Block

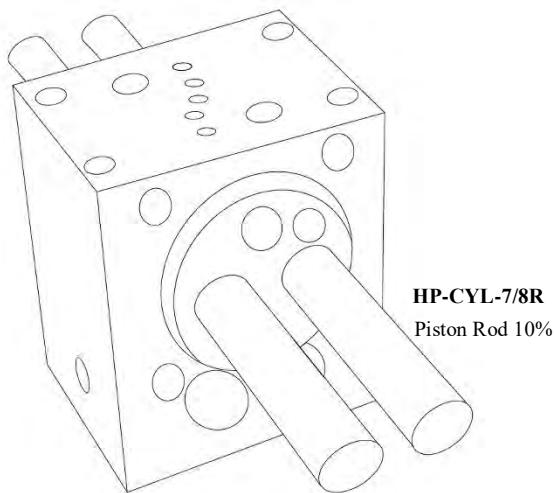

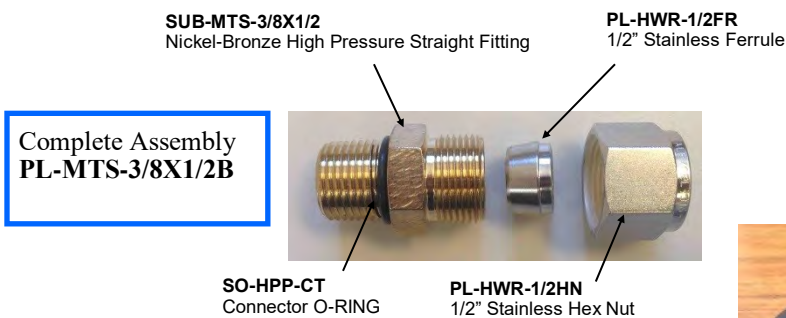
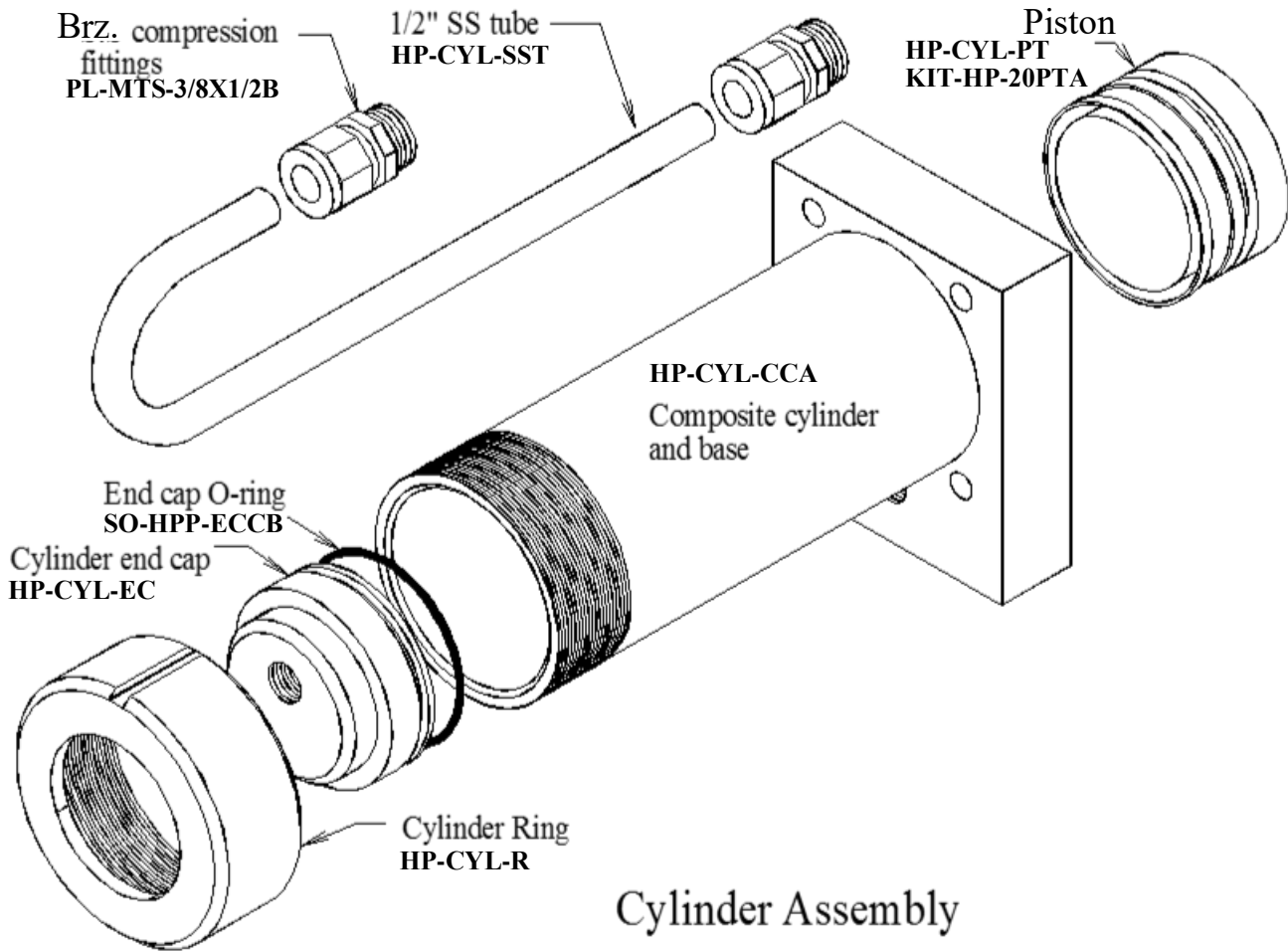

Katadyn PowerSurvivor 40E Exploded View Diagram, Pump

Pos.	Part # (801...)	DESCRIPTION	Pos.	Part # (801...)	DESCRIPTION	Kit # (801...)	DESCRIPTION
1	2700	SPIRAL RETAINING RING, 2-TURN	25	3390	NUT	2793	MEMBRANE KIT 35/40/80 / 604375127937
2	2947	O6 O-RING	26	3340	HOSE BARB, 3/8 HOSE X 1/4 NPT	3877	PLUNGER ROD KIT / 604375138773
3	2647	ELBOW BARB	27	2585	VALVE SEAT INLET	8615	RELIEF VALVE KIT WITH SOCKET PS40
4	2597	END PLATE	28	3015	70 O-RING	*PARTS WITHIN KITS ARE NOT SOLD INDIVIDUALLY	
5	2598	END PLUG	29	3009	64 O-RING		
6	3004	59 O-RING	30	2978	POPPET VALVE		
7	3147	QUAD SEAL, BRINE	31	3120	SPRING		
8	KIT ONLY 2793	MEMBRANE KIT 35/40/80 / 604375127937	32	2609	CHECK VALVE RETAINER		
9	3394	SLIDER CAP	33	3005	60 O-RING		
10	2779	BLOCK WIPER	34	2977	VALVE SEAT		
11	2776	WIPER SEAL, PARKER TYPE D-500	35	2590	CAPSCREW, SOCKET HD, 5/16-18 X 5		
12	2904	SPACER BLOCK	36	2599	CAPSCREW, SOCKET HD, 5/16-18 X 3		
13	2797	BUSHING	37	3389	CAPSCREW - SHORT		
14	2967	BACK-UP WASHER	38	2581	40E CHECK VALVE PLATE		
15	3013	68 O-RING	39	2595	MEMBRANE TUBE PLUG		
16	2785	STUD - SHORT, 5/16 UNC X 1-1/4L	40	KIT ONLY 8615	RELIEF VALVE KIT WITH SOCKET PS40		
17	2583	40E PUMP BACK PLATE	41	2697	O25 O-RING		
18	3388	PIN	42	2736	ELBOW, 1/4 NPT X 3/8 HB, PLASTIC		
19	3838	PISTON SHAFT	43	2594	38-O21 O-RING		
20	3008	63 O-RING	44	3986	40 BODY/MEMBRANE HOUSING		
21	2774	PISTON	45	KIT ONLY 6525	SPOOL VALVE KIT		
22	2775	U-CUP SEAL 1-1/8 ID, 1-1/2 OD, 5/16	46	3006	61 O-RING		
23	2899	FLAT WASHER	47	2588	38-O13 O-RING		
24	2796	PIP RING					

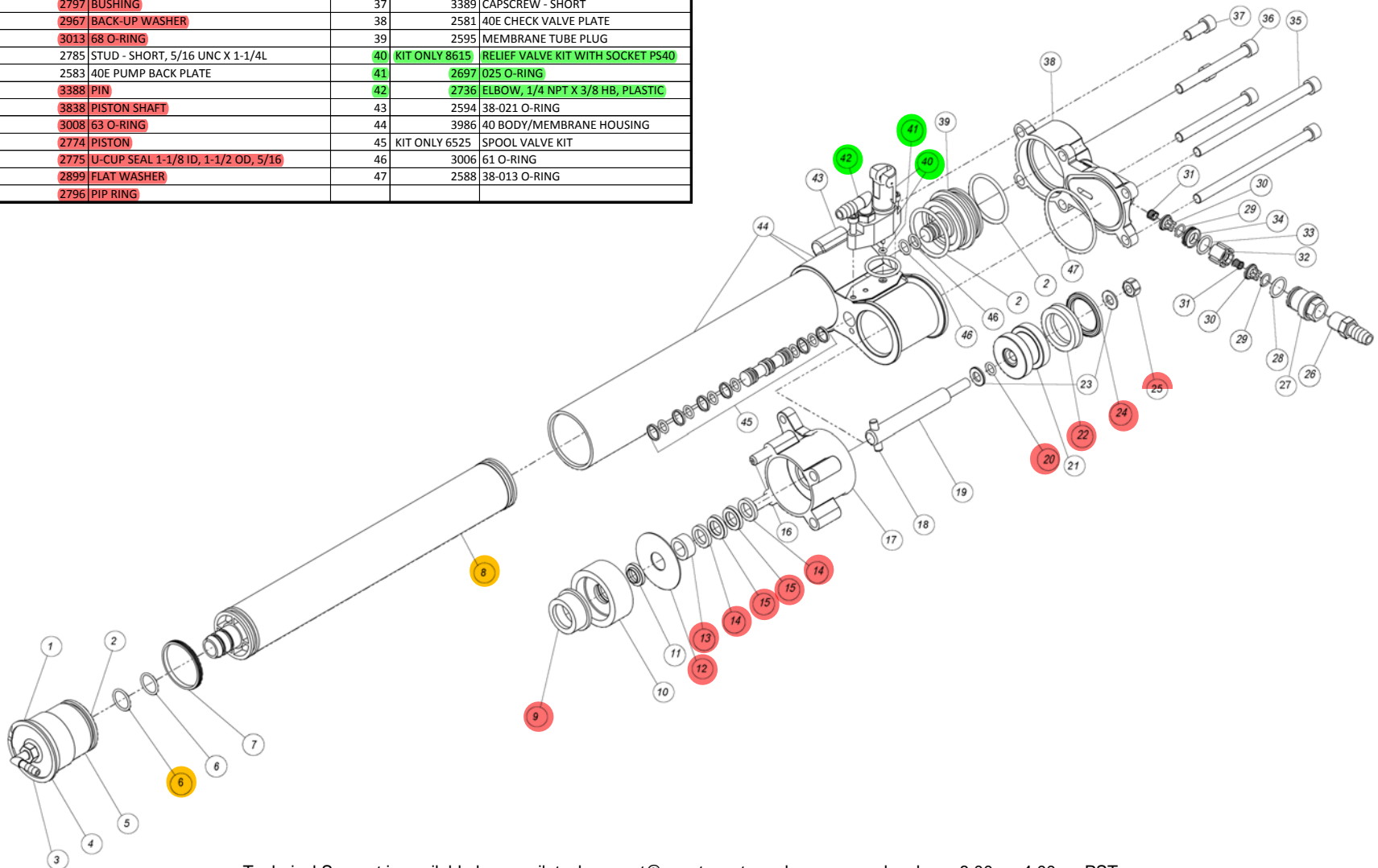

Technical Support is available by e-mail: techsupport@spectrawatermakers.com; or by phone 8:00am-4:00pm PST

PowerSurvivor[™] 40E 12-Volt & 24-Volt Watermakers



OWNER'S MANUAL

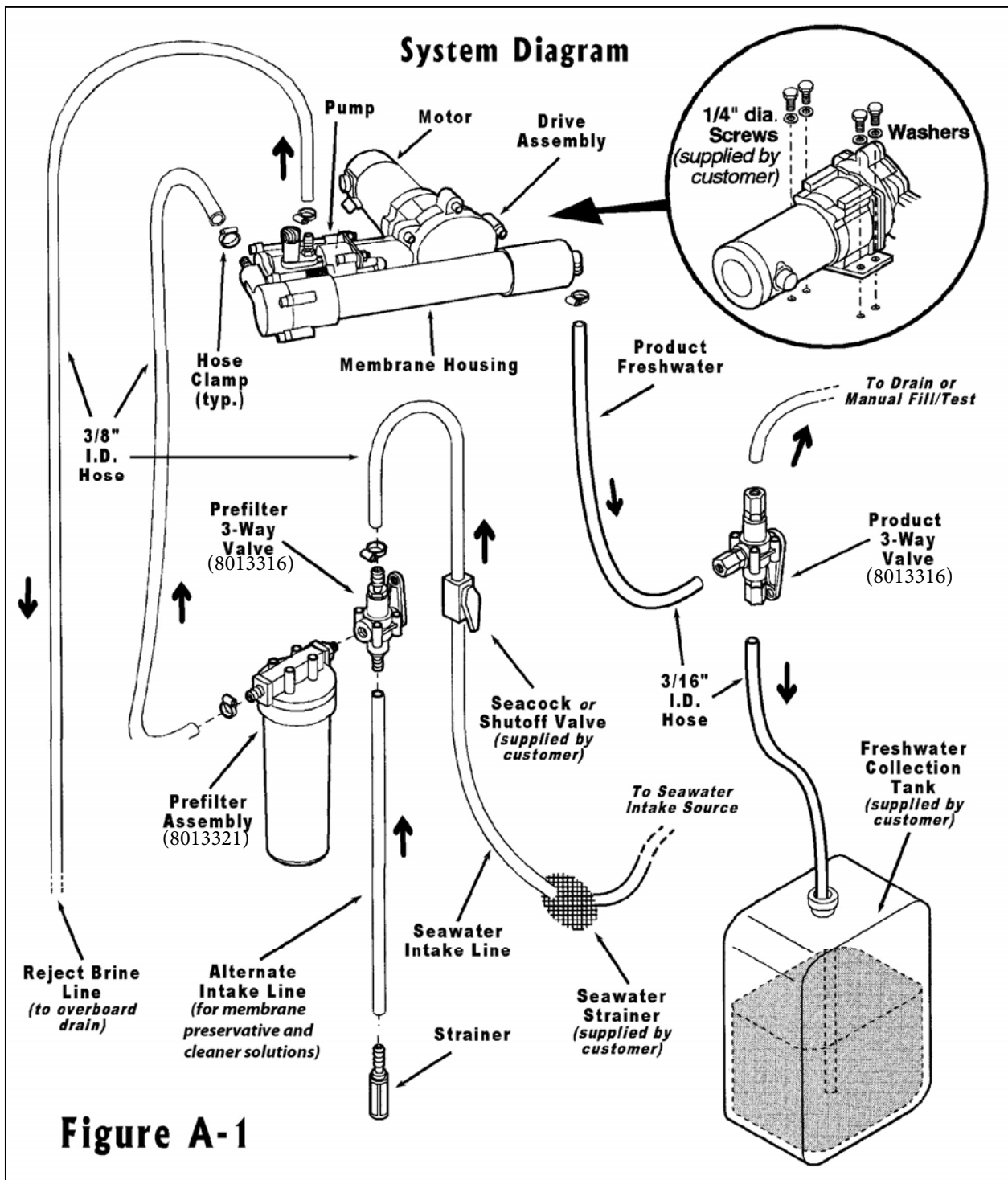

Pump Assembly Exploded Parts View

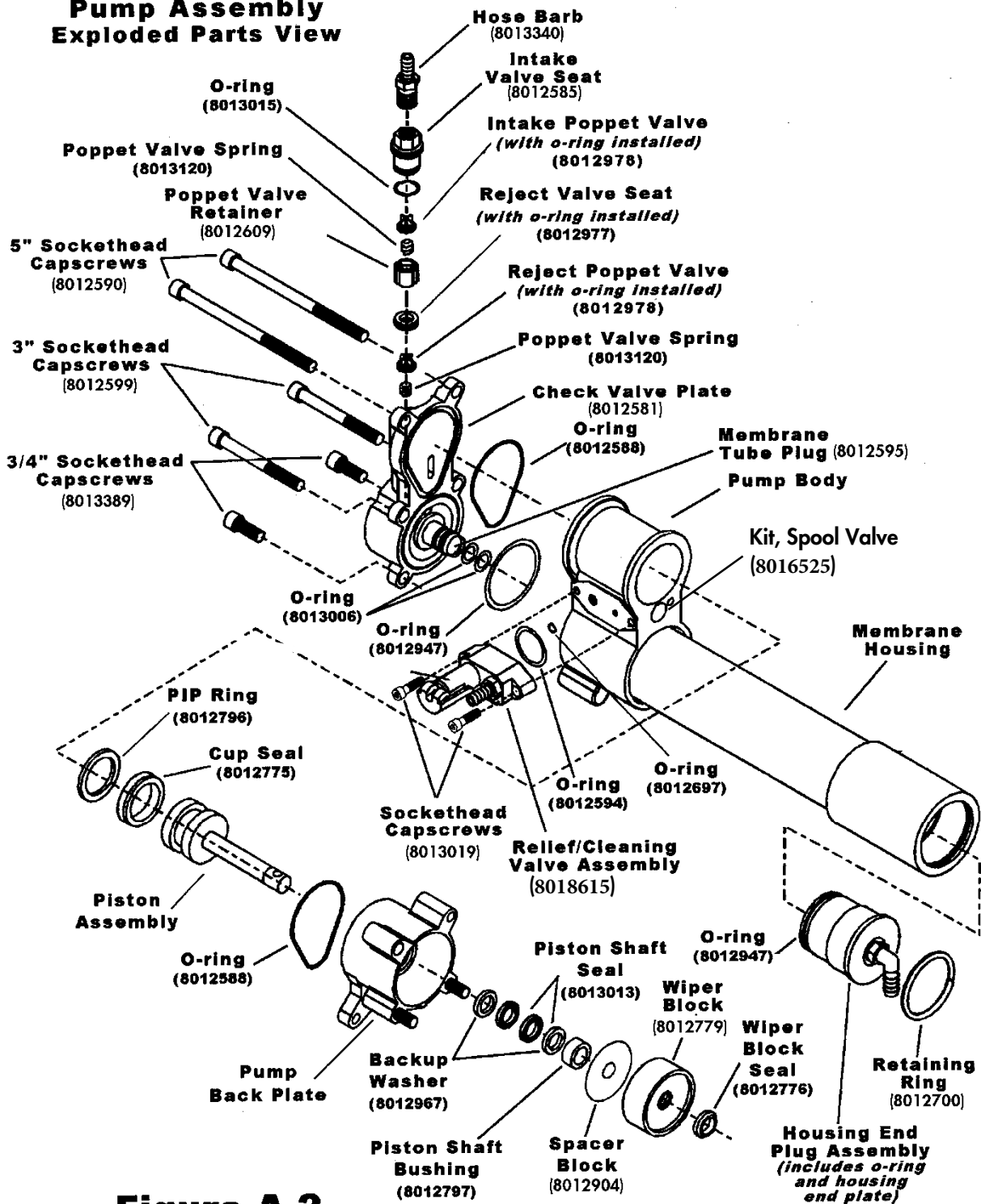
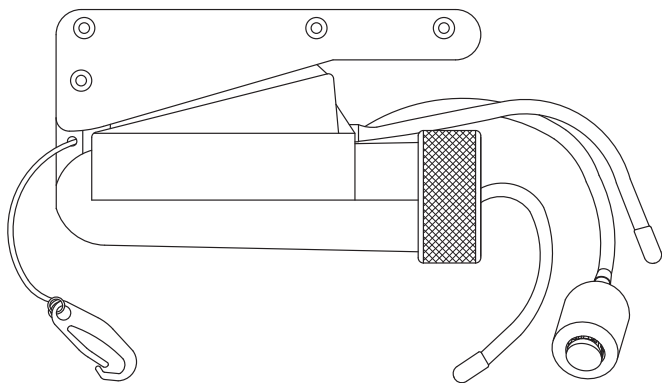

Figure A-2



MAKING WATER DRINKING WATER

Survivor 06 (Model #8013418/#8013419)



Support is available by e-mail: techsupport@spectrawatermakers.com; or by phone 8:00a

(415) 526-2780

GB

DE

FRA

NL

DK

SWE

NOR

FIN

IT

ESP

POR

Key Components

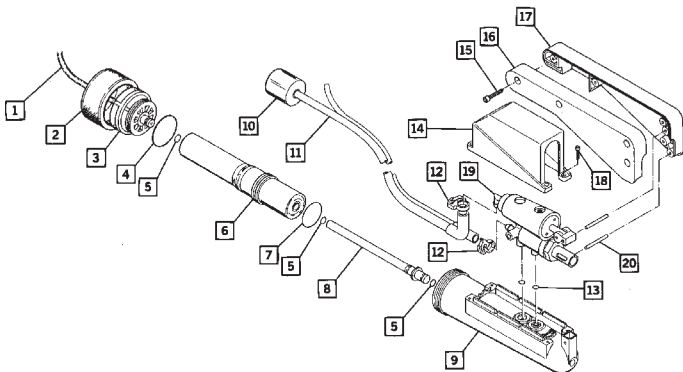

(Figure 1-2)

- | | |
|---|--|
| 1. Product Hose Kit (8013842) | 12. Clamps |
| 2. Cap membrane housing | 13. Two different O-rings and one seal |
| 3. End plug membrane housing | 14. Pump Body Cover |
| 4. O-ring | 15. Screw, handle (qty. 4) |
| 5. O-ring (qty: 4) | 16. Left handle |
| 6. Membrane kit (8013166) | 17. Right handle |
| 7. O-ring, brine seal already installed | 18. Screw, cover (qty: 4) |
| 8. Plug | 19. Pump Body |
| 9. Membrane Housing | 20. Handle pin (qty: 2) |
| 10. Weight and strainer | |
| 11. Hoses | |

Kits (not illustrated)

Support is available by e-mail: techsupport@spectrawatermakers.com; or by phone 8:00a

1. Membrane preservative 100 g bottle (8013327)

(415) 526-2780



MAKING WATER DRINKING WATER

Survivor 35 (Model #8013433)

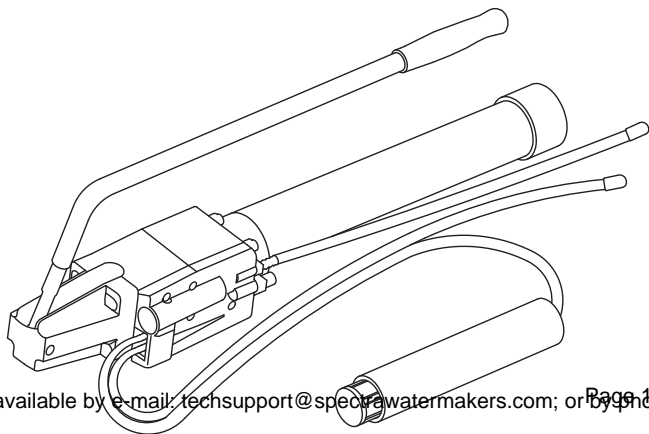

Support is available by e-mail: techsupport@spectrawatermakers.com; or by phone 8-000

(415) 526-2780

GB

DE

FRA

NL

DK

SWE

NOR

FIN

IT

ESP

POR

Key Components

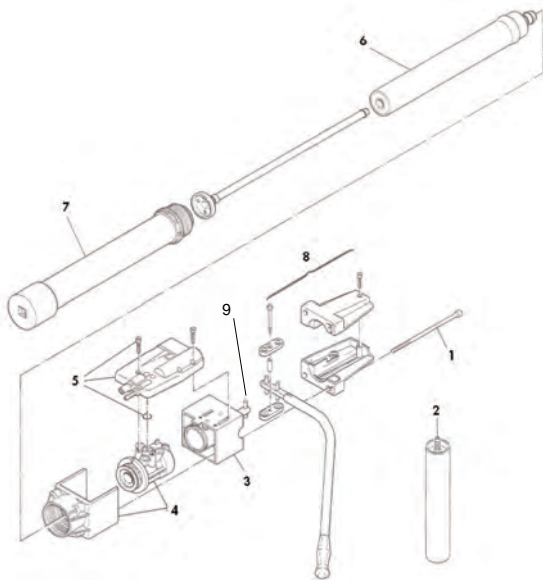

(Figure 1-3)

1. Capscrews (4 pcs.; 8013018)

2. Hose and strainer assembled

3. Pump Back

4. Pump Front

6. Membrane (8012793)

7. Membrane Housing

8. Handle (8012994)

9. Piston (8012970) No Seals, Order with Repair Seal Kit

Kits (not illustrated)

2. Repair Seal Kit (8013053)

(415) 526-2780

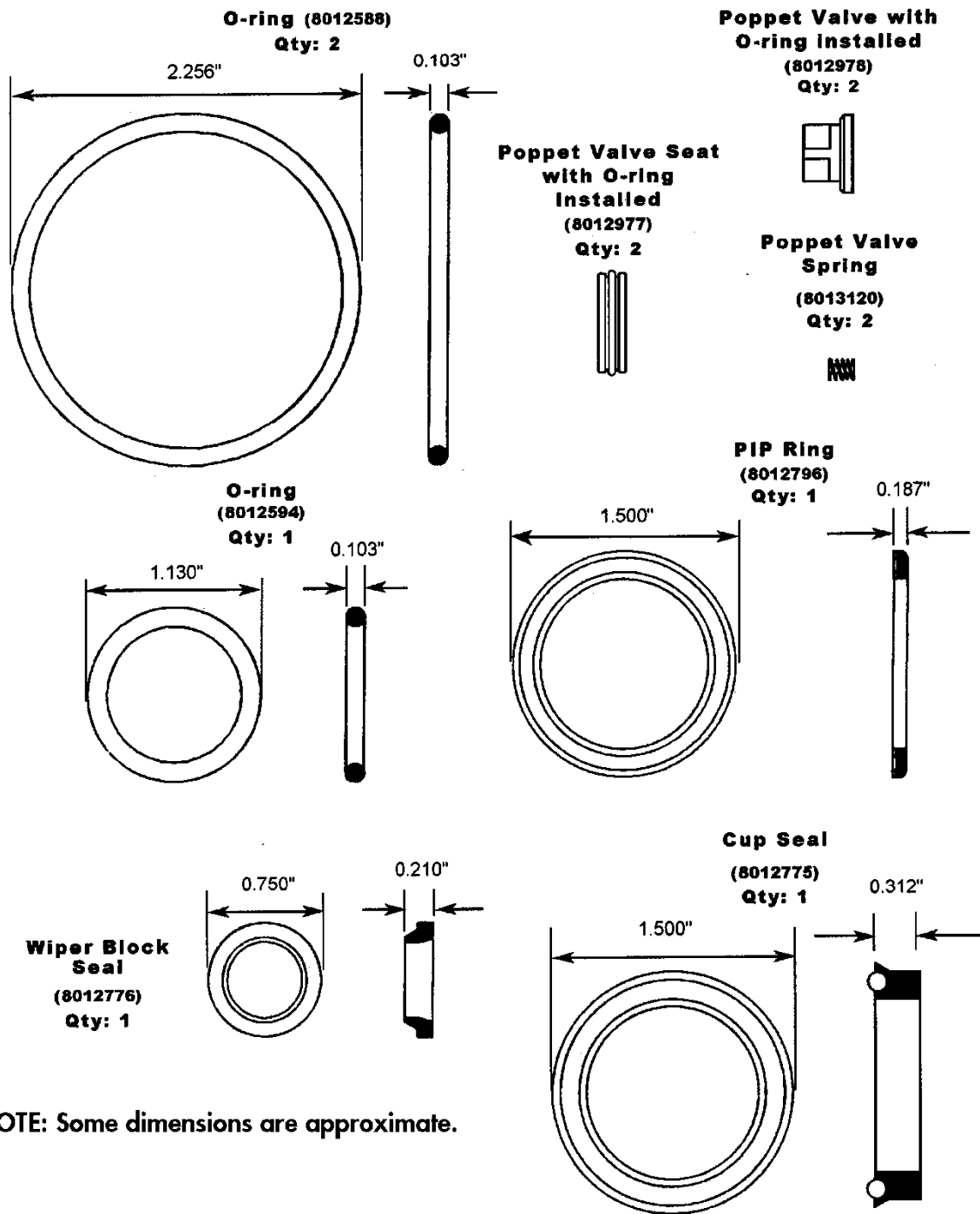

NOTE: Some dimensions are approximate.

Figure A-3

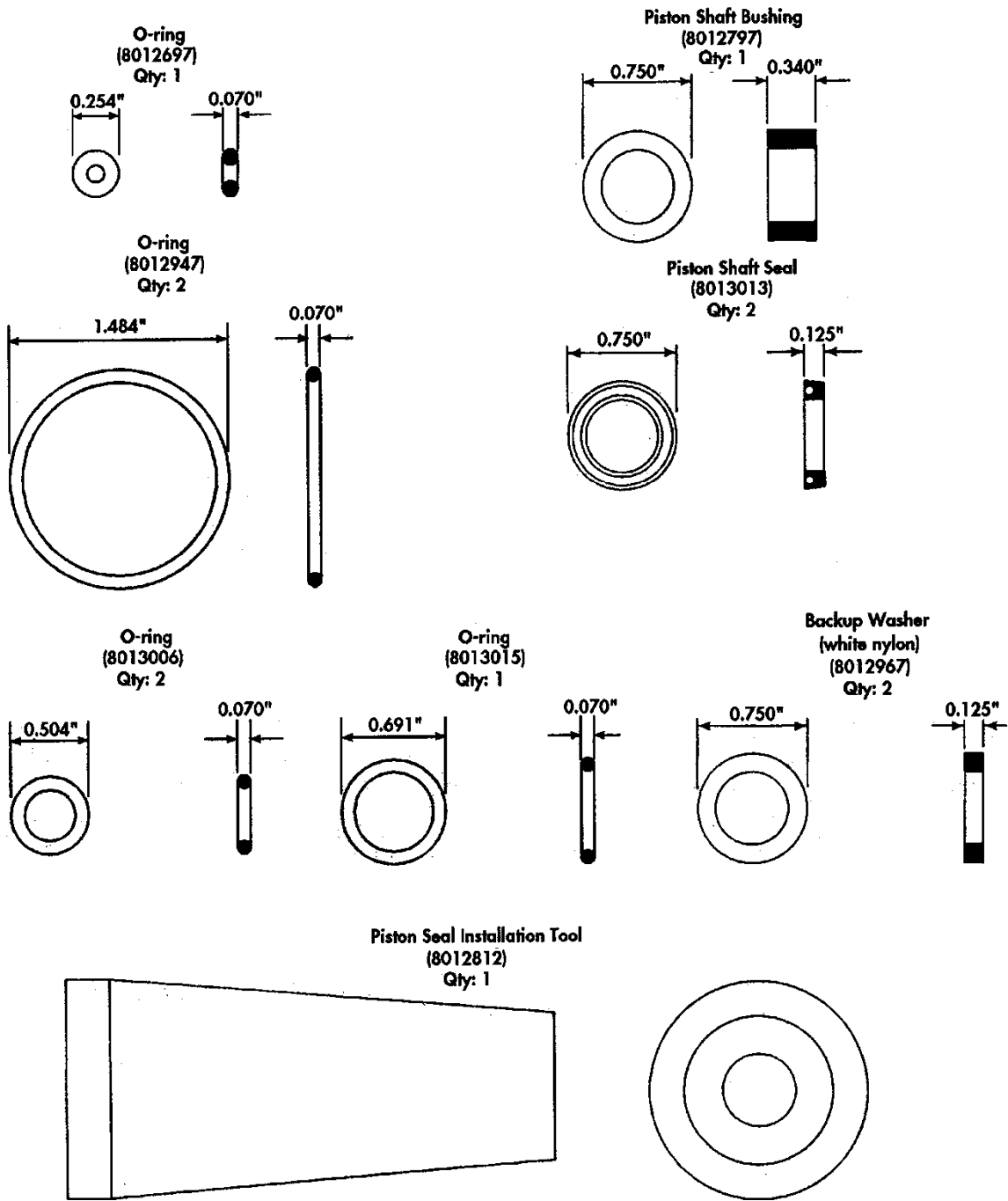

NOTE: Some dimensions are approximate.

Figure A-4

PowerSurvivor™ 80E 12-Volt & 24-Volt Watermakers



OWNER'S MANUAL

Figure A-1

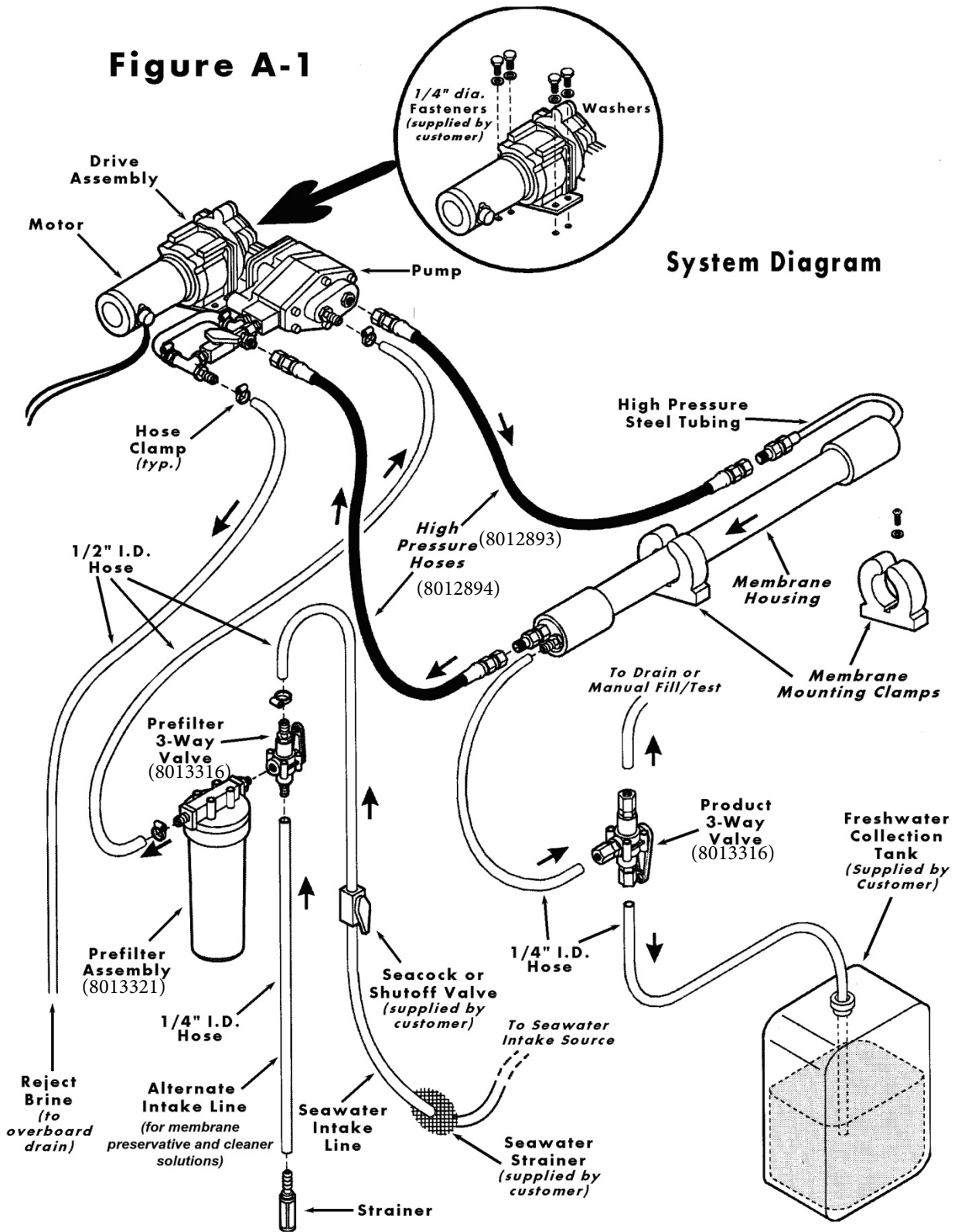

Pump Assembly Exploded Parts View

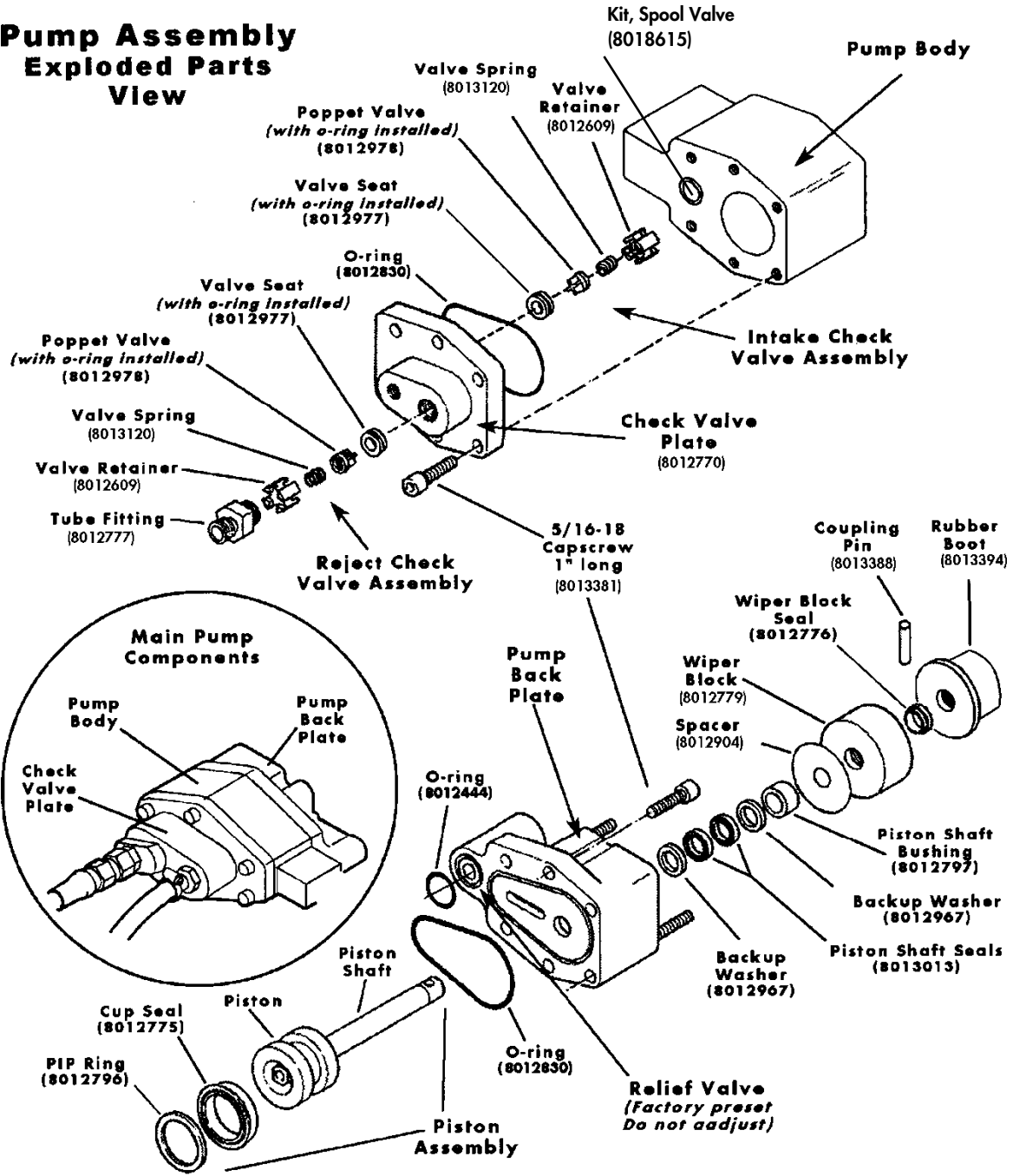

Figure A-2

**Poppet Valve Seat
with O-ring installed
(8012977)
Qty: 2**



**Poppet Valve
with O-ring installed
(8012978)
Qty: 2**



**O-ring
(8013008)
Qty: 1**

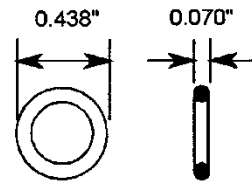

**Cup Seal
(8012775)
Qty: 1**

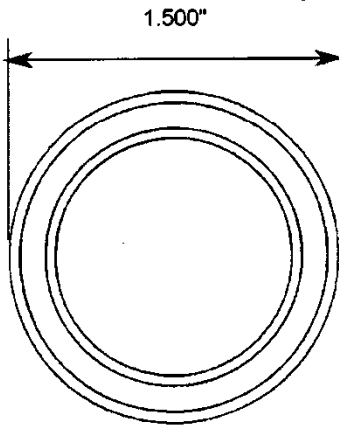

**PIP Ring
(8012796)
Qty: 1**

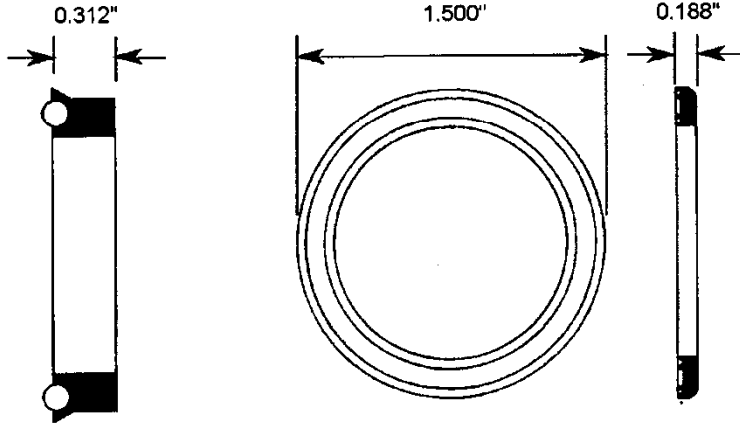

**Wiper Block Seal
(8012776)
Qty: 1**

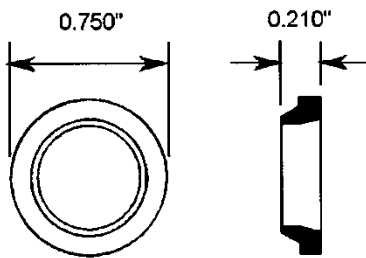

**O-ring
(8012830)
Qty: 2**

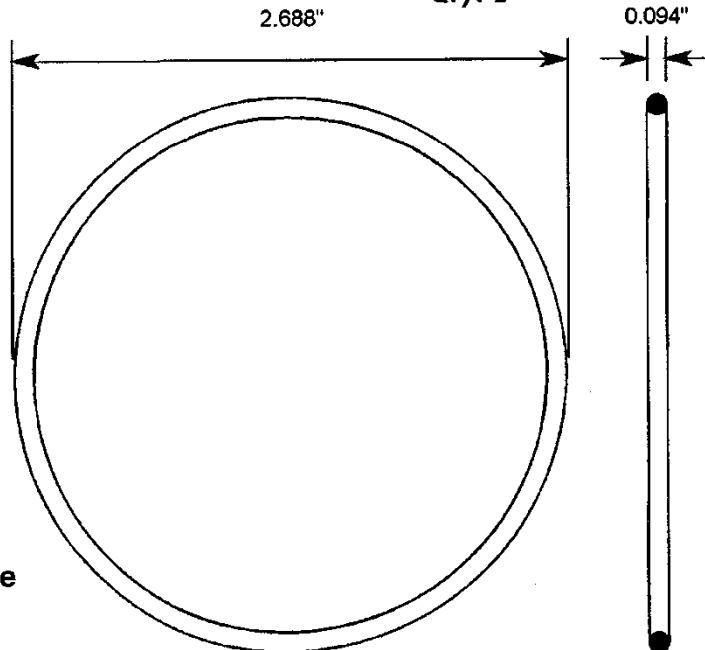
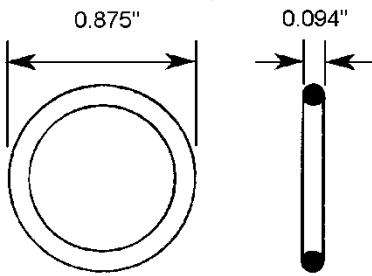

Figure A-3

NOTE: Some dimensions are approximate.

O-ring
(8012444)
Qty: 1



Piston Shaft Bushing
(8012797)
Qty: 1

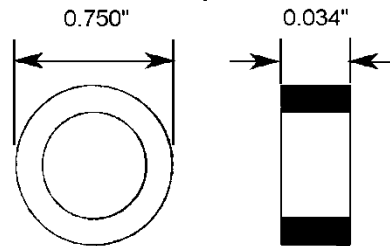

Backup Washer
(white nylon)
(8012967)
Qty: 2

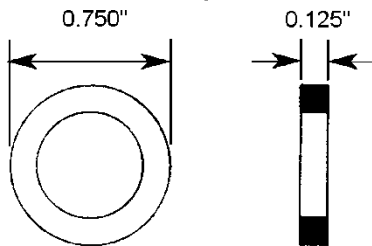

Piston Shaft Seal
(8013013)
Qty: 2

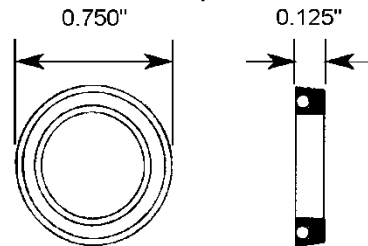

Poppet Valve Spring
(8013120)
Qty: 2



Repair Seal Kit
also includes
Silicone Lubricant

Piston Seal Installation Tool
(8012812)
Qty: 1

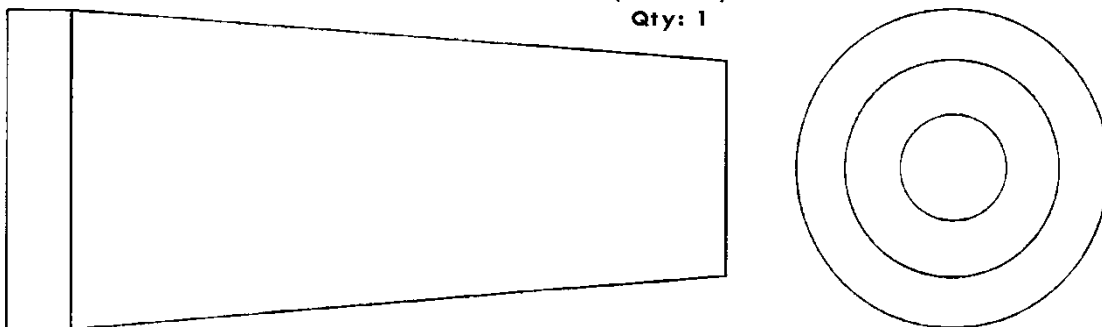

Figure A-4