



Ventura 150/200T MPC

Installation and Operating Manual



Spectra Watermakers
Katadyn Desalination LLC.
2220 S. McDowell Blvd. Petaluma, CA 94954
Phone: 415-526-2780 Fax: 415-526-2787
techsupport@spectrawatermakers.com

MPC Controller Quick Guide

To bypass the Purge Mode, **only if you are sure there are no chemicals in the system**, Press Auto Run and Stop, momentarily at the same time.

Program Mode allows checks and adjustments of all system settings. Please consult your manual before making any adjustments. See page 68.

Auto Run

To **Start** and run for **one hour**, press once. Press again for each additional hour of run time.

For **Auto Fill** mode, press and hold for 5 seconds and system will run until your **Tank Switch** closes.

Auto Run functions always terminate with a **fresh water flush**.

In **Program mode**, press to **REDUCE** value

Auto Store

Press and hold for 3 sec for **one time fresh water flush**

Press once to **fresh water flush** and activate the **flush timer interval**. The light blinks when in this timed flush mode.

In **Program mode**, press to **INCREASE** value



Stop (or Start)

Press once to start or stop system.

If you stop the system by pressing stop, the system **will not fresh water flush itself**.

Alarm Display

Push to silence alarm

When system is running, press to scroll through **system readings**

In **program mode**, push to scroll through the system parameters

Table of Contents

Installation	7
Getting Started	9
Introduction	10
Installation Basics	11
Ventura Plumbing Schematic.....	12
Product Water plumbing	13
Tube Fitting Assembly Procedures	14
Spectra High Pressure Fitting Instructions.....	15
Wiring	16
Salinity Probe Installation	18
MPC Tank Switch Wiring and operation.....	19
Optional Z-Ion and Z-Brane Membrane Protection Systems.....	21
Z-Ion Installation.....	22
Z-Ion Testing.....	24
Z Brane Installation.....	25
Operation	29
New Systems Start Up and Testing	31
Dry Testing with an Artificial Ocean	34
Normal Operation and Fresh Water Flush.....	35
Auto Store and Flush Cycle Adjustment	36
Alarm Override and Manual Operation.....	37
Maintenance, Storage, and Troubleshooting	39
Suggested Spares.....	41
Maintenance	42
Introduction to Spectra Chemicals	44
Long Term Storage Procedures	46
Winterizing with Propylene Glycol	47
Membrane Cleaning Procedure	48
Troubleshooting	49
Poor Water Quality.....	51
Ventura Flow Test	52
Technical Bulletins.....	54

Table of Contents continued...

MPC-5000 Programming & Controls.....61
Introduction..... 63
MPC 5000 Operation Guide 64
Display Controls 65
Programming from the Display 68
Salinity Probe Calibration 71
Wiring Schematic 72
MPC 5000 PCB Fuses and Electrical Specifications..... 73

Exploded Views and Part Numbers.....75

Installation

Getting Started

Unpack the system and inspect it for damage during shipping. Freight damage must be reported to the carrier within 24 hours.

Refer to the shipping list for your system to ensure you received all of the components listed. Do not discard any packaging until you have found and identified all of the parts. The small installation parts are listed on the kit list.

Warning! We will not be held responsible for shortages that are not reported within thirty days of the ship date.

Study the system layout diagram, component photos, and descriptions before beginning installation.

Lay out the system. Before starting the installation identify where each module and component will be placed. Ensure that there is enough clearance around the components for removal of filters and system service. Make sure you have adequate tubing and hose before starting. Additional parts may be ordered.

THE VENTURA 200T IS DESIGNED FOR WARM WATER USE. OPERATION IN WATERS BELOW 50° F (10° C) MAY CAUSE HIGH OPERATING PRESSURES AND INCREASED WEAR ON THE FEED PUMP.

Ventura 150-200T MPC Shipping List:

- Ventura MPC 5000 kit (includes control box and display)
- Accumulator Assembly with analogue gauge
- High pressure Clark Pump with membrane pressure vessel
- Black high pressure filter housings
- Feed pump assembly with fresh water flush module
- Ventura MPC install kit with black product water tubing
- Service kit
- Two lengths 5/8" Hose (25')

Optional: Z-Ion or Z-Brane system



Introduction to the Ventura MPC

The Ventura is the finest watermaker for small and midsize yachts. Properly installed and maintained it will supply years of reliable service. The MPC 5000 automatic control system adds programmability, automated operation, and system monitoring. Prudent operation is required with any marine equipment. ***Always maintain enough reserve water to get to your next port safely.***

The Spectra Intensifier, known as the Clark Pump, was introduced in 1997 and has been continually improved since. It is built of modern, non-corrosive composites and comes with a 20" high rejection membrane.

Front View

Quick disconnect fitting eases maintenance.



Pressure Relief Valve

Double rubber mounts to absorb vibration

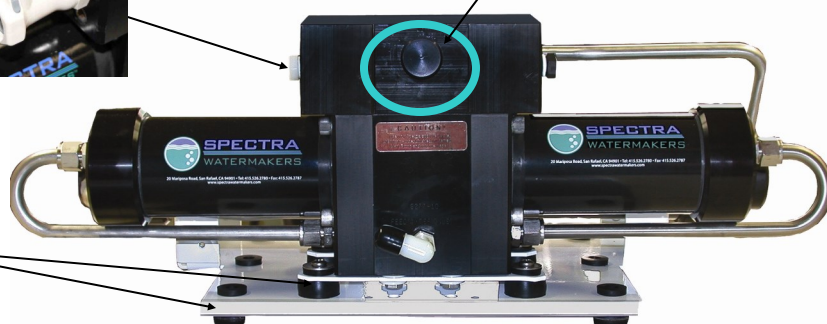

Rear View

The Clark Pump Membrane Module. Pre-mounted and plumbed together as a single unit. Saves time and adds reliability.

Fresh Water Flush Solenoid

Service Port

Service Valve

Fresh Water Filter Bowl with charcoal filter



Cooling Fan

Motor

Shurflo Pump Head

Ventura Feed Pump Module

Includes the feed pump, cooling fan, charcoal filter, flush valve, service valve, and service port. The module has compact and streamlined plumbing. The cooling fan is included for longevity.

IF YOU ORDERED YOUR SYSTEM WITH THE OPTIONAL Z-ION, IT WILL REPLACE THE FILTER BOWL ON THE FEED PUMP MODULE, AND HAVE AN ADDITIONAL CONTROL BOX. THE PHOTO ABOVE, AND ALL SUBSEQUENT PHOTOS OF THE FEED PUMP MODULE WILL LOOK SLIGHTLY DIFFERENT. SEE PAGES 21-24 FOR Z-ION INSTALLATION AND INSTRUCTIONS.

Installation Basics

- **Read the directions!**
- Avoid tight hose bends and excessive runs.
- Use heavy gauge wire.
- Install feed pump module as low as possible.
- Use a dedicated thru-hull with scoop type strainer.
- Do not mount components over electrical devices.
- **Avoid getting dirt or debris into the piping or hoses during assembly.** A small bit of debris can stop the system!

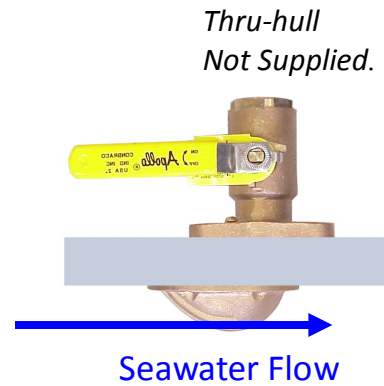

Thru-hull Location: The system must be connected to a dedicated 1/2" to 3/4" forward facing scoop-type intake thru-hull and seacock.

Install the thru-hull intake as far below the waterline and as close to centerline as possible to avoid contamination and air entering the system. Do not install the intake close to, or downstream of, a head discharge, behind the keel, stabilizer fins, or other underwater fixtures.

Thru-hulls in the bow area are susceptible to air intake in rough conditions. Sharing a thru-hull can introduce unforeseen problems such as intermittent flow restrictions, air bubbles, contaminants, and will void the warranty. For racing boats and high speed boats traveling above 15 knots, a retractable snorkel-type thru-hull fitting is preferred because it picks up water away from the hull.

The brine discharge thru-hull should be mounted above the waterline, along or just above the boot stripe, to minimize water lift and back pressure.

Double clamp all hose connections below the waterline.

Avoid restrictions or long runs on the entire inlet side of the plumbing from the thru-hull to the feed pump module.

Secure the piping away from moving objects such as engine belts and hatches. Prevent chafe on the tubing as required. Test and inspect all piping and hose clamps after several hours of operation.

Pipe Fitting Instructions: To seal plastic-to-plastic fittings, wrap 6 to 8 layers of Teflon tape over their threads. Hold the fitting in your left hand and tightly wrap the threads clockwise. For smoother assembly, do not tape the first (starting) threads.

Wiring

- Pay attention to wire size or system performance will be impaired
- Perform wiring to UL, ABYC, CE or applicable standards

Ventura MPC Plumbing



Brine Discharge thru-hull. Place above waterline or tee into another visible drain. Thru-hull not supplied

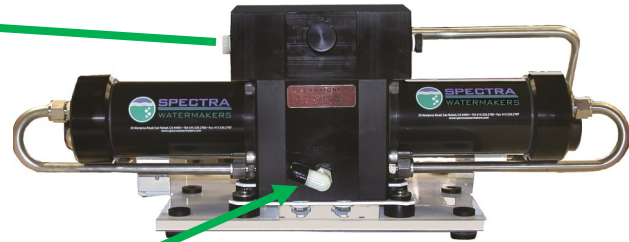

Spectra Clark Pump. Mount in a cool location. May be oriented in any position and can be well above waterline. Leave access to the pressure relief valve. Do not mount over electrical equipment. **Note:** Salinity probe must always be down (to stay wet), so you will need to reorient the diversion manifold if the module is mounted upside down.



MPC Control Box: Remember to mount in central location, where various cables can reach all components and the power supply.



Accumulator Tank with analogue feed pressure gauge

20 and 5 micron filters. Do not mount over electrical equipment. Leave clearance underneath for filter changes.

Fresh water flush inlet to charcoal filter. Plumb to pressurized side of onboard fresh water system. **Optional Z-ION will replace this filter housing.**

Red In Green Out



Sea Strainer: Mount with included Quick Block

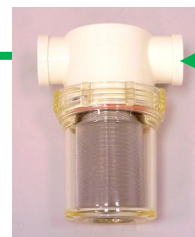

Feed Pump Module. Mount vertically and as low as practical, no more than 3' (1 M) above waterline. Do not mount over electrical equipment. Leave clearance below for filter changes.

Dedicated 1/2" or 3/4" scoop strainer thru-hull and sea-cock. Mount low, in a clear flow and away from head discharge. Thru-hull is owner supplied.



Water Flow →

Product Water Plumbing

The 1/4"(6mm) product water tubing is pre-plumbed from the membrane into the electric diversion valve. The diversion valve will reject product water into the overboard brine stream until MPC-5000 control determines the product water is below 750 PPM salinity. Once below 750 PPM, the MPC 5000 control opens the diversion valve and product water is diverted into the fresh water tank. For plumbing to the fresh water tank, **see the Parker tube fitting assembly diagram on next page.**

Product to tank: Route the product water into the top of a vented tank, or a tee in the water tank fill hose. **DO NOT** feed into a vent line, manifold, or into the bottom of the tank. Bladder tanks will create too much back pressure. There must be no restriction or back pressure whatsoever in this piping.

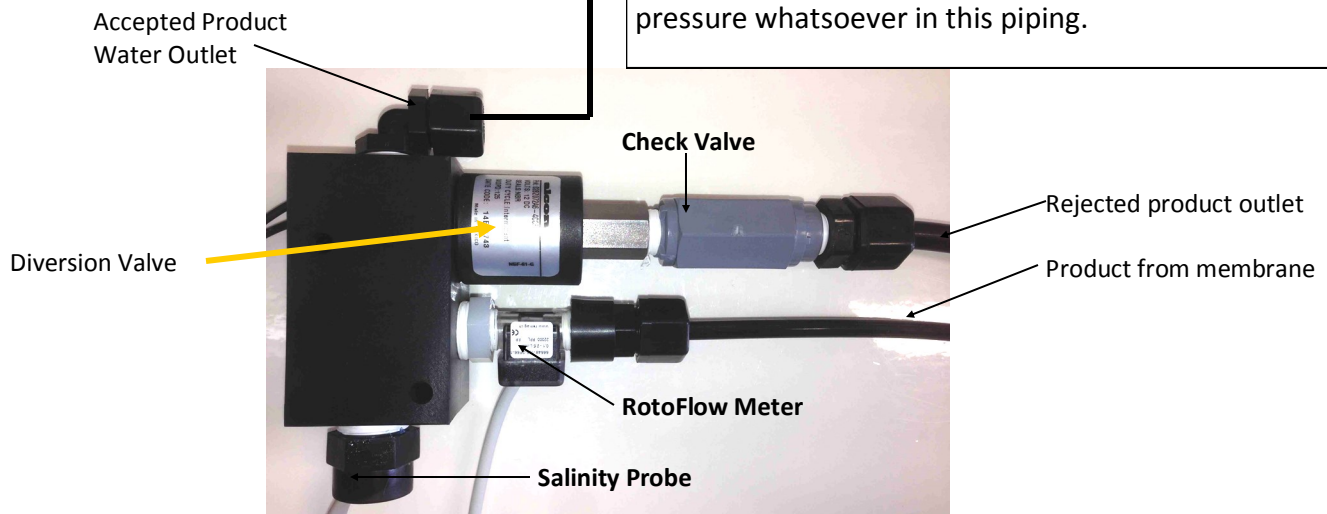

Product Diversion Valve Manifold

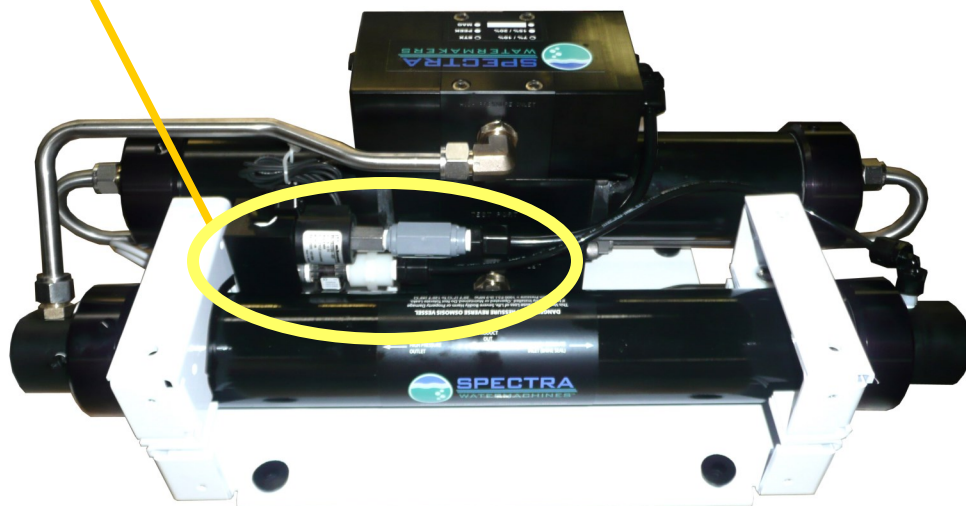

Fast & Tite® Thermoplastic Fittings

Fast & Tite® fittings are the most complete line of plastic fittings for thermoplastic tubing in the industry.

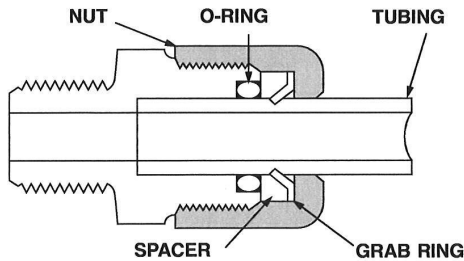

Fast & Tite® thermoplastic tube fittings from Parker will prove to be the answer to your tubing connector needs. Patented Fast & Tite® fittings install in seconds without tools and provide a tight, sure, leak proof seal without clamps or adjustments. A unique 302 stainless steel grab ring for tube retention, coupled with a Nitrile O-Ring for positive seal, assures good tube connection with only hand tight assembly. A plastic grab ring is also available upon special request. Vibration or tube movement will not break the seal and cause leakage. Preassembled in either highly inert polypropylene, or strong, durable nylon, Fast & Tite® fittings are the answer to full flow thermoplastic tubing system requirements.

When necessary, Fast & Tite® fittings can be disassembled by hand for fast system drainage. Fittings are completely reusable.

Parts are easily replaced. O-Rings are standard size and universally available. (For applications requiring other than Nitrile O-Rings, consult your Fast & Tite® distributor.)

Use Fast & Tite® fittings with Parker Parflex tubing or other plastic, glass or metal tubing for low pressure or vacuum lines up to the pressure limits shown below.

Fast & Tite® fittings meet FDA and NSF-51 requirements for food contact.

Working Pressures for Fast & Tite® Fittings

Tube O. D., in.	Air-Oil-Water Pressure in PSI		
	Up to 75°F	76° to 125°F	126° to 175°F
1/4	300	300	300
5/16	300	300	300
3/8	250	250	150
1/2	200	200	150
5/8	150	100	50

Ratings are based on use with copper tubing, and in all cases represent the maximum recommended working pressure of the fitting only. Working pressures (vs. temperatures) of other types of tubing may limit the tube and fitting assembly to pressures lower than shown above. Consult factory for recommendations on applications other than shown above.

Temperature Range:

Black/White Polypropylene: 0°F (-18°C) to +212°F (+100°C)
 White Nylon: -40°F (-40°C) to +200°F (+93°C)

Fast Assembly

Step 1.

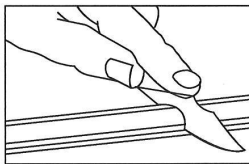

Cut the tube squarely and remove any burrs.

Step 2.

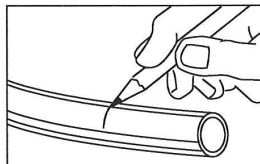

Mark from end of tube the length of insertion. (See table below)

Tube O.D. (in.)	Insertion Length with Tube Support (in.)	Insertion Length without Tube Support (in.)
1/4	5/8	9/16
5/16	5/8	9/16
3/8	13/16	3/4
1/2	7/8	13/16
5/8	1	15/16

Step 3.

Loosen nut on fitting until three threads are visible. Fittings for glass tubes must be disassembled and the grab ring removed.

Step 4.

Moisten end of the tube with water. Push the tube **Straight** into fitting until it bottoms on the fitting's shoulder. Tighten nut by hand. Additional tightening should not be necessary, but 1/4 additional turn may be added if desired. **Do not overtighten** nut as the threads will strip and the fitting will not function properly. A proper assembly will not show the insertion mark extending beyond the nut. If the insertion mark is visible, then steps 1 thru 4 must be repeated.

Step 5.

When using clear vinyl tubing or urethane tubing, it is necessary to use a **TS** tube support. Disassemble the fitting and place the nut, grab ring, spacer and tube support, in that order on the tube. Locate the grab ring at the insertion mark as shown. Seat the O-ring in the body, then proceed with Step 4.

Note: Provide adequate fail-safe mechanisms such as leakage detection sensors, automatic shut-off controls or other industry and code appropriate fail-safe devices in the design of your water-handling appliance to protect against personal injury and property damage.

Plastic fittings containing an o-ring that are used in water applications should be replaced at least every five years or more frequently depending on the environment and severity of the application.

Spectra High Pressure Tube Fitting Assembly Instructions

The Ventura Deluxe has eight high pressure fittings, two on each cylinder on the Clark Pump, two on the pressure vessel end caps, and two 90-degree elbows on the back of the Clark Pump. As the compression fitting is tightened, it compresses a ferrule onto the stainless tubing, fixing the ferrule permanently to the tube and holding the compression nut captive.

The body of the fitting seals to the underlying component with an O-ring. On the Clark Pump cylinders and the end caps this O-ring is compressed by tightening the entire fitting. The O-rings on the 90-degree fittings on the back of the Clark Pump have captive nuts and washers, which compress the O-rings without turning the entire fitting.

If a tube fitting leaks it can sometimes be resealed by just tightening. You must use two wrenches, a 13/16-inch wrench to hold the base, and a 7/8-inch wrench to turn the compression nut. The 13/16-inch wrench will need to be thin so as not to interfere with the compression nut. If this doesn't work, disassemble the fitting, grease liberally with silicone grease (the ferrule and the threads) and re-tighten firmly.

The base O-rings should be **gently** compressed to achieve a good seal, and may be damaged by overtightening.

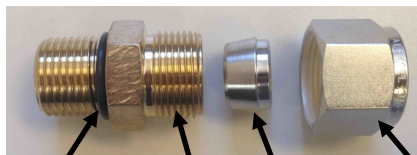

Connector O-RING

Nickel-Bronze High Pressure Straight Fitting

Ferrule

Stainless Fitting Hex Nut



Nickel-Bronze High Pressure Elbow

Wiring

Mount the control box with 4 appropriate fasteners on a vertical surface, above components containing water, with the wire grommets down, and central to the other system components. Make sure the cables will reach all of the modules to avoid splices. The main power feed should come from an appropriately-sized fuse or breaker on the main DC panel. See wire size and fuse/breaker tables below.

Warning! Do not connect the main power feed until all other connections are made.

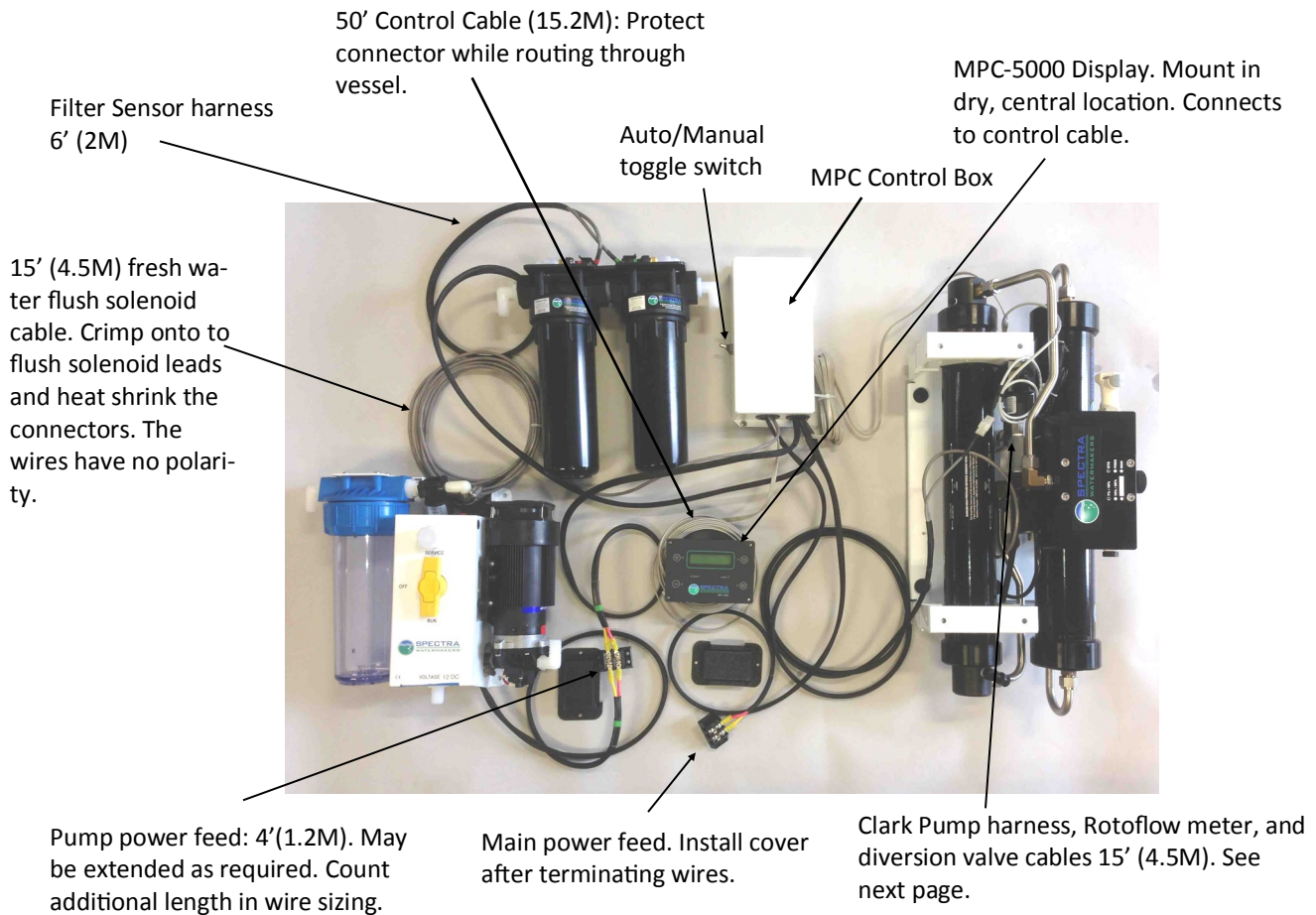

Wire Size Guide for the Ventura 12V:

Protect with 15 Amp Fuse or Circuit Breaker

10 Gauge (5mm²) up to 15 feet (4.5M)

8 Gauge (8mm²) up to 25 feet (7.5M)

6 Gauge (13mm²) up to 35 feet (10.6M)

Wire Size Guide for the Ventura 24V:

Protect with 7 Amp Fuse or Circuit Breaker

10 Gauge (5mm²) up to 25 feet (7.6M)

8 Gauge (8mm²) up to 35 feet (10.6M)

Distances at left represent the total ROUND TRIP wire length (DC positive length plus DC negative length), NOT the length of the pair of wires together. Size cables accordingly.

Wiring continued...

Mount the terminal block from the feed pump and attach the **pump power wires** coming from the MPC control box. Both wire bundles are marked with green heat shrink tubing.

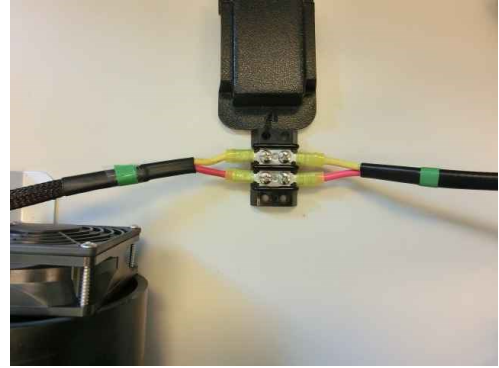

Run the **pressure sensor cables** from the MPC control box to the filter housings. The cables are marked red and green, to connect to their corresponding sensors.



Fresh water flush solenoid (two black wires, no polarity):

Connect the **fresh water flush cable** to the fresh water flush solenoid. Crimp the attached heat shrink butt connectors onto the two black wires coming from the solenoid. There is no polarity. The fresh water flush cable can be distinguished from the diversion valve cable, both of which are gray cables with butt connectors on their individual wires. The diversion valve cable is run in a bundle with the rotoflow cable, while the fresh water flush solenoid cable runs by itself from the MPC control box.



Fresh water flush cable from MPC box:

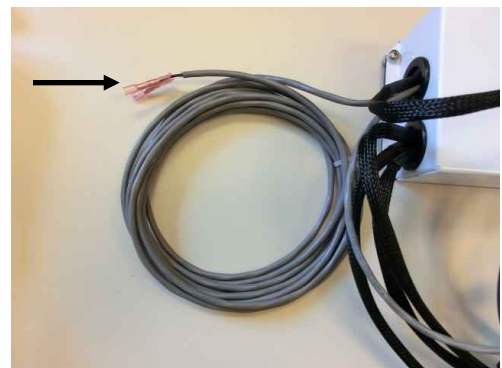

Wiring continued...

Rotoflow and Diversion Valve: The Rotoflow meter measures product flow, and is supplied with a three-pin plug-in connector. Plug it in to the Rotoflow cable and seal the connection with the supplied heat shrink tubing.

The diversion valve cable has two wires with no polarity, so they can be connected either way. Crimp the supplied heat shrink butt connectors to the diversion valve leads and heat them to seal. (See photo of diversion valve assembly on page 13.)

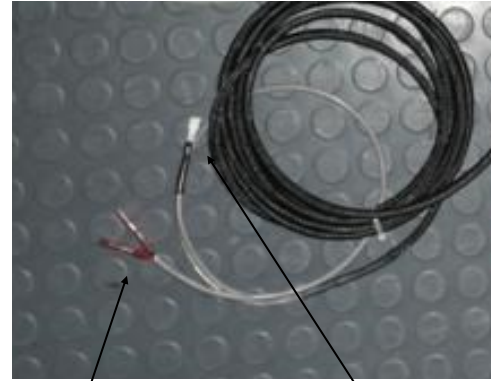

To Diversion Valve

To Rotoflow Meter

Remote Display Panel: The remote panel can be mounted anywhere dry and convenient. Cut a 4-1/2" (116 mm) wide by 2-7/8" (73mm) high opening for the panel.



Salinity Probe and Display Cables: The salinity probe cable is hard-wired directly to the probe in the potting compound, and cannot be removed.

Secure the salinity cable to the wiring bundle with the rotoflow and diversion valve wire harness, leaving enough loose cable for a service loop. Plug the salinity probe connector into the jack marked "Salinity" on the MPC box.

Route the display cable from the display to the jack marked "display." **Use only a Spectra-approved cable.** The cable is not a standard LAN cable or phone cord.

RJ-12 Connector



Take care not to damage the plugs on the ends of the cable when routing. Slip the protective boots over the connectors to waterproof them.

Insert RJ-12 connectors into jacks:



Slip waterproof boots over connectors:



MPC 5000 Tank Switch Installation and Operation

By installing a float switch at the top of your water tank, the watermaker can shut itself down and fresh water flush itself when the tank is full.

Automatic operation using a float switch could potentially flood a boat or run ship's batteries completely dead, so it is imperative that you have a thorough understanding of the automatic operation, and your ship's plumbing and electrical systems. Contact Spectra for more information.

If the tank remains full for extended periods, the watermaker will automatically fresh water flush itself, as programmed under the Flush Interval (see pages 36 and 68).

The float switch is connected to terminals on the green 10 pin connector on the MPC circuit board, labeled **Float Switch 1**. There is no polarity. **Float Switch 2** is for land-based applications only, and will be bridged with a jumper wire in marine installations. See the wiring diagram on the next page.

Spectra uses two types of float switch, the side-mounted float switch (EL-SWT-SMLV) and the top-mounted Tank Full Switch (EL-SWT-LV). Either may be used, depending on the geometry of your tank.

To use this mode the watermaker must be started with the **Stop/Start** button or the **Auto Run** button. The watermaker will then fill the tank automatically and enter the Autoflush Mode, fresh water flushing itself according to the programmed Flush Interval.

If you are using the tank full switch, DO NOT press and hold the Auto Run button, as this will enter the AutoFill Mode and the watermaker will not function properly.

Note: It is possible to have tanks switches on multiple tanks. Contact Spectra factory for advice.

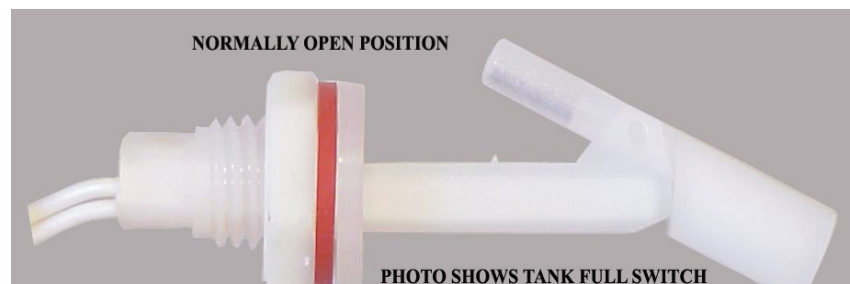

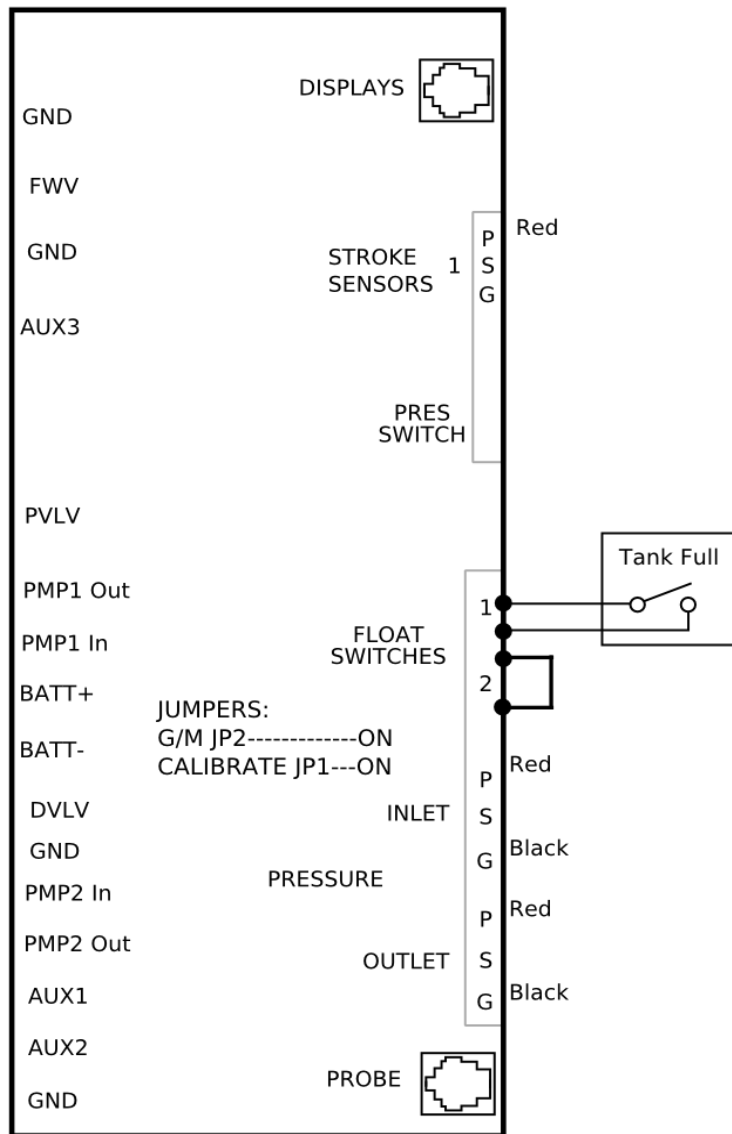

MPC 5000

Tank Switch Wiring: Tank full switch wired to Float Switch 1 terminals; jumper across Float Switch 2 terminals

Optional Z-Ion and Z-Brane Membrane Protection Systems

The Z-Ion and Z-Brane, both developed by Spectra, are systems to protect the reverse osmosis membrane from fouling for extended periods without fresh water flushing or storage chemicals (pickling).

The Z-Ion achieves this end by introducing a stream of metallic ions into the fresh water flush module, thus flooding the entire system with ions that prevent biological growth for up to thirty days. If you are going to let your system sit idle for longer than thirty days, treatment with SC-1 storage chemical or propylene glycol is still required.

The Z-Brane applies zeta potential high voltage capacitive current to the membrane pressure vessel, creating an unfriendly environment for bio-film and bacteria, and assists in the prevention of scale formation on the membrane surfaces. After thoroughly fresh water flushing the system, the Z-Brane will protect an idle system indefinitely as long as the Z-Brane is energized. The Z-Brane draws less than 1 Amp, but storage with chemicals may be preferable for longer periods if battery power is an issue.

Neither the Z-Ion nor the Z-Brane will prevent freezing, so in freezing climates pickling with propylene glycol is still required. Even with the Z-Ion or Z-Brane there may still be cases where you need to pickle your system with SC-1 storage chemical or propylene glycol, so we recommend you carry one of these products at all times.

If your system was ordered with either of these systems, they will require only some basic wiring and commissioning, laid out in the following pages.

If you didn't order your system with the Z-Ion or Z-Brane, either can be retrofitted to any Spectra system.

Z-Ion Installation

The Z-Ion replaces the fresh water flush module on the feed pump module, and will come installed if you ordered your system with the optional Z-Ion. The Z-Ion filter bowl, like the normal fresh water flush module, houses the charcoal filter, which must be replaced every six months.

The Z-Ion control box comes with four-foot cables for flexibility in mounting on the bulkhead above or adjacent to the feed pump module.

Plug the connector from the Z-Ion generator bowl into the connector from the Z-Ion control box.

Connect the power/signal cable, marked green, from the Z-Ion control box to the Z-Ion control cable, also marked green, coming from the MPC box.

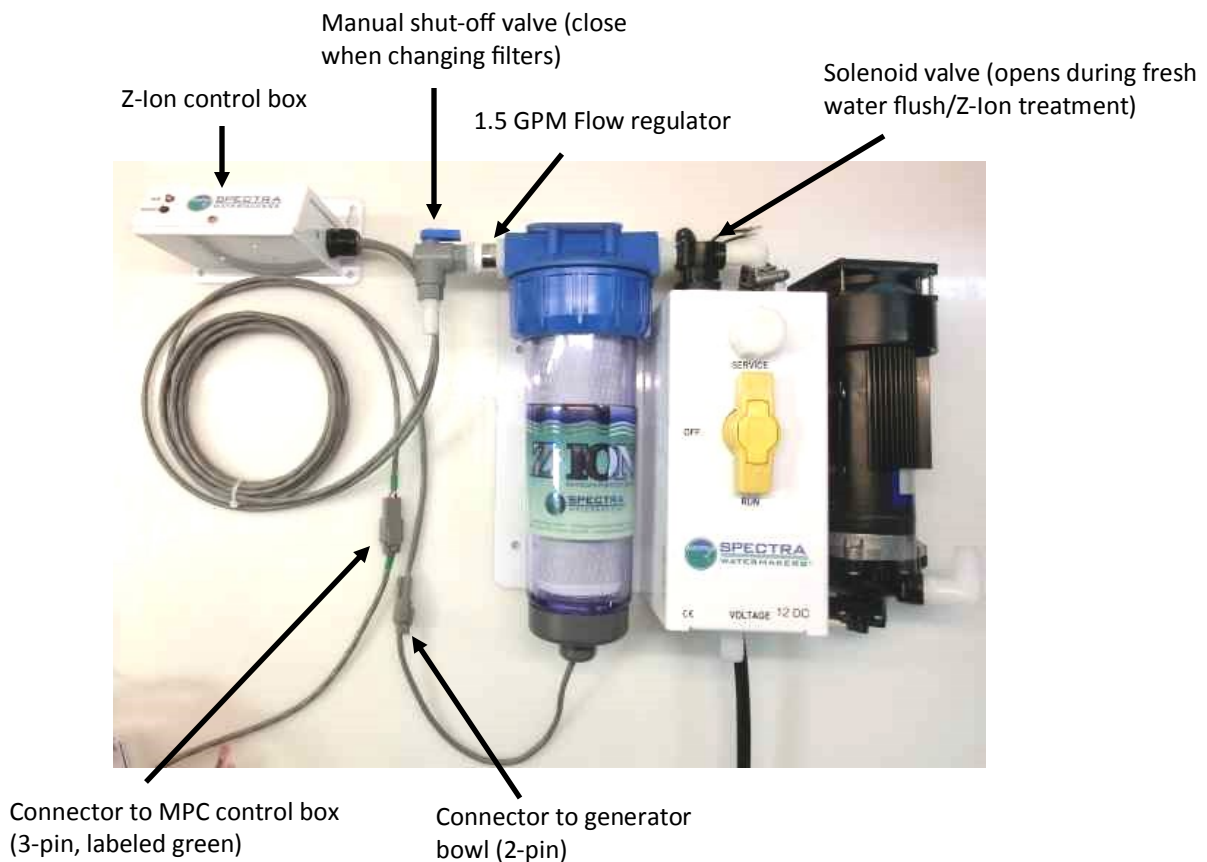

Z-Ion Operation

This revolutionary adaptation of an ancient technology effectively and safely protects the membrane and filters on your Spectra Watermaker. Your system will be kept ready to operate without any additional flushing, external power sources, pickling chemicals, or complex procedures.

The Z-Ion should be energized at all times, but will only consume power when water is running through it. Upon initial power-up the LED will flash red/green and then will turn solid green.

Follow the instructions on page 35 for Normal Operation and Fresh Water Flush. For treatment with the Z-Ion, the process is identical, only the Z-Ion will release silver and copper ions into the flush water.

When fresh water flows, the operation cycle begins and the LED will flash green/amber. The cycle will continue until either the water flow stops or the adjustable timer times out (factory set for 15 minutes).

If the voltage is out of range, below 10V or above 56V, the LED will flash red every two seconds and the unit will shut down.

Each fresh water flush with the Z-Ion will protect your watermaker for up to 30 days, after which the process must be repeated.

After 720 cycles the service light on the front of the control box will light up, indicating that the probes on your Z-Ion may be wearing down, and should be tested. The service light is just a reminder, and the Z-Ion will go on functioning while it is lit. For testing procedures, see the next page.

To reset the service counter, touch two magnets, at the same time, to the two red reed switches on the Z-Ion circuit board, labeled Switch 1 and Switch 2 below.

Z-Ion Circuit Board Layout

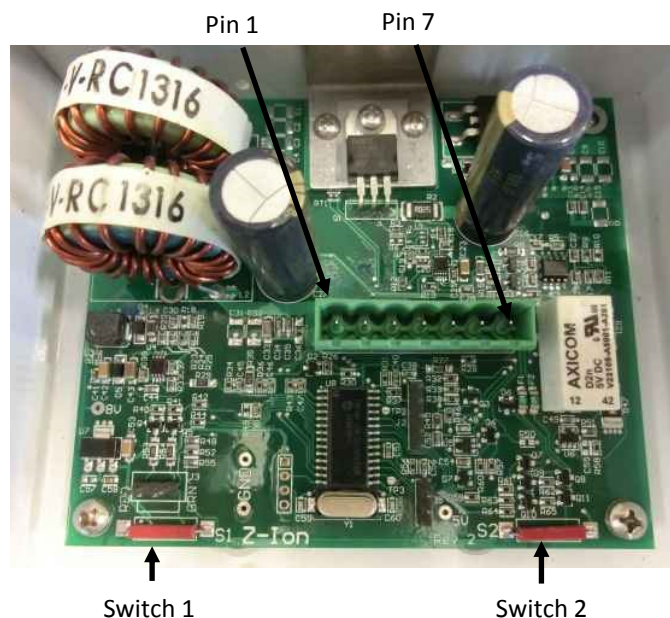

Testing the Z-Ion

Normally no adjustment is necessary as the unit has been set up at the factory for your water-maker, however it is advisable to make sure the Z-Ion is working properly. Likewise, the following test is the only way to know if the probes on the Z-Ion need replacement.

There is no way to test for silver ions, but we can test for copper ions. The Z-Ion puts both into the flush water, and where there is one there is the other. You will need Spectra test kit (EL-ZION-TESTKIT) or a similar copper test kit for pools and spas.

Once the installation is complete and the unit is powered up, carry out a fresh water flush per the instructions on page 43. The LED on the Z-ION controller should flash as the unit cycles. Close to the end of the flush cycle, take a sample of the brine discharge. If the brine discharge thru-hull isn't accessible you will need take a sample from the brine outlet on the Clark Pump, or use the brine discharge service hose. Once you have obtained a sample, first check it with a salinity meter to make sure the salinity is below 1000 PPM. Next, use the copper test kit to make sure the flush water contains between .5 and 1 Parts Per Million of copper.

Note: A new carbon filter will sometimes absorb some of the copper ions, causing a copper test to read low. Samples should be taken after a new carbon filter has been wet for a few days.

If the flush water does not have adequate copper content then please contact our technical support for instructions on how to adjust the system.

Copper test kit:



Z-Brane Installation

Spectra ships the high pressure module with the white Z-Brane anode removed from its socket to prevent shipping damage. Before the high pressure module (Clark Pump and membrane) is mounted the anode should be installed.

The membrane housing has been capped with shipping plugs to keep the membranes clean and moist during shipping and storage. Remove the C-clips that secure the shipping plugs, then remove the shipping plugs. Insert an anode into the membrane until the groove is flush with the membrane end plug. The C-clip will then slip into the groove, and the C-clip screw will secure the clip.

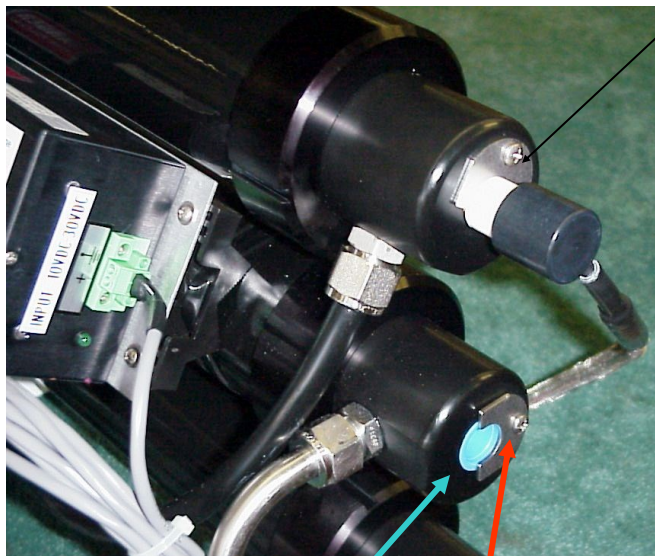

Shipping Plug (remove to insert probe) C Clip

C-Clip and retaining screw with probe installed



C-Clip groove in Anode

NOTE: your watermaker will only have one membrane. In these pictures there are three membranes.

Z-Brane Wiring

The Z-Brane system is integrated with the watermaker and only requires continuous 12V or 24V DC power to operate.

WARNING! SHOCK HAZARD!: There is no reason to open the transformer enclosure. Do not service this unit unless it is disconnected from the power source! There may be high voltage present even after the transformer is de-powered!

We recommend that the Z-Brane be connected to its own electrical circuit. The power must be on when the watermaker is in operation and when the Z-Brane is used for membrane storage. If the power is obtained from the MPC circuit board then the MPC must be powered up at all times during storage, and this may not be ideal.

Fuse the power at the source with a 1 amp fuse or circuit breaker.

Red is Positive (+) , Black is Ground (-)

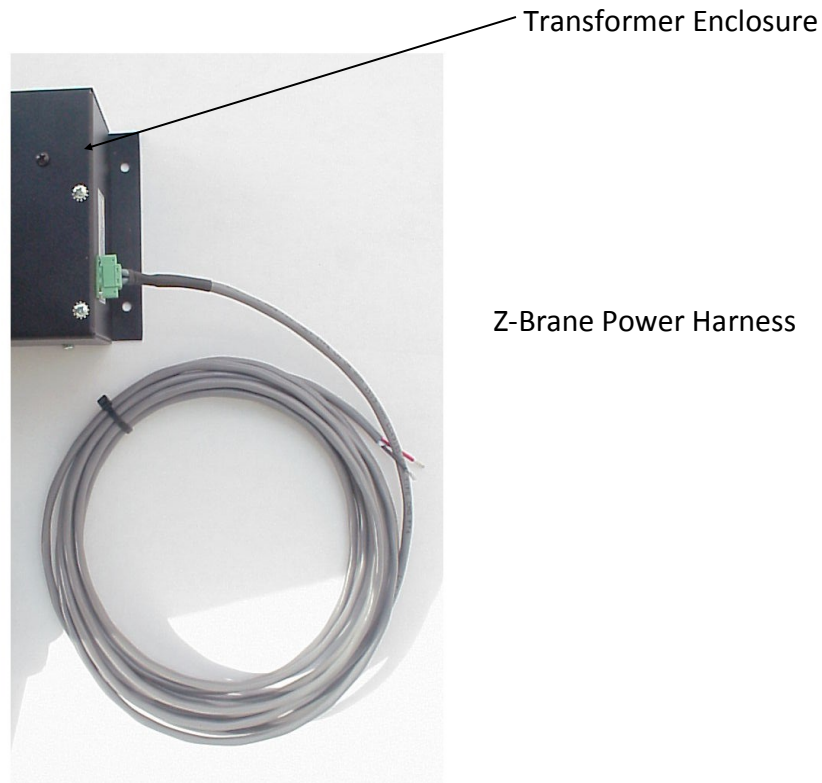

Z-Brane Operation

During normal operation the Red LED should be on. Power needs to be supplied to the Z-Brane unit whenever you wish to prevent bio-fouling and scaling. We recommend flushing your watermaker with fresh water after each use, which will protect your membrane and also prevent corrosion in the feed water system. Thoroughly fresh water flush the water-maker several times before leaving the vessel unattended for extended periods.

The Z-Brane may be de-powered if the system is pickled with chemicals or winterized with propylene glycol.

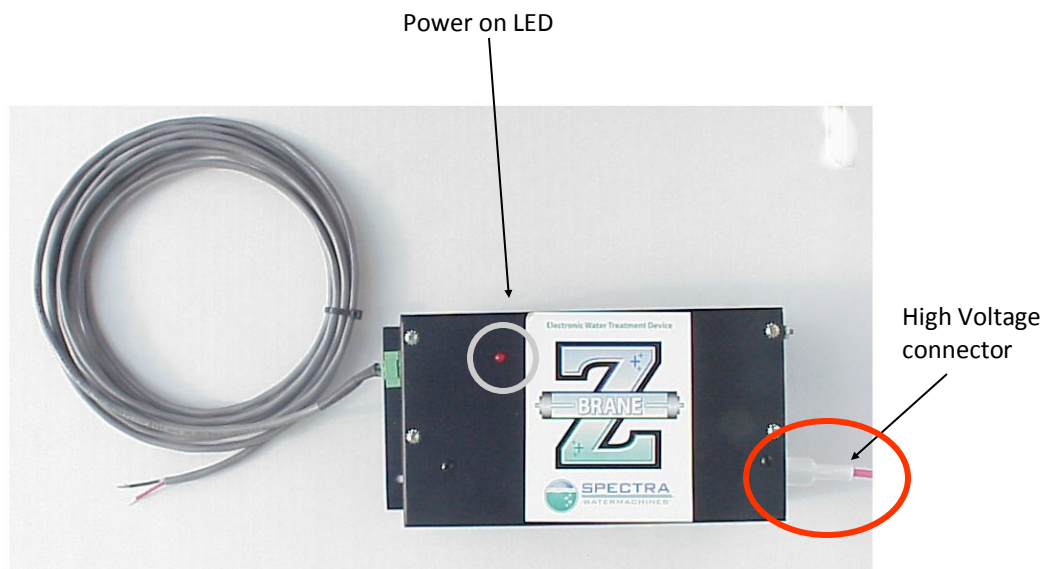

DO NOT DISCONNECT OR SPLICE ANY OF THE HIGH VOLTAGE WIRING!

Contact the factory if modifications are required.

Operation

New System Start-Up and Testing

Avoid running the Ventura system if the vessel is in contaminated water. The system should be fully tested before leaving port. If the location or weather prevents proper testing, refer to **Dry Testing with an Artificial Ocean** on page 34.

Warning! Damage may occur if the purge sequence is bypassed and the membrane is pressurized with storage chemical in it.

First check:

- Thru-hull inlet and the brine discharge valves are open.
- All of your hose connections are tight.
- The washer with the green tag under the pressure relief valve has been removed.
- The pressure relief valve is open 1/2 turn.
- The toggle switch on the MPC control box is set to the Auto position.
- There are at least several gallons of water in your fresh water tank for priming.

Remove Tag and Washer!

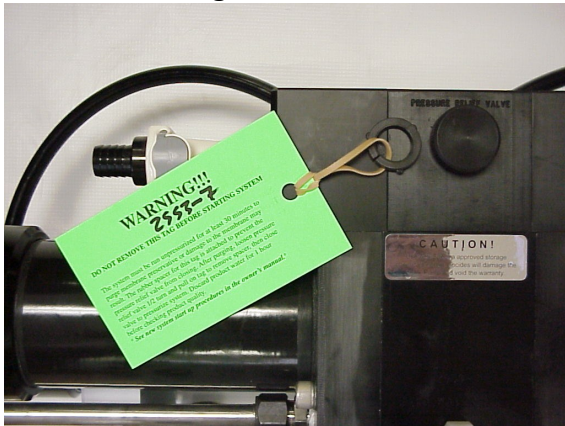

Open 1/2 Turn when purging chemicals!

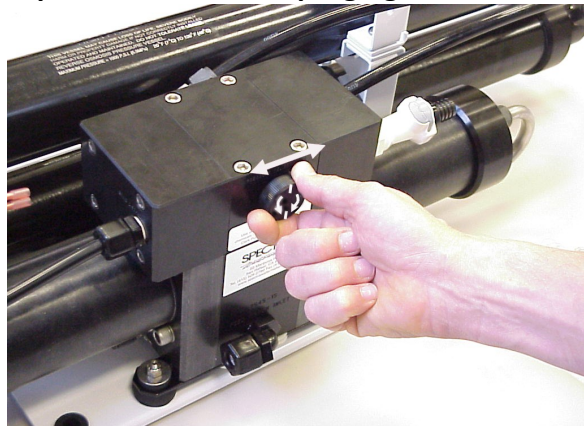

Power up the system by turning on the circuit breaker. After a few seconds a message on the display will read **“Open Pressure Relief Valve Now”**:



Push the **Auto Run** Button. The feed pump will start and the message **“Purging Storage Solution”** will appear:



New System Start-Up and Testing continued...

The system will go into a starting mode and the feed pump will start shortly thereafter. The fresh water flush solenoid will open, allowing water from your pressurized fresh water system to help prime the pump. The system should prime within 30-90 seconds. Check the strainer and the brine discharge for water flow. There should be few bubbles anywhere in the intake hoses and the feed pump should sound smooth after priming. After confirming that the system is primed, inspect for leaks.

Note: The reject light will be on whenever the product water is being rejected or not being made. When the product water is below 750 PPM the green (Good) light will show that water is going to the tank.



Note: You can bypass the purge sequence and initiate a normal start at any time by Pressing “Auto Run” and “Stop” simultaneously. This will bypass the purge sequence and enable a normal start. If you must stop the purge sequence for any reason, the control will default back to the beginning of the purging mode to protect your system. Be sure to purge the system of chemicals for at least twenty minutes. **DO NOT BYPASS THE PURGE MODE UNLESS YOU ARE ABSOLUTELY SURE THAT THE CHEMICALS ARE PURGED FROM THE SYSTEM, OR YOU WILL PERMANENTLY DAMAGE THE MEMBRANE.**

1. After the purge sequence, the control will alarm with the message “Close Pressure Relief Valve.” Close the valve and proceed by pressing **Auto Run**. **If the system has been preserved with propylene glycol**, flip the toggle switch to RUN MANUAL and run the system with the PRESSURE RELIEF VALVE OPEN for 4-6 hours to purge the propylene glycol (see pages 44-45).
2. The system is now running under pressure and making water. The display will read “PURGING PRODUCT WATER,” and count down another ten minutes while it purges any residual chemicals from the membrane and product lines. After ten minutes, if product water is below 750 PPM it will send the product water to the tank. Carefully inspect for leaks over the entire system. Shut down the system and repair any leaks you find.
3. The system is now operational, and you may run your system as you desire. When beginning to make water it is best to use the **Auto Run** button which defaults to the automatic fresh water flush after the unit is finished making water. If you shut down the system by pressing the **Stop** button the system will not fresh water flush. If you do stop the system using the **Stop** button, use the **Auto Store** button to effect a fresh water flush. You should fresh water flush your watermaker after every use.
4. Check that the system is operating within its normal parameters. Compare with the parameters on the next page.

MPC Display Modes

(Scroll through the modes with the Alarm Display key.)

Product

The Ventura 150 produces 6-6.5 Gallons Per Hour (GPH) or 26—27 Liters Per Hour (LPH) of product (fresh) water.

The Ventura 200T produces 7.7-8.5 GPH (29—32LPH)



Salinity

Salinity readout displays the conductivity of the product water in parts per million (PPM). Anything below 750 PPM is considered potable, and will be diverted to the tanks.



Feed Pressure

Ventura 150 feed water pressure range is 60—70 PSI (4.2—5 BAR)

Ventura 200T feed water pressure range is 80—90 PSI (5.5—6.2 BAR)



Filter Condition

When filters become partially clogged, the empty blocks on the bar graph on the MPC-5000 will gradually fill in. If the filters become fully clogged (all squares highlighted) the unit will shut off automatically and alarm "Service Prefilters."



Dry Testing with an Artificial Ocean

If it is not possible to test run the system with the boat in the water, you may test the system with an artificial ocean. You will need 1.3 lbs. of non-iodized salt (rock salt, sea salt, or aquarium salt) to make a 5 gallon (605 grams of salt per 20 liters) of water that is about 33,000 PPM salinity (average seawater salinity). A rule of thumb is 1/2 cup (.12 liters) of salt per gallon (4 liters) of water. Make sure the domestic water system is powered up and the boat's tank has at least 30 gallons (120 Liters) of water to purge the storage chemicals from the system. Confirm that the charcoal filter is installed in the feed pump module, and the domestic water line is connected.

1. **Open the pressure relief valve on the Clark Pump. Remove the green tag and spacer.**
2. Turn the yellow service valve on the feed pump module to OFF. This is the center (horizontal) position. See Figure 1.
3. Power up the control. Bypass the purge mode by pushing **Stop** and **AutoRun** simultaneously. "PURGE MODE BYPASSED" should appear.
4. Push the **Auto Store** button and allow the system to run a full flush cycle. Do this **six** times to purge the storage chemicals.
5. Connect the inlet and brine discharge service hoses per Figures 2 and 3, and route them into the 5 gallon (20 liter) bucket. Disconnect the product tube from the diversion valve, and using another small piece of tube, route it into the bucket.
6. Push the **Auto Store** button one or two more times to fill the bucket with fresh water from the brine discharge service hose (hose attached to Clark Pump). Press **Stop** when the bucket is full.
7. Rotate the yellow service valve to the SERVICE position.
8. Mix the salt to the proper proportion or use an aquarium hydrometer to adjust the salinity level. If a hydrometer is available, mix to a specific gravity of 1.025.
9. Push the **Auto Run** button, allow the system to prime and then close the pressure relief valve. The system should build pressure and after several minutes start making water, with the brine and product water recombining in the bucket to be cycled again. This will gradually heat the water. Do not let the water temperature exceed 120 deg. F (49 deg. C).
10. Run the system under pressure, checking for proper operation and leaks. After testing the system, replace the brine discharge hose and product tube, and turn the service valve to RUN. You can now flush the system by pressing the **Auto Store** button.



Remove tag and washer



OPEN PRESSURE RELIEF VALVE

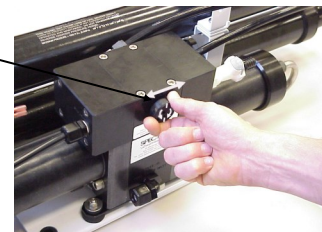

Fig. 1



Fig. 2



Fig. 3

Normal Operation and Fresh Water Flush

If the system has been pickled or stored, use the **New System Startup procedure on page 31.**

You should fresh water flush your watermaker after every use. Remember that you need to run the system almost a half hour to make enough fresh water for one flush. You may notice that the system output is higher when charging your batteries, as the watermaker is voltage sensitive.

1. Check to see that the inlet and brine discharge seacocks are open.
2. Push **Auto Run** one or more times. The machine will run for one hour for each time the button is pushed, then shut off and automatically do a fresh water flush.
3. Run the system until you have filled your tank or have made enough to meet your requirements for several days.
4. After the system fresh water flushes and shuts down it will enter the **Auto Store** mode, which will flush the system at programmed intervals. See the next page.
5. You may stop the system at any time with the **Stop** button. If the **Stop** button is pressed during operation, the system will not flush itself or go into Auto Store mode.

Auto Store mode: The timer counts down the hours until the next Fresh Water Flush.



Auto Store

Warning! Proper understanding of the Spectra flush system and the vessel's fresh water system is mandatory for extended use of Auto Store. The flush cycles must not be allowed to drain all the fresh water from the tank or damage to the vessel's systems and the watermaker may occur.

As described in Normal Operation and Fresh Water Flush, on page 35, the Auto Store function flushes the watermaker at programmed intervals. As long as the watermaker is flushed with fresh water every 5 days (30 days with the Z-Ion) you need not store the system with chemicals.

- Make sure there is enough water in the fresh water tanks to supply the watermaker for more than the expected time of operation in the Auto Store mode. If there isn't enough fresh water in your tank, seawater will be drawn in to make up the difference, and the system will not be completely flushed with fresh water. The Ventura requires about 3 –4.5 gallons (11—13 liters) for each flush. The boat's pressure water supply must be on and stay on while the system is in Auto Store mode. If these conditions cannot be met, then pickling with SC-1 storage chemical or propylene glycol is preferable.
- Make sure the pressure relief valve on the Clark Pump is closed.
- The system must be continually powered during the Auto Store mode. Turning off the power will disable the automatic fresh water flush and damage may occur.
- **Pressing the Auto Store button once** will flush the system and then activate the flush interval cycle: The feed pump will start, the flush water solenoid will open and the display will read "FRESH WATER FLUSH" with a countdown timer. After 3 minutes (adjustable) the pump will stop, the display will read "FLUSH TIMER INTERVAL," and the countdown timer will reflect the number of hours until the next flush.
- **Pressing and holding the Auto Store button for 5 seconds will engage a one-time flush.** The display will read "FRESH WATER FLUSH" while flushing, then the default display will appear when finished. The system will not re-flush at programmed intervals.
- **Pressing the Stop button** will cancel the Auto Store Mode.

Flush Duration Adjustment

The Ventura Flush Duration is set to a factory default of 3 minutes, which is usually the right amount of time to ensure that sea water is thoroughly flushed out of the watermaker using the least amount of fresh water. However, due to different lengths of hose runs, different rates of flow, and different pressures in shipboard fresh water systems, the flush duration can be optimized for your boat.

Detailed instructions about how to access the programming function and set the flush duration can be found on page 70, Programming From the Display. Set the Flush Duration so that the fresh water flush comes to an end just as the salinity of the brine discharge drops below 1000 PPM, or no longer tastes brackish. Since the flush duration can only be adjusted in round minutes, you may want to lessen the duration to 2 minutes, to save water, or increase to 4 minutes to ensure a thorough flush.

Also, the charcoal filter is rated for 1.5 GPM (6 LPM): If the system pushes more than 1.5 GPM through the charcoal filter (4.5 gallons in 3 minutes), a flow regulator can be added.

Alarm Override and Manual Operation

In the event of a sensor failure resulting in a shut down due to a false alarm, the failed sensor can be overridden using the programming function on the display (pages 68-70). High Pressure, Service Prefilter, System Stalled (airlock), and Salinity Probe Failed can all be overridden and the system will still run automatically with all other functions intact. **Be absolutely certain that the alarm is false before overriding the automatic controls.**

In the event of a complete MPC control failure, the system may be operated manually using the Manual/Auto switch on the MPC Control Box. Automatic controls and water monitoring are disabled in manual mode, so the diversion valve will send all of your product water overboard through the brine discharge. The diversion valve must be bypassed, and product water must be routed directly to the tank from the membrane product water outlet.

In the event of complete MPC control failure, the system may be operated manually as follows:

- Switch on the feed pump by setting the feed pump switch to RUN MAN. The automatic safety controls are disabled in manual mode. Shut the unit down if the Clark pump does not cycle, if air is continuously present in the intake line, or if the feed pump is excessively noisy.
- Always discard the product water for the first few minutes of operation as the initial product water may not be potable. Take a water sample by loosening the 1/4-inch product tube fitting at either the feed pump module or the membrane outlet. Check it with a handheld salinity meter or taste it.
- The diversion valve is an electrically operated three-way valve, which is normally energized by the MPC controls in order to send water to the tank. It will not open automatically in manual mode, and must be opened using the mechanical override button. **The valve is located behind an access opening on the left side of the feed pump module.** Push the manual override button in and rotate 1/4 turn clockwise to open the valve.

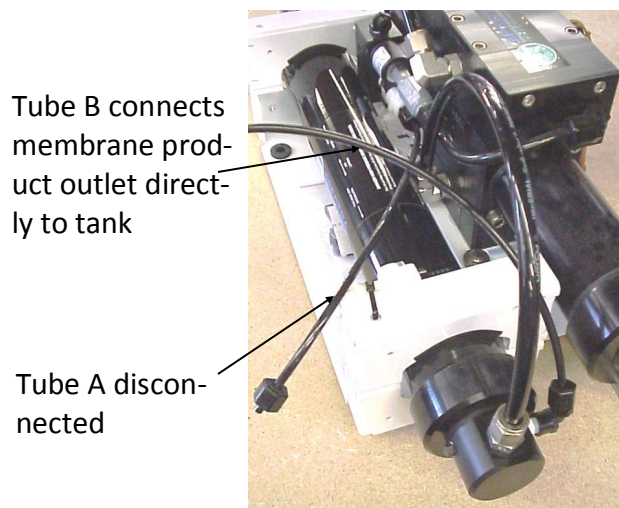
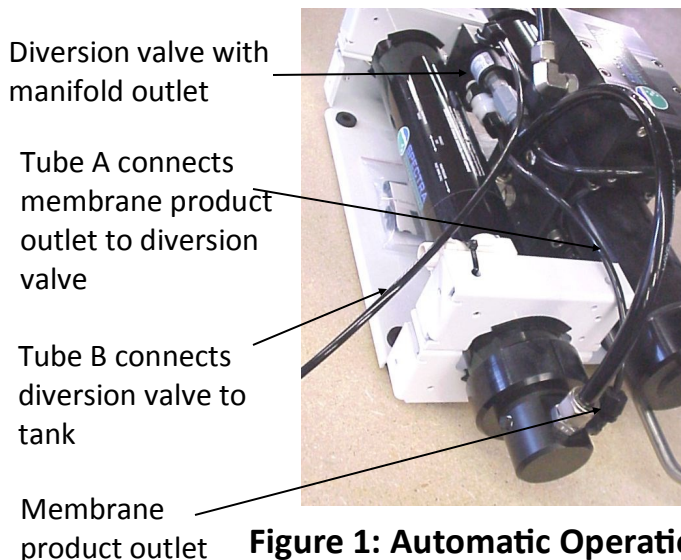

Maintenance, Storage, and Troubleshooting

Suggested Spares for Ventura MPC

Short term cruising, weekends etc.

A basic cruise kit B. This kit consists of three 5 micron filters, three 20 micron filters, and SC-1 storage chemical.

Cruising 2 to 6 months at a time.

Two basic cruise kits, one replacement charcoal filter, and one replacement feed pump head.

Longer than 6 months

Additional filters, offshore cruising kit consisting of Clark Pump seals, O-rings, tools and membrane cleaning chemicals. One replacement strainer screen, replacement O-ring for strainer screen, and replacement O-rings for the filter housings. Spare feed pump or feed pump diaphragm.

Common Parts:

Item	Part Number
SC-1 STORAGE CHEMICAL	KIT-CHEM-SC1
SC-2 CLEANER	KIT-CHEM-SC2
SC-3 CLEANER	KIT-CHEM-SC3
BASIC CRUISE B	KIT-BCK-B
OFFSHORE REBUILD KIT	KIT-OFFSH
5 MICRON FILTER	FT-FTC-5
20 MICRON FILTER	FT-FTC-20
CHARCOAL FILTER	FT-FTC-CC
5" STRAINER SCREEN	FT-STN-5S
OIL/WATER FILTER	FT-FTC-OW
FEED PUMP	EL-FP-12V or 24V
FEED PUMP HEAD	PL-PMP-SFPH
FEED PUMP DIAPHRAGM	EL-FP-DP
5" STRAINER O-RING	SO-STN-5SS
FILTER HOUSING O-RING	SO-FHS-10H
SALINITY PROBE	EL-MPC-SP4
CHARCOAL FILTER HOUSING O-RING	SO-FHS-3PCS10

Maintenance

General

Periodically inspect the entire system for leakage and chafing. Repair any leaks as soon as you find them. Some crystal formation around the Clark Pump blocks is normal. Wipe down any salt encrusted areas with a damp cloth.

Watermakers are at their best when run regularly. Biological fouling in the membrane is more likely when a watermaker sits idle. A warm environment will cause more growth than a cold environment. A fresh water flush every five days (30 days with the Z-Ion) will greatly reduce biological growth, but may not stop it completely. Both the Z-Brane or Z-Ion systems protect the membrane from bio-fouling without the use of storage chemicals.

The Seawater Strainer

The seawater strainer's stainless steel element should be inspected, removed, and cleaned as needed. Ensure that the thru-hull is closed before disassembly and the gasket is in place before reassembly. When the system is put into storage, remove the strainer, rinse with fresh water, and reassemble dry to impede corrosion. Check frequently during operation.

The Pre-filters

Service the pre-filters on a regular basis. The MPC will alarm when the filters reach a 10 PSI (.7 BAR) pressure differential. If you use the system until it stops at a 10 PSI differential (.75 BAR) then the filters will have to be discarded. Extremely dirty filters will harm system performance and may cause the feed pump to cut out from high pressure. Leaving dirty filters in the machine during long idle periods will cause biological contamination.

To service the prefilters, turn yellow service valve on feed pump module to OFF, open the housings, and remove the old filters. Clean out the housing bowls, reassemble the housings with new 5 and 20 micron filter elements. Leave dry until the next startup. Use only Spectra-approved filters or you may void your warranty. The filters may be cleaned up to three times with a soft brush and water in a bucket, hung overboard overnight, or dragged behind your vessel underway. Drying the filters in the sun helps kill microbes and remove bad smells. Occasionally, lightly lube the filter housing O-ring with silicone grease.

Oil/Water Separator (Optional)

To install oil water separator capability, remove the 20 micron filter from the dual filter housing and replace with the oil water separator element. Service as you would per the instructions above.

The Charcoal Fresh Water Flush Filter

Replace the charcoal filter element at least every 6 months. This filter protects the membrane by removing chlorine from the flush water. Use only a Spectra-approved replacement. See page 56.

Maintenance continued...

The Feed Pump and Clark Pump

The feed pump and the Clark Pump require no routine maintenance except inspection for leaks. Tighten any hose clamps or fittings that show signs of leakage. The high pressure fittings threaded into the Clark Pump have O-ring seals with a straight thread. These should never leak and should never be over-tightened. If one of the tube nuts starts to leak, it can be unthreaded, sealed with a bit of silicone grease or oil, and tightened with two wrenches very tightly. See instructions on page 15.

The Membrane

Always perform a flow test (page 52) before cleaning your membrane. Cleaning shortens the lifespan of membranes, so only clean a membrane if you have ruled out other possibilities for low production or poor water quality. The leading cause of fouling is biological growth that forms when the system is left unused without flushing or pickling. Fouling from mineral scaling can happen under certain seawater conditions, or from rust. Monitor the product salinity and feed pressure for higher than normal readings, take environmental conditions into consideration:

- Cold feed water or clogged prefilters can cause high pressure.
- Low product flow is usually due to low voltage, a worn feed pump, or worn Clark Pump.

Test to see if biological growth has occurred: Before running the system, remove the prefilters and examine their condition. If the filter housings are full of smelly, discolored water, the system was not properly stored. Install clean pre-filters.

Next check the membrane. Detach the brine discharge hose, attach the brine service hose, and lead it to a bucket. Open the pressure relief valve 1/2 turn, and manually run the system for 30 seconds (metal toggle switch on feed pump module). Examine the brine water: If it is discolored and smells bad, perform an SC-2 cleaning with unchlorinated water before running the system pressurized. If the brine is fairly clean, follow the New System Startup procedure on page 33 and run normally. Check for performance. Clean the membranes **only if** performance is reduced.

See the **Cleaning Procedure** on page 48 for complete instructions.

Introduction to Spectra Chemicals

We use four types of chemicals: SC-1, SC-2, SC-3, and propylene glycol antifreeze. SC-1 and propylene glycol are for system storage, while SC-2 and SC-3 are for membrane cleaning. **Do not use metasodium-bisulfate, citric acid, or any other storage chemical not supplied by Spectra.** These chemicals, used to store other watermaker brands, are very acidic and will damage the Clark Pump and void the warranty.

Note: Never use any chemicals with the system pressurized! Always open the pressure relief valve 1/2 turn. Always follow the instructions for purging the chemicals as shown in the New System Startup section (page 35) of your owner's manual.

Storage

SC-1 prevents biological growth when your system is idle. It should not be used as a cleaning chemical, nor will it protect your system from freezing. A jar of SC-1 is mixed with 1 to 2 gallons of product or dechlorinated fresh water in a bucket and circulated through the system for 10 minutes. This treatment will protect the system for six months, after which the SC-1 treatment must be repeated. To use SC-1, follow the instructions for **Ventura MPC Storage Procedure** on page 48.

Spectra systems should be stored with propylene glycol if freezing is likely to occur. Propylene glycol can be used instead of Spectra SC-1 storage chemical for storage in any climate, and treatment is effective for one year. Propylene glycol is a food-grade antifreeze used to winterize RV's, boats, and cabins. Do not use ethylene glycol automotive antifreeze, which is toxic and will damage the system.

The propylene glycol formulations sold in marine and RV stores are usually diluted with water. The water remaining in the watermaker before the storage procedure will further dilute the antifreeze, reducing the microbial protection and increasing the temperature at which the mixture will freeze.

Antifreeze labeled "Minus Fifty" is a 25% solution and will begin to form an icy slush at about +15Degrees F (-10C) and will only provide burst protection to about Zero F (-18C). After a further 50% percent dilution by water remaining in the watermaker, "Minus Fifty" antifreeze will only protect from bursting down to about +25F (-4C). Therefore if low temperature freezing protection is required a 60% or stronger antifreeze should be used. 60% solutions are labeled "Minus 100" and will provide burst protection to -15F (-27C) even after a fifty percent dilution with residual water. "Minus 200" formulations are pure propylene glycol.

Introduction to Spectra Chemicals continued...

Complete microbial preservative protection requires a 25% solution of propylene glycol, so care must be taken that the solution remaining in the watermaker during long term storage is at least 25%, even if freeze protection is not required. For these reasons Spectra recommends that all pickling be carried out with a 60% or greater concentration.

Propylene glycol can be difficult to flush from a membrane, especially after extended storage periods. This results in high salinity water (high PPM) and residual flavor in the product water. We recommend flushing the system WITH THE PRESSURE RELIEF VALVE OPEN for 4-6 hours after storage with propylene glycol—the longer the better. If, after extended flushing, you still experience low product water quality, cleaning with SC-2 usually removes all traces of propylene glycol and returns the salinity to the level it was before storage with propylene glycol. See the **Cleaning Procedure** on page 48.

See **Winterizing with Propylene Glycol** on page 47.

Cleaners

Cleaning can be detrimental to the membrane and shorten its life. Avoid unnecessary cleaning, and avoid cleaning as a diagnostic tool.

SC-2 is an alkaline cleaner used to remove light oil, grime and biological growth. It is most effective if heated to 120 deg. F (49 deg. C), which is difficult on a boat. In most cases the water quality will increase in PPM (salinity) after an SC-2 cleaning. After a few hours it should recover to near the level it produced before the cleaning.

SC-3 is an acid cleaner used to remove mineral and scale deposits. In most cases this is used first and if there is no improvement, go on to the SC-2. SC-3 will in most cases lower the product PPM and overall pressures. Scaling is a slow process that may take several months or years. SC-3 is less harmful to the membrane and will almost always improve the performance of an older membrane.

For cleaning with either SC-2 or SC-3, see the **Cleaning Procedure** on page 48.

Ventura MPC Storage Procedure

1. Turn the yellow service valve on the feed pump module to OFF (horizontal, see photo).
2. Push **Auto Store** to fresh water flush the system. Repeat, to flush the system twice.
3. Remove the cap on the service port on the feed pump module and install the inlet service hose from the service kit. Remove the quick disconnect fitting from the brine discharge outlet of the Clark Pump, and replace it with the quick disconnect brine discharge service hose. Lead both hoses to a 5 gallon bucket.
4. Push the **Auto Store** button and run the feed pump until you have one gallon of fresh water in the bucket from the brine discharge service hose. Stop the system.
5. Mix 1 container of SC-1 storage compound with the water in the bucket.
6. **Make sure the pressure relief valve on the Clark Pump is OPEN (un-pressurized) by turning 1/2 turn counterclockwise**
7. Place the yellow service valve in the Service position (pictured below).
8. Turn on the feed pump using the manual control switch on the MPC 5000 Control Box. The solution will be drawn from the bucket with the service hose, and returned to the bucket from the brine discharge service hose. Circulate the storage chemical in the system for approximately 10 minutes. Turn off the feed pump.

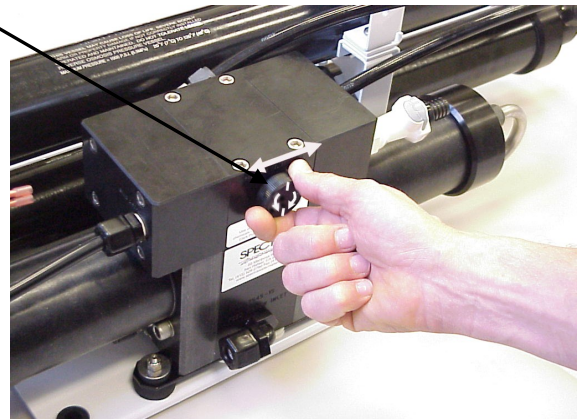

Clean Up

Remove the brine discharge service hose from the Clark Pump, and replace the brine discharge hose that leads to the thru-hull. You may now pump the bucket dry by using the manual control switch on the MPC Control Box.

Turn the service valve 180° back to the RUN position, and remove the inlet service hose. Close the seacock, drain and clean the strainer and any filters in the system. Reassemble dry. Leave the pressure relief valve open, since the next time you run the system you will need to purge the storage chemicals with the system unpressurized.



Service valve OFF



Service hose connected and service valve to SERVICE



Connecting brine discharge service hose

Winterizing with Propylene Glycol

See description of propylene glycol formulations, and flushing from system, on page 44-45.

1. Turn the yellow service valve on the feed pump module to OFF (horizontal, see photos).
2. Push **Auto Store** to fresh water flush the system. Repeat, to flush the system twice.
3. Connect the inlet service hose to the feed pump module (above the yellow service valve) and lead the hose to the bottom of a bucket. Connect the brine service hose, and run it into a second container.
4. Turn the yellow service valve on the feed pump module to the SERVICE position.
5. Pour 1 gallon (4 liters) of propylene glycol of appropriate concentration (see pages 46-47) into the bucket with the intake service hose.
6. **Make sure the pressure relief valve on the Clark Pump is OPEN 1/2 turn (un-pressurized).**
7. Run the feed pump using the manual switch on the MPC control box until about a gallon of water has flowed from the brine discharge service hose, or antifreeze appears. Propylene glycol will look slightly different, and feel more slippery, than water. Stop the pump. Add more propylene glycol to the intake bucket if necessary.
8. Lead the brine discharge service hose into the intake bucket of propylene glycol. The service hose will now draw propylene glycol from the bucket, and the brine discharge service hose will return it. Run the feed pump and circulate the antifreeze for 10 minutes.
9. Stop the feed pump. Close the seawater intake and turn the yellow service valve to OFF. Drain the seawater strainer and the hose leading to the feed pump module. Disconnect the product tubing from the membrane housing and blow residual water out of the tubing. Empty the charcoal filter housing and flush water lines.

Your watermaker is now protected from biological growth and freezing for one year.



Service Valve OFF

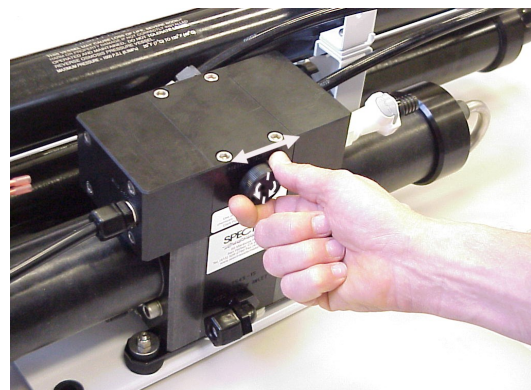

Open the Pressure Relief Valve



Service hose connected and service valve to SERVICE



Connecting brine discharge service-hose

Membrane Cleaning Procedures

Spectra cleaning compound (SC-2 or SC-3) must be mixed with fresh water at a ratio of 1 container of compound to 3 gallons (12L) of unchlorinated water. An average of two gallons (8L) of water is already present inside a Ventura system, so this water must be figured into the mixture. A Ventura system requires one container of compound per cleaning.

1. Turn the yellow service valve on the feed pump module to OFF (horizontal, see photo).
2. Push **Auto Store** to fresh water flush the system. Repeat, to flush the system twice.
3. Remove the cap on the service port on the feed pump module and install the inlet service hose from the service kit. Remove the quick disconnect fitting from the brine discharge outlet of the Clark Pump, and replace it with the quick disconnect brine discharge service hose. Lead both hoses into a 5 gallon (20 liter) bucket.
4. Push the **Auto Store** button and run the feed pump until one gallon of fresh water runs into the bucket from the brine discharge service hose. Stop the system.
5. Turn the yellow service valve to the SERVICE position.
6. **Make sure that the pressure relief valve on the Clark Pump is open (un-pressurized).**
7. Mix the cleaning chemical in the bucket. If possible, heat the solution to 120 deg. F (49 deg. C).
8. Start the system using the manual switch on the MPC control box. The intake service hose will draw solution from the bucket and the brine discharge service hose will return it. Circulate the solution through the system in this manner for 45 minutes.
9. Stop the pump. Replace the brine discharge overboard hose and run the pump until the bucket is empty. Stop the pump and turn the yellow service valve back to the RUN position. Restart the pump and run for 20 minutes to flush the chemicals out of the system (**DO NOT CLOSE the pressure relief valve!**)
10. Move the switch on the MPC Control Box to AUTO. The system may now be restarted, flushed, or stored.



Service valve in OFF position

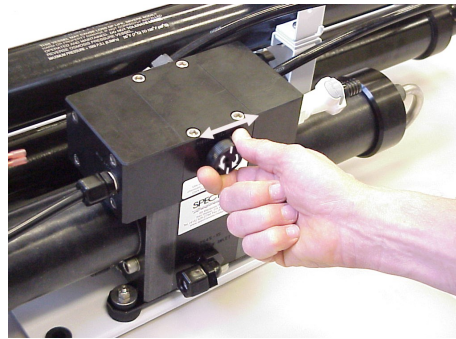

Open the pressure relief valve!



Service hose connected and service valve to SERVICE



Attaching brine discharge service hose

Troubleshooting Ventura MPC Systems

SYMPTOMS	PROBABLE CAUSE	REMEDY
Feed pump runs constantly, will not turn off	<ul style="list-style-type: none"> Manual switch in ON position on control box 	<ul style="list-style-type: none"> Turn off manual switch on control box
Feed pump runs with loud noise	<ul style="list-style-type: none"> Intake blocked Air in system 	<ul style="list-style-type: none"> Check thru-hull valve Check sea strainer for leaks Check fresh water flush module for leaks Re-prime system (restart)
No lights or display, system does not operate	<ul style="list-style-type: none"> Remote display not connected 	<ul style="list-style-type: none"> Check display cable connections at back of display and at control box Check and reset main DC supply breaker Check for voltage (12 or 24 VDC) at control box power input studs Try manual switch on MPC control box: If pump runs, then control or display is defective
Pump runs intermittently, cycling on/off	<ul style="list-style-type: none"> Overpressure switch on ShurFlo pump opening 	<ul style="list-style-type: none"> Adjust or replace switch (see page 58)
Display activates, but pump will not run	<ul style="list-style-type: none"> Loose or broken pump wire connection Tanks are full (if equipped with tank switch) 	<ul style="list-style-type: none"> Check wiring at terminal block inside MPC Check tanks– system cannot be started if tanks are full.
System runs, no product water delivered to water tanks, GPH bar graph shows OK, “Good” LED activated	<ul style="list-style-type: none"> Diversion valve inoperative or wiring fault. Disconnected or broken product tubing Diversion valve plunger stuck 	<ul style="list-style-type: none"> Check wiring at diversion valve and inside control box Check product tubing Disassemble and clean diversion valve plunger or replace valve (contact factory)
System runs, no product water delivered to water tanks, GPH bar graph shows OK, “reject” LED activated	<ul style="list-style-type: none"> High salinity of product water, causing system to reject water Salinity probe out of calibration or defective, bad cable Chlorine damage to membranes Pressure relief valve open 	<ul style="list-style-type: none"> Check for low feed pressure Check for leaks at high pressure hoses Test product water with hand-held tester– if over 500 PPM for 1 hour, contact factory Close pressure relief valve

Ventura MPC Fault Alarms

SYMPTOMS	PROBABLE CAUSE	REMEDY
<p>“System Stalled” (“system stalled” may alarm when using the control panel to run system for servicing with the pressure relief valve open– use manual override switch instead)</p>	<ul style="list-style-type: none"> • Pressure relief valve open • Intake thru-hull closed • Airlocked system • No signal from Rotoflow meter 	<ul style="list-style-type: none"> • Close pressure relief valve • Check thru-hull • Purge air • Clean or replace Rotoflow meter
<p>“High Pressure”</p>	<ul style="list-style-type: none"> • Blocked brine discharge • Fouled membrane 	<ul style="list-style-type: none"> • Check brine discharge • Clean membrane
<p>“Voltage Too High” “Voltage Too Low”</p>	<ul style="list-style-type: none"> • Battery voltage too high or low • Loose wires or poor connections 	<ul style="list-style-type: none"> • Charge batteries • Check charging voltage • Check power connections
<p>“Re-starting”</p>	<ul style="list-style-type: none"> • No signal from Rotoflow meter at startup. • System stalled 	<ul style="list-style-type: none"> • See remedy above for “system stalled”
<p>“Check Fuse” (followed by fuse number)</p>	<ul style="list-style-type: none"> • Blown fuse at circuit board 	<ul style="list-style-type: none"> • Replace fuse (mini automotive type ATM). See page 82. • Look for cause
<p>“Service Prefilter”</p>	<ul style="list-style-type: none"> • Clogged filters • Loose or defective pressure sensor wires 	<ul style="list-style-type: none"> • Install new filters • Check sensor wiring • With clean filters, recalibrate Differential Limit or Outlet Offset (see pages 70-72).
<p>“Salinity High”</p>	<ul style="list-style-type: none"> • High product water salinity • Chlorine damage to membranes • Defective salinity probe or cable, cable disconnected 	<ul style="list-style-type: none"> • Check for low feed pressure • Check for leaks at high pressure hoses • Remove and clean probe contacts. Check calibration • Check cable connections • Clean membrane

Poor Product Water Quality

With any product water quality issue, you must ensure accurate calibration if you are using a salinity meter. For general quality evaluation, your taste is always good enough.

Membranes are not an exact science and two identical systems can have different product quality. World health standards deem water of up to 1000 PPM of total dissolved solids acceptable for drinking. We consider any thing below 750 PPM acceptable but not ideal, and anything below 500 PPM excellent. Factors that could affect water quality are addressed below.

LOW SYSTEM FLOW OR PRESSURE will equate to lower product quality (higher PPM).

Ventura systems, which have a higher feed to output pressure ratio (See nominal pressures under Flow Test, page 55), as well as a higher feed flow/membrane area ratio, will produce water in the 150-200 PPM range.

DAMAGE TO THE MEMBRANE by chlorine contamination. Flushing the system with chlorinated water will irreparably damage the membrane. Charcoal filters are used to absorb any chlorine which might be present in flush water. They must be of proper specification to be suitable. See page 56. There is no test for chlorine damage except the process of elimination of other causes.

DIRTY OR SCALED membranes. A dirty (foreign material), scaled (mineral deposits), or contaminated (bacterial growth) membrane can result in poor water quality and abnormal operating pressures. If operating pressures are above normal, then cleaning is indicated. If the system pressures are within operating normal range, cleaning may have little result. Avoid cleaning as a diagnostic tool. Low water quality after storage with propylene glycol can usually be remedied by extended flushing or an SC-2 cleaning. (See pages 44-45 and 48.)

MECHANICAL LEAKAGE within the membrane pressure vessel. This is an unlikely but possible cause of poor water quality. A pinched or damaged O-ring within the pressure vessel, a scratch on the product tube on the membrane, a scratch within one of the end caps, or a seal fouled by contamination could allow sea water into the product water.

If system flow (product plus brine) is 1.5 GPM or above, the membrane is clean, the product flows are consistent with the system flow and the water quality is still not acceptable, then replacement of the membrane is indicated.

Ventura Flow Test

The flow test is the most useful diagnostic test for system performance, and should be done before replacing or cleaning your membrane. Changes in production or water quality are normally caused by something **other than** the membrane, unless the system has been left unused for a long time.

Before the flow test, change all filters and clean the sea strainer. Carefully check for water or air leaks, as air in the system will cause low production and erratic salinity. Look for air bubbles in the product flow meter, feed water hoses, and brine overboard hose.

Run the system and watch the feed pressure very closely. If the feed pressure to the Clark Pump is asymmetrical from one stroke to another, this could be part of the problem. A difference of a few PSI is acceptable, but anything over that is an issue. If the pump is asymmetrical, Clark Pump repairs should be done before continuing with these tests.

If no asymmetry is noted, continue with this test.

Make sure the ShurFlo overpressure cutout switch (PL-PMP-SFPH) is set to 125 PSI. With the pump running, close the brine discharge thru-hull or kink the brine discharge hose. The feed pressure should rise to 125 PSI, then the pump should shut off. If the pump shuts off at a lower pressure see Adjust ShurFlo Pressure Switch on page 45.

You will need a graduated bucket, either a graduated pitcher or large measuring cup, and a stopwatch. Before the flow test, change all filters and clean the sea strainer. Log the voltage at the feed pump at the same time. Confirm at least 12.5 Volts at the feed pump on 12-Volt DC systems; 25 volts on 24-Volt DC systems.

Take two measurements and compare them with the table on the following page. The first measurement is the product flow alone. The second is the product flow combined with the brine discharge flow to get the total flow or feed flow. You may take these measurements by two methods:

1. Time the product flow into a graduated pitcher, then divert both the product flow and brine discharge together into a bucket to measure total flow.

OR

2. Divert the product flow into the pitcher while diverting the brine discharge into the bucket. Time the flow of both. After calculating the product flow, pour the pitcher of product into the bucket of brine to measure total flow.

The ratio of product flow to total flow gives us our recovery rate, as a percentage. If the percentage is below the minimum it indicates an internal leak in the Clark Pump.

1. Product Flow: Product flow is expressed in Gallons Per Hour (GPH) or Liters Per Hour (LPH), by this equation:

$3600 \div \text{time in seconds} \times \text{quantity of water in gallons or liters} = \text{GPH or LPH}$
 There are 3600 seconds in an hour.

Example: It took 3 minutes and 35 seconds to collect 1 gallon of product water.
 $3600 \div 215 \times 1 = \mathbf{16.74 \text{ GPH}}$ (3 minutes, 35 seconds is 215 seconds)

Example: It took 2 minutes and 25 seconds to collect 2.5 liters of product water.
 $3600 \div 145 \times 2.5 = \mathbf{62.07 \text{ LPH}}$ (2 minutes, 25 seconds is 145 seconds)

2. Total Flow or Feed Flow: Feed flow or total flow (brine + product) is expressed in Gallons Per Minute (GPM) or Liters Per Minute (LPM), by this equation:

$60 \div \text{time in seconds} \times \text{quantity of water in gallons or liters} = \text{GPM or LPM}$

Example: It took 1 minute and thirty-seven seconds to collect 5 gallons of total flow.
 $60 \div 97 \times 5 = \mathbf{3.09 \text{ GPM}}$ (1 minute, 37 seconds is 97 seconds)

Example: It took 53 seconds to collect 12 liters of total flow.
 $60 \div 53 \times 12 = \mathbf{13.58 \text{ LPM}}$

3. Recovery Rate: Product Flow \div Total Flow = Recovery Rate %

Example: $\frac{6.5 \text{ GPH product flow}}{1.7 \text{ GPM total flow} \times 60} = \mathbf{.063 \text{ or } 6.3\%}$

(you must first multiply total flow by 60 to convert from GPM to GPH)

System	Feed		Static *	Feed Flow				Product Flow			
	Pres-sure			Flow		MIN	MIN	Flow	Flow	MIN	MIN
	psi	bar	psi	gpm	lpm	gpm	lpm	gph	lph	gph	lph
Ventura	60-70	4.2-5	10-15	1.7	6.4	1.65	6.2	6.5	24.6	5.7	21.5
VT 200	80-90	5.6-6.3	20-25	1.7	6.4	1.6	6.0	8.3	31.4	7.7	29.1

***pressure relief valve open ½ turn**

In order to make good quality product water, you need the proper amount of feed water flow, as in the table above. Compare the product flow to the total feed flow. Product flow should be 6.5% minimum 5.5%) of total flow for a Ventura 150, and 9% (minimum 8%) of total flow for a Ventura 200T. If product percentage is low, you may have an internal leak in the Clark Pump.

For every $\frac{1}{10}^{\text{th}}$ of a GPM feed water flow loss, we will lose about $\frac{1}{2}$ gallon per hour of product flow and the salinity will go up 100 PPM.

Low feed flow combined with low system pressures is most frequently caused by a worn Shurflo pump head (PL-PMP-SFPH).

Technical Bulletins

The following pages include Spectra's most commonly used technical bulletins, covering tests, adjustments, troubleshooting, and common points of confusion. Many more technical bulletins are available on the Spectra website, www.spectrawatermakers.com.

ACCUMULATOR PRESSURE

Your Spectra watermaker is supplied with a pressure accumulator tank (PL-ACC-TK), which should be installed in the feed water line between the pre-filters and the Clark Pump.

The purpose of the feed line accumulator is to reduce the spikes in the feed pressure caused by the cycling of the Clark Pump. If the accumulator is not properly charged it can lead to problems with the Shurflo Pump pressure cutout switch (see page 58). The accumulator has a Schrader air valve, like a car tire, which allows the internal air bladder of the accumulator to be pre-charged. The accumulator should be pumped up to about 65 psi (4.5 bar) for best results. Add air using a tire pump or air compressor. You can experiment with the exact pressure that will give the best pulsation dampening on your installation.

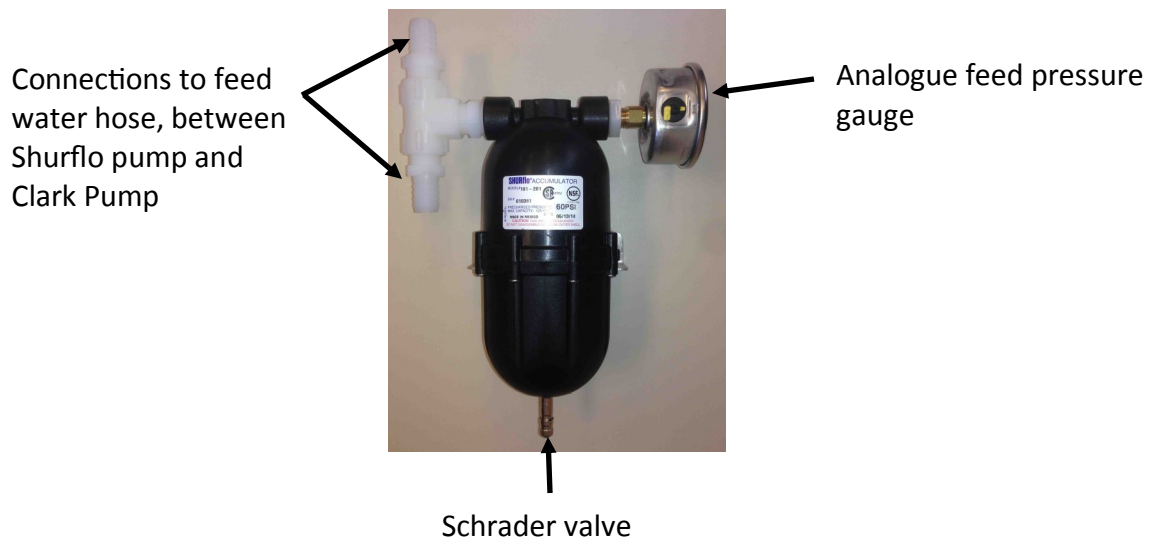

PREFILTERS

During normal operation, the feed water is filtered in two stages. First it passes through a fine mesh metal sea strainer, which protects the feed pump from foreign materials and sea creatures. After passing through the feed pump, the feed water passes the filter housings containing 20 and 5 micron elements, removing very fine particles that could damage the Clark Pump and shorten membrane life. An additional carbon filter prevents the entrance of chlorine during fresh water flushing (see next page).

Pre-filter maintenance schedules will vary widely depending on how and where the system is used. If large amounts of feed water are run through the system over a relatively short period of time in biologically fertile near-shore waters, the prefilters will plug up, water production and quality will drop, and the system pressure will change dramatically. In blue water conditions the pre-filters may only need to be changed every week or two.

When operated for only an hour or two a day in inland or near-shore waters, the trapped plankton will begin to decay in the filters long before the elements plug up. The decaying plankton and bacteria will cause a rotten egg smell in the product water. This decay will set in overnight in tropical waters, or after a week or two in higher latitudes. If handled gently and changed regularly before they get too smelly, filters can be cleaned several times. (See Maintenance, page 42.)

Our filter element part numbers are FT-FTC-XX, where the last digits indicate the micron rating. FT-FTC-5 is for a 5 micron element, FT-FTC-20 is a 20 micron element. The optional oil/water separator is FT-FTC-OW.

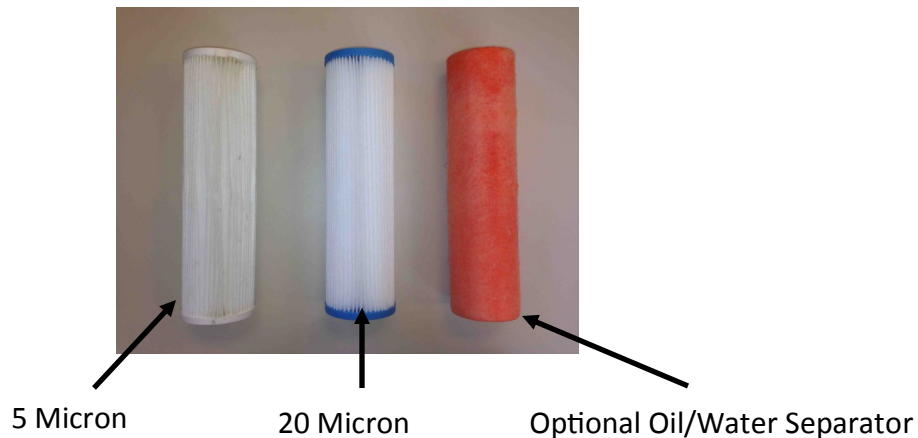

CHARCOAL FILTERS

The charcoal filter element (FT-FTC-CC) removes chlorine from the fresh water flush water supply, as the RO membrane can only handle small amounts of chlorine without permanent damage.

The charcoal filter used for the fresh water flush system will not plug up unless you have very dirty domestic water in your boat's supply tank.

The charcoal filter we supply removes 99.7% of the chlorine. Beware when buying other charcoal filters. If they don't specify the percentage of chlorine removed, don't use them. Cheap ones may remove only 60% or 70%. Also, there are aftermarket filters which are very close to, but not exactly, the right dimensions, and they will not seal in the housing. If you skimp on the charcoal filter you risk damaging a \$600.00 membrane on the first flush. The other factor is the flow rate that the filter can handle. Because the chlorine is adsorbed by the charcoal, it must remain in contact with the charcoal for a sufficient period of time for all of the chlorine molecules to be captured. The filters we use can handle 1.5 gallons (6 liters) per minute flow, and are good for 3000 gallons (12,000 liters) at 1.5 GPM, or six months, whichever comes first. Regardless of the amount of water treated, the charcoal loses its effectiveness after six months.



Charcoal filter, Spectra part number FT-FTC-CC

SHURFLO PUMP WON'T RUN

If the pump has power to it but the pump won't run, first check the pressure switch. The pressure switch (EL-FP-PS) is located on the wet end of the pump and has two red wires plugged into it (see photo, next page). Jump the two red wires together and see if the pump runs. You can safely run the system with the pressure switch jumped, just keep an eye on the feed pressure and don't let system pressure exceed 110 PSI. Replace the switch when a spare is available. The pressure switch should never open unless there is a problem with the system or it is incorrectly adjusted. See Adjust Shurflo Pressure Switch on next page.

If the pump will not run with the pressure switch jumped then it is most likely a problem with the brushes or overheat protection switch inside the motor. The motor will come completely apart by removing the two screws on the end of the motor. Remove the rear cover and paper insulator. Pull out the plastic brush holder. The thermal switch is located on one of the brush leads. With an ohmmeter, check for continuity through the switch. If it is open, you can make temporary repairs by wiring around it, being careful that your new wiring doesn't chafe on the moving parts, nor resist the springs that push the brushes on to the commutator. The overheat switch is unlikely to fail unless the motor has overheated. Consider relocating the pump or improving ventilation if the overheat protection has failed.

If any corrosion is apparent the brushes may be sticking. Once apart clean all the carbon dust from all the parts. Clean the commutator with light sandpaper. Make sure to clean the small grooves on the commutator with a small sharp tool to remove the carbon in between the segments. Adjust the springs on the brush holders so the brushes slide smoothly in and out. If the bearings are rough and binding, remove the rubber dust cover to clean them, grease them, and work them free by hand. Don't service the bearing unless absolutely necessary. Reassemble in reverse order. You can hold the carbon brushes back with paper clips inserted through the slots in the brush holder so they don't hang up on the bearing during assembly. Make sure the corrugated bearing shim doesn't push out. If it does, push it back into place.

ADJUST SHURFLO PRESSURE SWITCH

Shurflo feed pumps are equipped with a high pressure cutout switch (EL-FP-PS). This is the small black unit on the end of the wet end of the pump head (PL-PMP-SFPH) where the two red wires connect. If the pressure switch is not properly adjusted the pump may cut out each time the Clark pump cycles and the feed pressure spikes. When this happens the production will drop and salinity will increase. The points in the switch will fail quickly if set too low because of the constant arcing each time the Clark Pump shifts.

On the very center of the switch is a small 5/64" Allen screw. While running the system close the brine discharge seacock or kink the discharge hose, to block the flow. Watch the pressure gauge and adjust the pressure switch to shut off at 125 psi. Turn the Allen screw clockwise to increase the cut off set point.

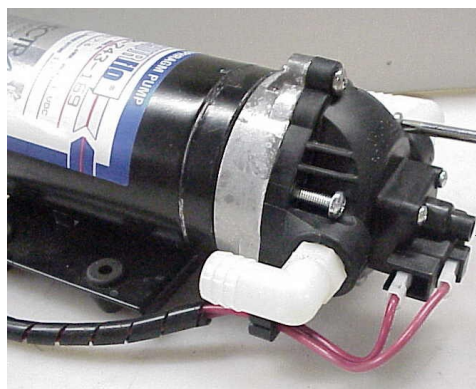

Pressure Switch
Adjusting Screw

Performing a Fresh Water Flush with a Failed Salinity Probe

In the event of a “Salinity Probe Failed” alarm on the remote display the alarm function can be defeated to allow the system to remain in the Auto Store mode until repairs can be facilitated. Access the program mode, as outlined on page 68, Programming from the Display. Scroll through the menus until you reach the Disable Salinity heading. Press the Auto Store button once, this will change the setting from NO to YES. Wait 40 seconds for the display to timeout and return to the default screen. Press Auto Store once. The system will begin Auto Store Mode, flushing itself and then initiating the flush interval timer as outlined on page 38.

Performing a Fresh Water Flush with a Failed Inlet Pressure Transducer

In the event of a “Service Prefilter” alarm on the remote display **that cannot be cleared by replacing the pre-filters**, the alarm function can be defeated to allow the system to remain in the Auto Store mode until repairs can be facilitated. Access the Program Mode, as outlined on page 68, Programming from the Display. Scroll through the menus until you reach the Disable Prefilter heading. Press the Auto Store button once, this will change the setting from NO to YES. Wait 40 seconds for the display to timeout and return to the default screen. Press Auto Store once. The system will begin Auto Store Mode, flushing itself and then initiating the flush interval timer as outlined on page 36.

MPC 5000 Programming and Controls

Introduction to the MPC 5000

Your new MPC 5000 with Battery Back-up is packed with features to make operating your Spectra Watermaker easy, intuitive, and automatic.



All operating data for your watermaker is at your fingertips, including Feed Pressure, Filter Condition, Water Quality, Operating Mode, and Elapsed Time Counter.

The MPC Control Board automatically monitors the operation of the system in real-time to ensure a long and trouble-free service life. If an operating parameter changes, the MPC can switch operating modes, shut itself down, or automatically store itself in order to protect your watermaker.

Your MPC control board can be calibrated and programmed from the remote display, quickly and easily, with only a few key strokes.

The Battery Back-up feature allows for temporary power interruptions without detrimental effects on the system. In some cases your watermaker will continue to function in its last known operating state.

Spectra MPC 5000 Operation Guide

This document outlines the MPC 5000 with Battery Backup operation. It details what is seen on the display, what outputs are active during run-time, and the functions of the different modes.

Ventura systems use a single feed pump that runs at one speed, usually without a boost pump. These systems will have 2 identical pressure transducers mounted on the 20 and 5 micron filter housings to measure feed water pressure and filter condition.

Prior to starting your system for the first time, remove the battery isolation tab located to the immediate left of the BATT + post on the MPC board.

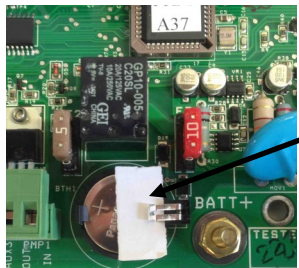

Battery Isolation Tab

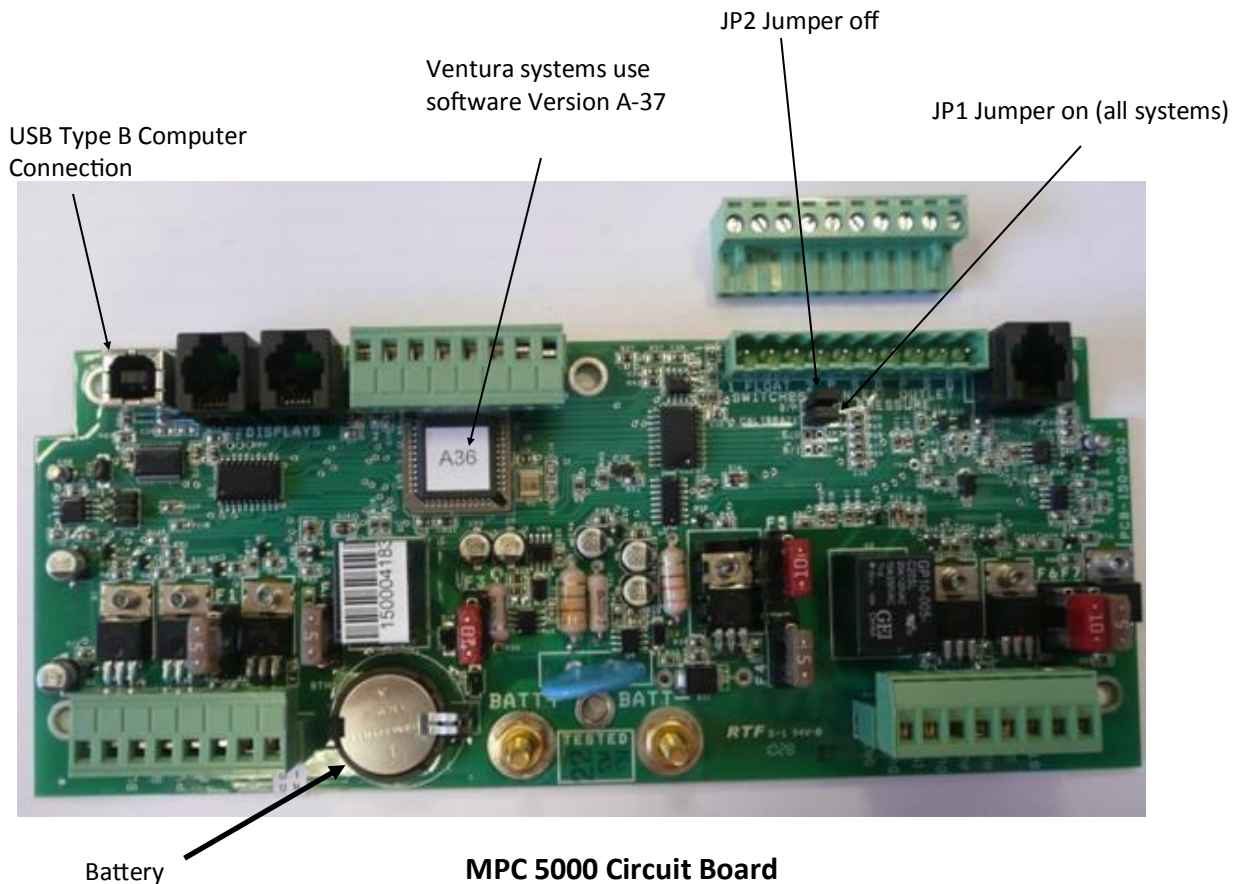

USB Type B Computer Connection

Ventura systems use software Version A-37

JP2 Jumper off

JP1 Jumper on (all systems)

Battery

MPC 5000 Circuit Board

MPC 5000 Display Controls

Auto Run: Pressing the Auto Run button in the top left corner of the display activates the MPC's automated run sequence:

- The fresh water flush solenoid valve opens for 20 seconds to prime the feed pump. The display will begin to count down from 10, then feed pump will run.
- The system will now operate in Auto Mode for 1 hour, with the duration extended by one hour each time Auto Run is pressed.
- At the end of the run cycle, the system will perform a fresh water flush. At the end of the fresh water flush cycle, the MPC will start the Flush Interval Timer (factory default flush timer interval is set to 5 days; 30 days if your system includes the optional Z-Ion).
- At the end of the flush timer interval countdown the watermaker will perform another fresh water flush and restart the flush interval timer.
- The flush interval and flush cycle will repeat themselves until the user enters another command.

Auto Run



Auto Store: Pressing the Auto Store button, in the top right corner of the display, will activate the automated storage sequence. This will automatically store the system, performing a fresh water flush once every 1 - 30 days, according to the flush timer interval settings programmed into the MPC:

- The fresh water flush solenoid will open and the feed pump will run.
- At the end of the fresh water flush cycle, the MPC will start the flush interval timer (factory default flush timer interval is set to 5 days; 30 days if your system includes the optional Z-Ion).
- At the end of the flush timer interval countdown, the watermaker will perform another fresh water flush, and restart the flush interval timer.
- This process will repeat itself until the user enters another command.

Auto Store



MPC 5000 Display Controls continued...

Stop: Pressing the Stop button in the lower left corner of the MPC display will stop any current action. In standby mode pressing Stop will activate the manual run sequence:

- The fresh water flush solenoid valve opens for 20 seconds to prime the feed pump. The display counts down from 10, then feed pump will run.
- The system will run indefinitely until the user ends the run cycle by pressing either the Stop or Auto Store buttons.
- **If the Stop button is pressed to end the manual run sequence a fresh water flush will not be initiated and raw water will sit throughout the system until another command is given. After pressing Stop it is advisable to use the Auto Store button, which will initiate a fresh water flush and restart the flush interval timer.**



Alarm/Displ: The Alarm/Displ button has several functions, depending on the current state of the system:

- **Alarm Active:** Pressing Alarm/Displ will silence the alarm. Pressing it again will reset the alarm if the underlying condition has been corrected.
- **Default Screen:** Pressing Alarm/Displ from the default screen will display the number of hours the system has run.
- **During Run Cycle:** Pressing Alarm/Displ during a run sequence will scroll through the watermaker's operating parameters: Run Mode, Production Volume, Feed Water Pressure, Filter Condition, Boost Pressure (If applicable), Production Quality, and Hours.

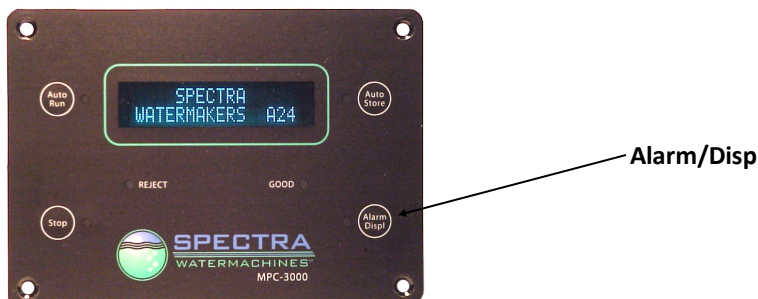

MPC 5000 Display Controls continued...

Auto Fill Mode: Pressing and holding Auto Run for 5 seconds will start the MPC in the Auto Fill Mode:

- In this mode the system will automatically start, flush, store and restart itself based on the tank level. This mode requires that the optional float switches are installed in your tank, as detailed on pages 19-20.
- **It is not advisable to operate your watermaker unattended. Severe damage to the vessel, watermaker, or other equipment may result.**

Auto Run for 5 seconds:
Auto Fill Mode



Single Flush: Pressing and holding the Auto Store button for 5 seconds will activate the single flush mode:

- The system will perform a single fresh water flush, then return to the default screen, displaying "Spectra Watermakers X-XX".
- **The system will remain in standby mode indefinitely until another key is pressed.**

Auto Store for 5 seconds:
Single Flush Mode



Programming from the Display

To enter **Program Mode** the system must be in **Standby Mode**. If the system has been de-powered recently you may need to *bypass the Purge Sequence* by pressing Auto Run and Stop at the same time.

To enter Standby Mode, press the Stop button from any other mode. The display will read SPECTRA WATERMAKERS A-XX. To have the watermaker running during the programming process, start the machine using the run manual toggle switch on the control box. The watermaker will run but the controls will be in standby mode.

To Enter Program Mode push and hold the Stop and Alarm/Displ buttons at the exact same time, holding them down for 4 seconds, after which the display should read "System Units." If the display doesn't read System Units, try again.

After entering Program Mode the buttons on the display will have different secondary functions as follows:

Alarm/Displ: Scrolls through the various programming windows.

Stop: Selects the digit in the Rotoflow meter calibration constant window to be changed. Has no function in other windows.

Auto Run: Changes the selected parameter down one unit per push.

Auto Store: Changes the selected parameter up one unit with per push.

To Exit Program Mode: Press and release the Stop and Alarm/Displ buttons simultaneously. The control will automatically revert from Program Mode to Standby Mode if no buttons are pressed for 40 seconds.

The programming windows and their functions:

SYSTEM UNITS: Select Imperial (gallons, PSI) or Metric (liters, bar) by pressing Auto Run or Auto Store.

FLOW SENSOR TYPE: Select **Rotoflow** with the Auto Run or Auto Store buttons.

PRESSURE RANGE: For the Ventura's 0-125 PSI pressure gauge, select **Low**.

DISABLE AIR LOCK: THIS IS A SAFETY SHUTDOWN. **SELECT NO**. Do not select YES unless the system is shutting down on a "System Stalled" alarm due to a **failed Rotoflow meter**.

DISABLE PREFILTER: THIS IS A SAFETY SHUTDOWN. **SELECT NO**. Select YES only if you are getting a **FALSE "Service Prefilters" alarm**.

DISABLE PRESSURE: THIS IS A SAFETY SHUTDOWN. **SELECT NO.** Select YES only if you are getting a **FALSE “High Pressure” alarm.**

DISABLE SALINITY: Factor default is **NO.** This function allows you to run the watermaker in the event of a salinity probe, probe cable, or salinity sensing circuit failure. If you get a “Salinity Probe Failed” alarm or the salinity reading cannot be properly calibrated using the Salinity Cal function, select YES to continue making water. **WARNING: When “YES” is selected the diversion valve will be energized whenever the watermaker is running and all product water will be sent to the vessel’s water tank regardless of its quality.** Before disabling the Salinity Probe, test the product water carefully and regularly.

PPM THRESHOLD: Set this parameter to the desired salinity level to reject the product water. The diversion valve will send water to the water tank when the product parts per million is lower than this set point and reject the product overboard when the salinity is higher than the set point. Factory default setting is **748 PPM.**

DIFFERENTIAL LIMIT: This function compares the pressure reading from the two pressure sensors (red and green) on the 20 and 5 micron filter housings to determine the pressure drop across the filters. The left hand number on the display is the real time pressure differential and the right hand number is the maximum differential set point. If the pressure drop across the pre-filters exceeds the set point the system will alarm “Service Prefilters” and shutdown. Factory default is **10 PSI.**

PRESSURE LIMIT: If the pressure at the feed pump discharge exceeds this set point the unit will shut down and alarm “High Pressure.” The left hand number on the display is the real time feed pressure, as read by the sensor (marked green) on the 5 micron filter housing. The number on the right is the high pressure limit. Factory default for the Ventura models is **125 PSI.**

FLOW CONSTANT: The flow constant calibrates the product flow reading. The number on the left is the real time flow reading and the number on the right is the flow constant. The flow constant is set by selecting the desired digit to be changed by pushing the Stop button until the digit to be changed is flashing. Push Auto Run to decrease the value or Auto Store to increase the value. Then select the next digit to be changed with the Stop button. The flow constant is most easily adjusted with the watermaker running with the switch on the control box set to Run Manual. Measure the product flow using a graduated container and a stop watch. Adjust the flow constant until the flow reading matches the measured flow. The flow reading is heavily dampened and will take some time to stabilize after changes are made to the constant. The factory default setting for Ventura models is **25000.**

SALINITY CAL: This window is used to calibrate the salinity sensor. The number on the left is the real time salinity reading and the number on the right is the calibration setting. Increase the setting to raise the reading. The factory default setting for Ventura models is **60.** See **Salinity Probe Calibration** on page 71 for details.

INLET OFFSET: This parameter calibrates the pressure sensor on the inlet side of the black pre-filter housings. This sensor, and its cable, are usually marked with **red** heat shrink tubing. The number on the left is the real time pressure reading and the number on the right is the offset. Factory default for Ventura models is 0. The reading can be increased or decreased by putting a positive or negative number in the offset setting.

OUTLET OFFSET: Outlet offset calibrates the sensor on the outlet side of the black pre-filter housings. This sensor, and its cable, are usually marked with **green** heat shrink tubing. In addition to providing the differential pressure reading, across the pre-filters, this sensor also provides the Feed Pressure reading. The number on the left is the real time pressure reading and the number on the right is the offset. Factory default for Ventura models is **0**.

With new filters installed, adjust the Outlet Offset so the pressure reading (number on the left) is 2 PSI lower than the **Inlet Offset** pressure reading. If the system alarms "Service Prefilters," this means the reading for the pressure differential between the two sensors is exceeding the number programmed under **Pressure Differential**. If the filters are clean and you still receive this alarm, changing the Outlet Offset is the preferred method to eliminate this alarm.

BRIGHTNESS: The brightness is not adjustable on LCD displays supplied with Ventura models, but may be adjusted on Vacuum Fluorescent Displays. Factory default is 0.

FLUSH DURATION: This parameter sets the length of the fresh water flush in minutes. Factory default is 3. This should be the same as Pump On Time.

PUMP ON TIME: Sets the length of time the feed pump will run during the flush. Factory default is 3.

PUMP OFF TIME: Sets the time in minutes that the flush valve is open, but the feed pump is not running, at the beginning and end of the flush cycle. **This function is not used on Ventura models, so factory default is 0.**

FLUSH INTERVAL: This is the time in days between automatic flushes when the system is in Auto Store mode. Factory default is 5 days; 30 days if your system came fitted with the optional Z-Ion. While this parameter is programmed in days, the flush interval countdown timer will read in hours.

MPC 5000 Software may be loaded from www.spectrawatermakers.com or CD ROM, and installed on most Windows-based computers. The computer must then connect to the MPC board with a USB cable with a type B connector on one end, as shown. Due to wide variations in computers and operation systems, Spectra cannot provide installation support, and we only recommend this software for experience technicians. **All parameters and programming can be easily accessed from the MPC display, without this software.**

Type B connector plugged into MPC circuit board

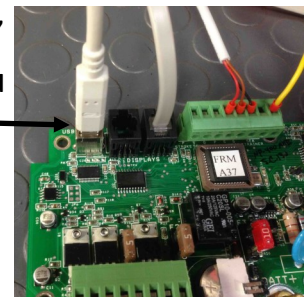

Salinity Probe Calibration

Salinity is a measurement of dissolved solids in liquid. These solids will conduct electricity to varying degrees. A probe with two electrical contacts determines the resistance to the flow of electricity in the liquid. The higher the resistance, the fewer the PPM (parts per million) of dissolved solids. Spectra considers water below 750 PPM to be potable, and water below 500 PPM to be excellent.

The salinity probe is located in the diversion valve manifold, connected to the product water line from the membrane. The salinity probe monitors the salinity level of the product water before deciding to either reject the water and send it overboard, or accept it and divert it into the tank.

The salinity level in PPM can be seen through the remote display.

Using a hand-held tester, note the salinity in PPM of your product water after the unit has been running. Be sure to calibrate the hand-held salinity meter as per the manufacturer's instructions.

Access the Program Mode from the remote display (simultaneously press and hold the Stop and Alarm/Displ buttons for 4 seconds). Press Alarm/Displ to scroll through the menus until you reach the Salinity Cal heading.

The number on the left is the real time salinity reading and the number on the right is the calibration setting. Increase or decrease the setting until the number on the left corresponds to the number acquired from the handheld tester.

Note: Occasionally you may need to calibrate the handheld salinity tester. In order to properly calibrate, a water sample of known salinity must be acquired. These are available from Spectra, part number EL-SLT-CGS8.

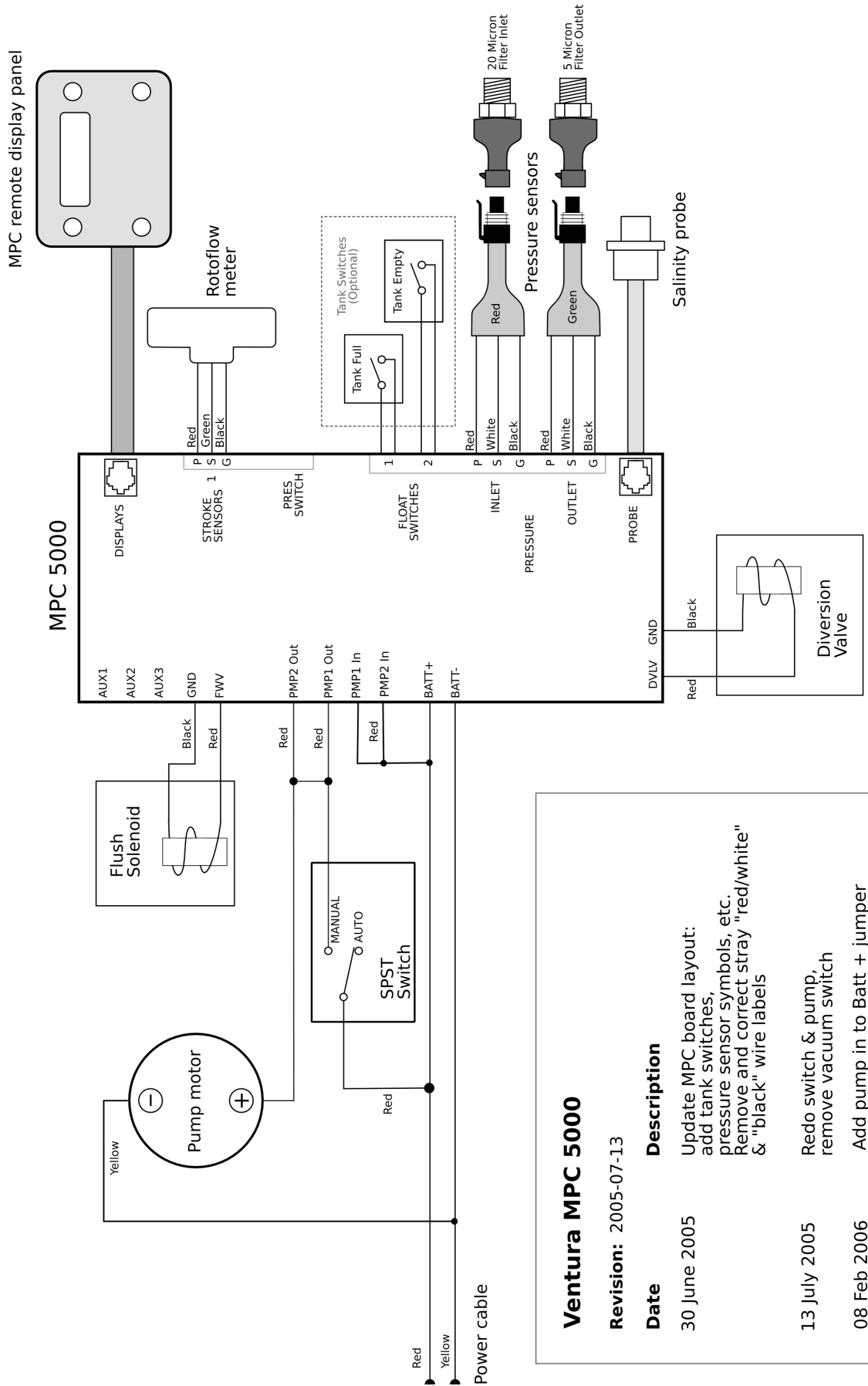

Ventura MPC 5000	
Revision:	2005-07-13
Date	Description
30 June 2005	Update MPC board layout: add tank switches, pressure sensor symbols, etc. Remove and correct stray "red/white" & "black" wire labels
13 July 2005	Redo switch & pump, remove vacuum switch
08 Feb 2006	Add pump in to Batt + jumper Move Motor Ground to Batt-

Spectra Watermakers

MPC 5000 FUSES

The CHECK FUSE alarm indicates that one of the seven fuses on the MPC-5000 Printed Circuit Board has blown. These fuses are the flat, color-coded, small ATM automotive style. The display will indicate by number which fuse has blown, and the fuse bases are numbered on the board. Before replacing the fuse, find and repair the problem that caused the fuse to blow. The fuses supply power to the terminal strip on the PCB as follows:

Fuse F1 5A :	PVLV Priming valve solenoid FWV Fresh water flush valve solenoid
Fuse F2 5A :	AUX 3. Optional boost pump
Fuse F3 10A :	PMP1, Feed pump number 1
Fuse F4 5A :	DVLV, Diversion valve solenoid
Fuse F5 10A :	PMP 2, Feed pump number 2 (not used on Ventura models)
Fuse F6 10A :	AUX 1, Powered when display illuminated AUX 2, Powered during run cycle
Fuse F7 5A :	STER, Powered when feed pump running. Optional ultraviolet sterilizer.

Before replacing fuses, shut off the main power supplies. Remove the lead wire that goes to the affected component from the terminal strip. Using a digital ohmmeter, check the circuits for dead shorts. You should see about 10 ohms or more on the solenoid valve circuits.

On Ventura 150 and 200 systems using Shurflo feed pumps, the pumps are run directly from the board. The Shurflo pumps must be disconnected from the MPC-printed circuit board and tested for current draw using an ammeter or independent circuit breaker.

MCP 5000 Electrical Specifications

Operating voltage limits: 11.6 – 13.8 for 12-volt systems, 23.2 – 27.6 for 24-volt systems

Controller power consumption, mAmp – 700 maximum

Outputs:	BUZZ – 100 mA DC Piezo buzzer. PVLV – 2.5 Amp DC priming valve solenoid. FWV – 2.5 Amp DC fresh water valve solenoid. AUX3 – 5 Amp DC auxiliary output. PMP1 – 15 Amp DC auxiliary water feed pump. DVLV – 10 Amp DC diversion valve solenoid, modulated at 17% duty cycle after 2.5 seconds to reduce power consumption. PMP2 - 15 Amp DC main water feed pump. AUX1 - 2.5 Amp DC auxiliary output. AUX2 – 2.5 Amp DC auxiliary output. STER – 5 Amp DC sterilizer.
-----------------	---

Exploded Views and Part Numbers

Part Numbers

Front View

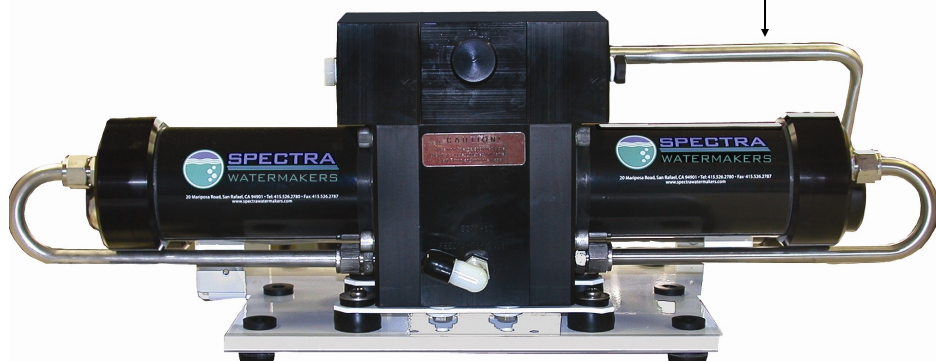

Pump to Pressure Vessel
Upper SS Tube:
PL-TB-HP-HPTVUS

Pump to Pressure Vessel
Upper SS Tube:
PL-TB-HP-HPTVUS

Rubber Mount
HD-RBP-RM
Plastic Spacer
HD-SPN-MKINS

Rear View

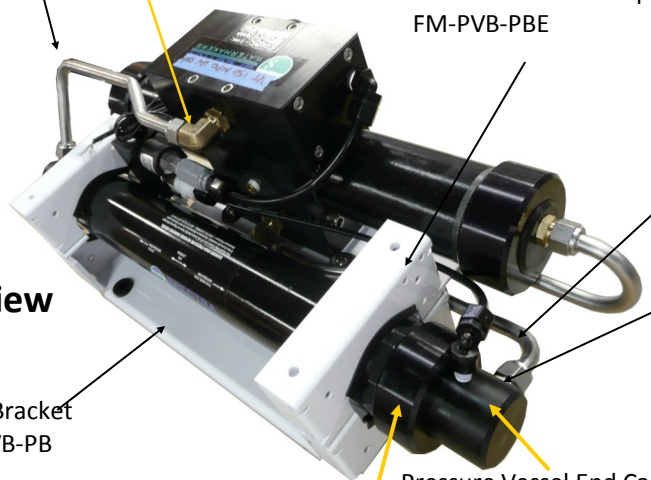

Nickel-Bronze High Pressure
Elbow
PL-MTE-3/4S1/2B

Plate Bracket End Cap
FM-PVB-PBE

Pump to Pressure Vessel
Lower SS Tube:
PL-TB-HP-HPTVLS

Nickel-Bronze High Pressure
Straight Fitting
SUB-MTS-3/8X1/2

Plate Bracket
FM-PVB-PB

Pressure Vessel End Cap
FT-PV-EP

3/4"-16 Straight Thread
O-RING
SO-FT-STF

Pressure Vessel End Ring
FT-PV-ER

1/2" Stainless Ferrule
PL-HWR-1/2FR

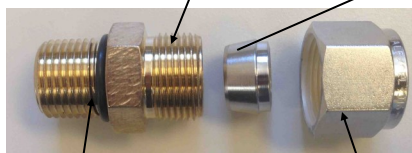

Connector O-RING
SO-HPP-CT

Stainless Fitting Hex Nut
PL-HWR-1/2HN

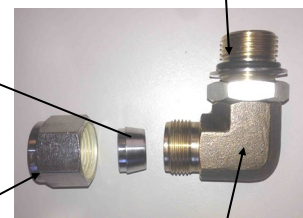

PL-MTE-3/4S1/2B

Part Numbers

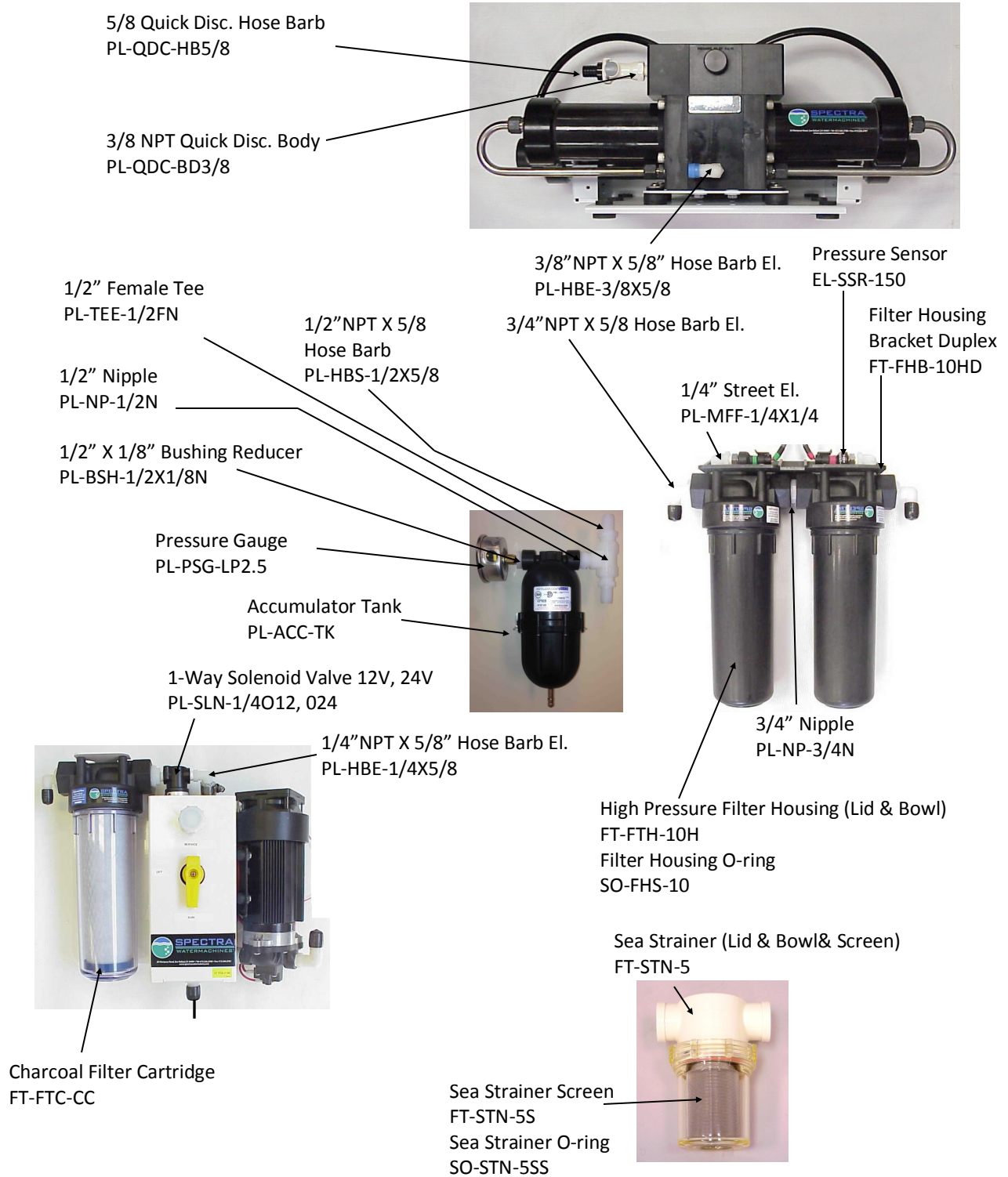

Part Numbers

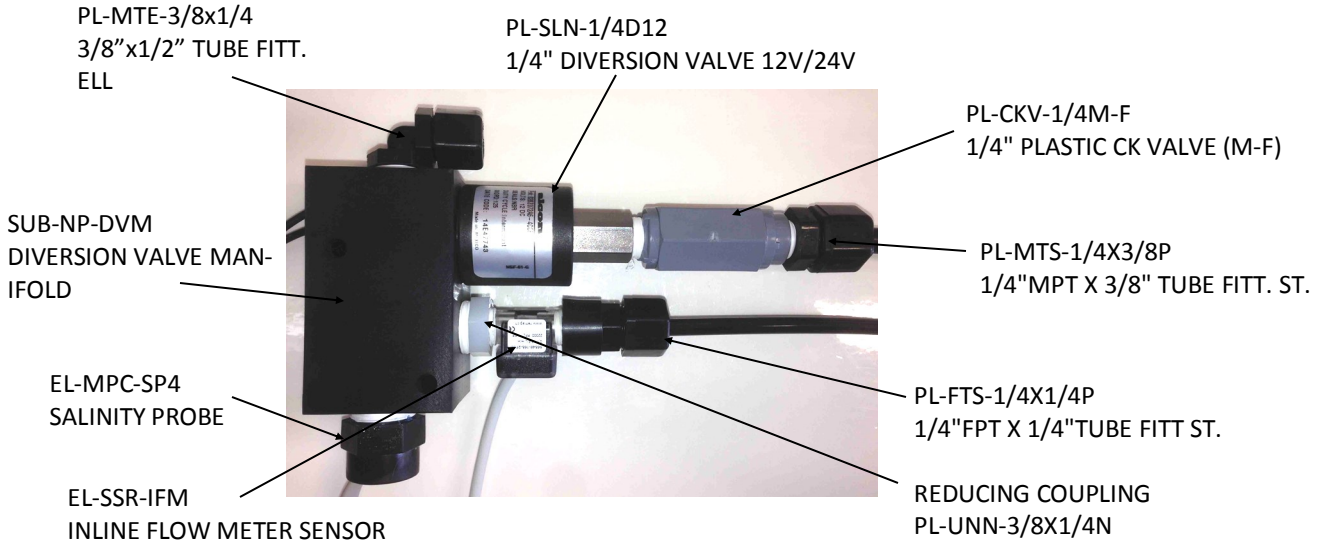

MPC CONTROL PANEL (LCD)
 EL-MPC-RMCD

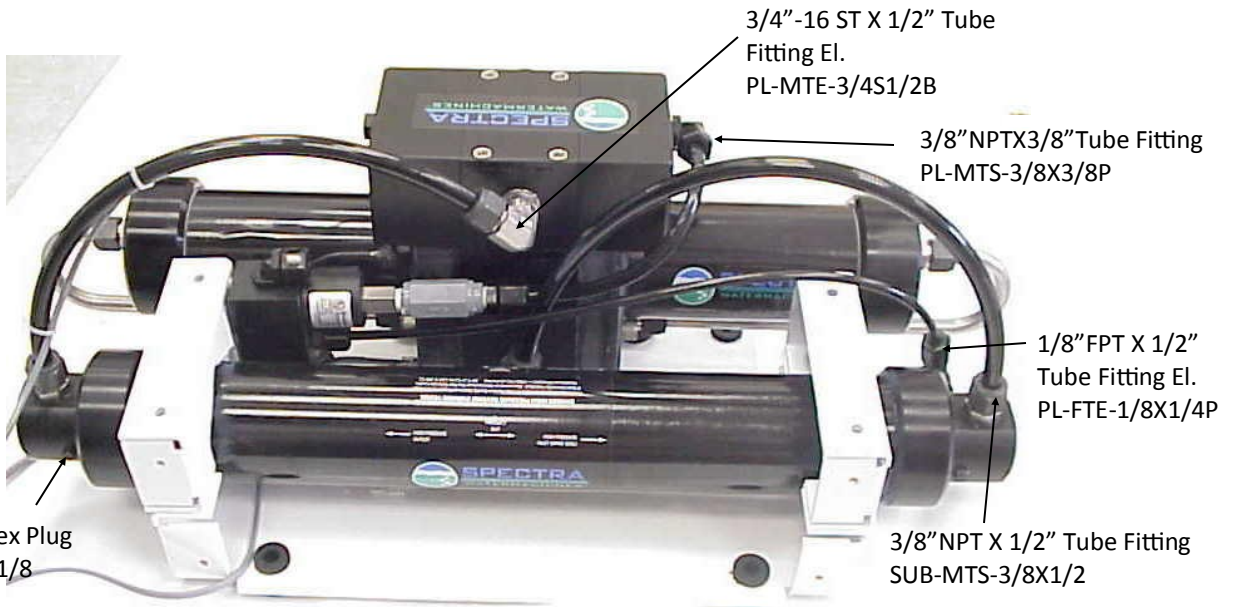

Part Numbers

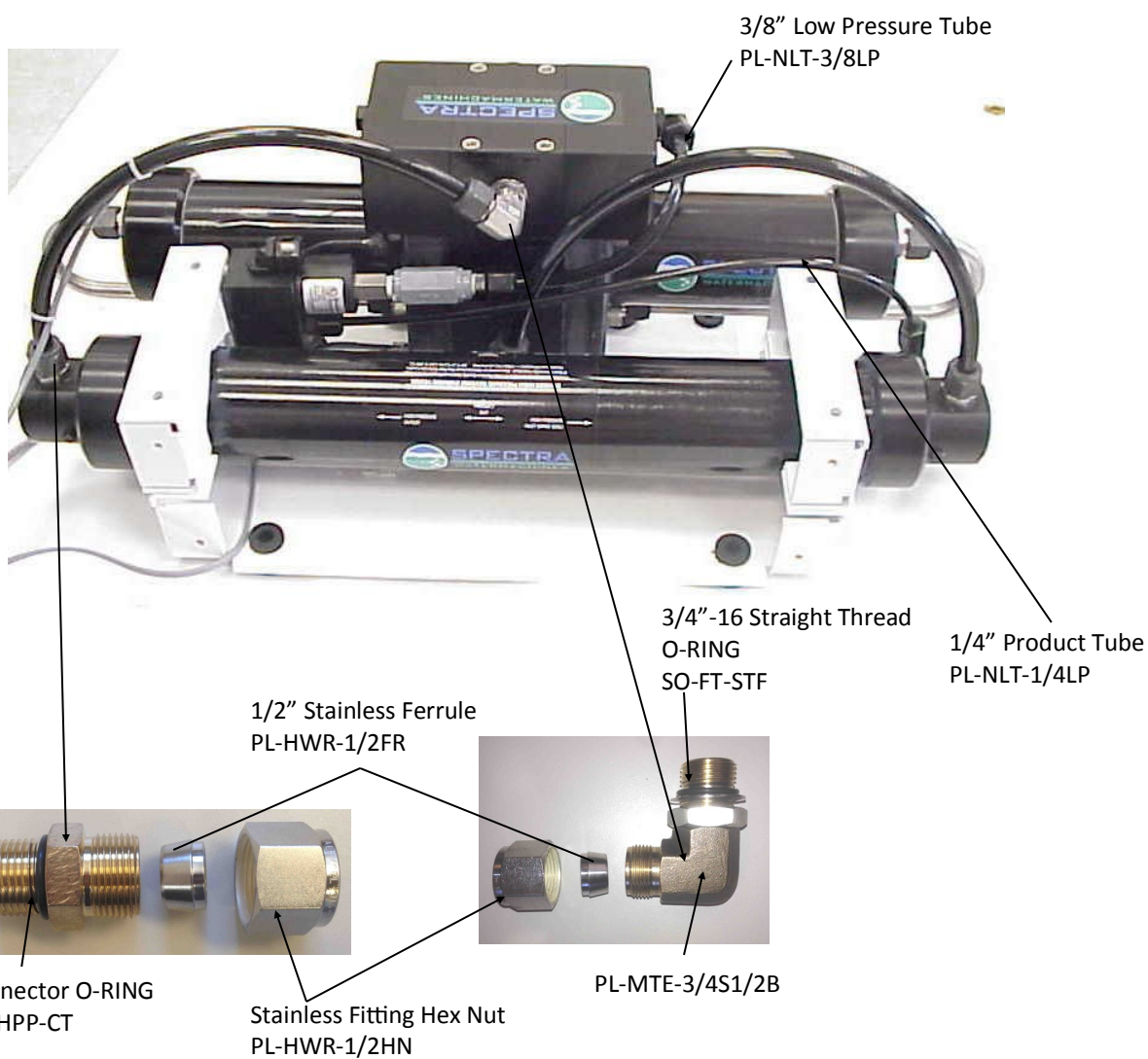
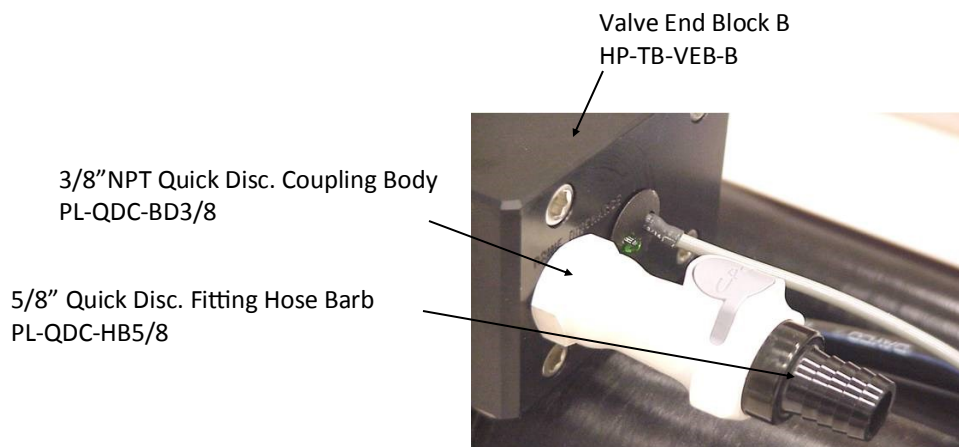

Part Numbers

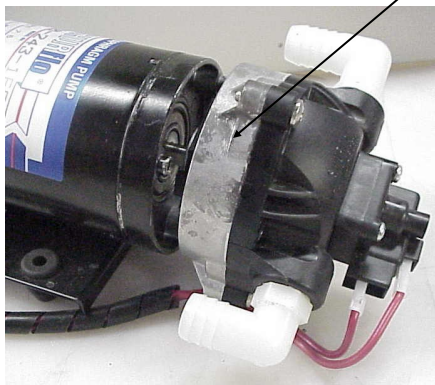
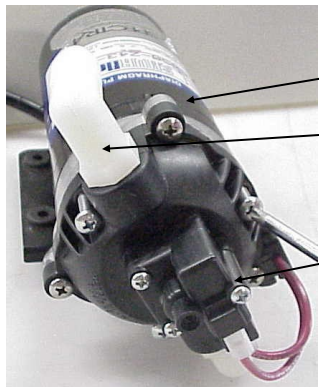

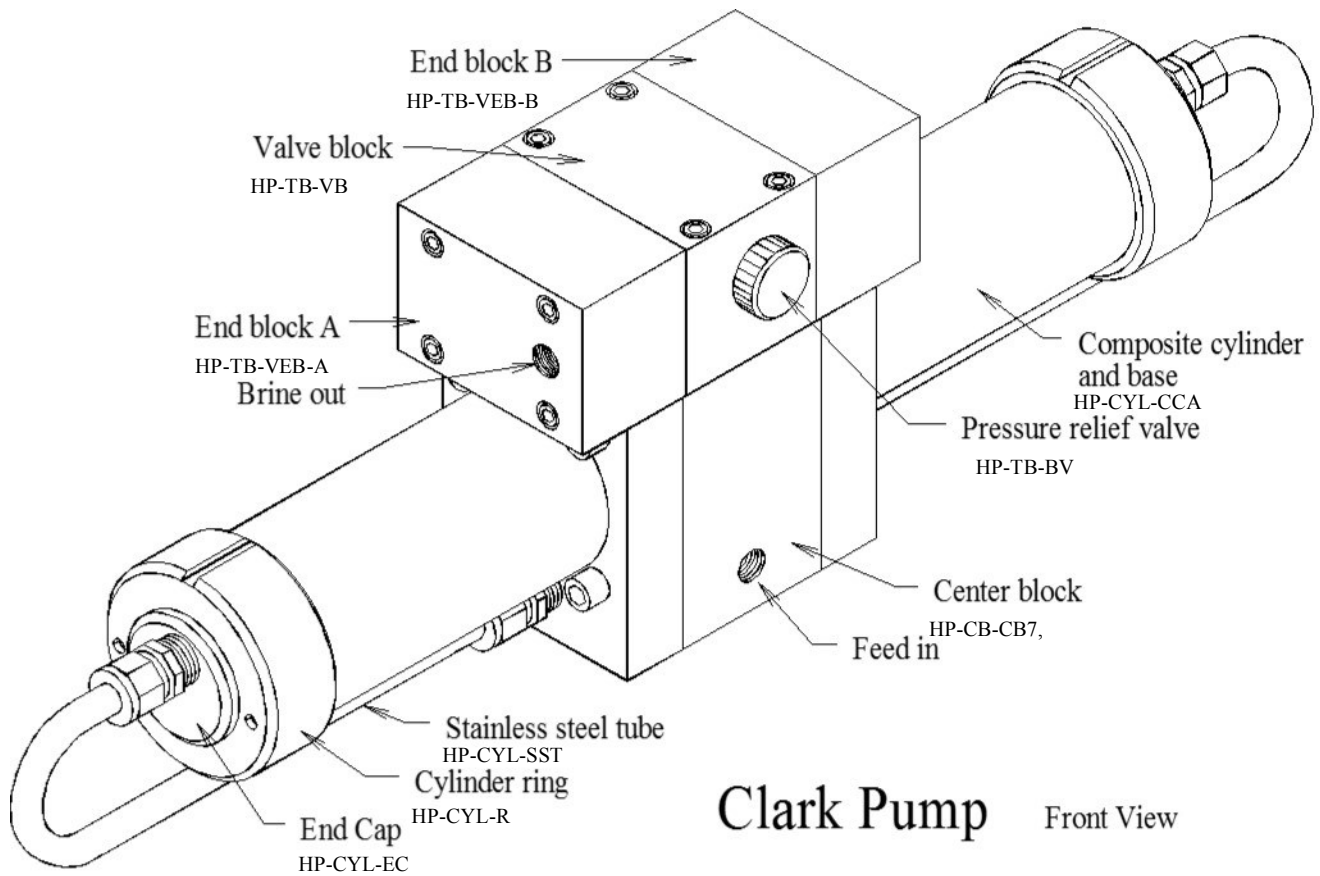

Clark Pump Front View

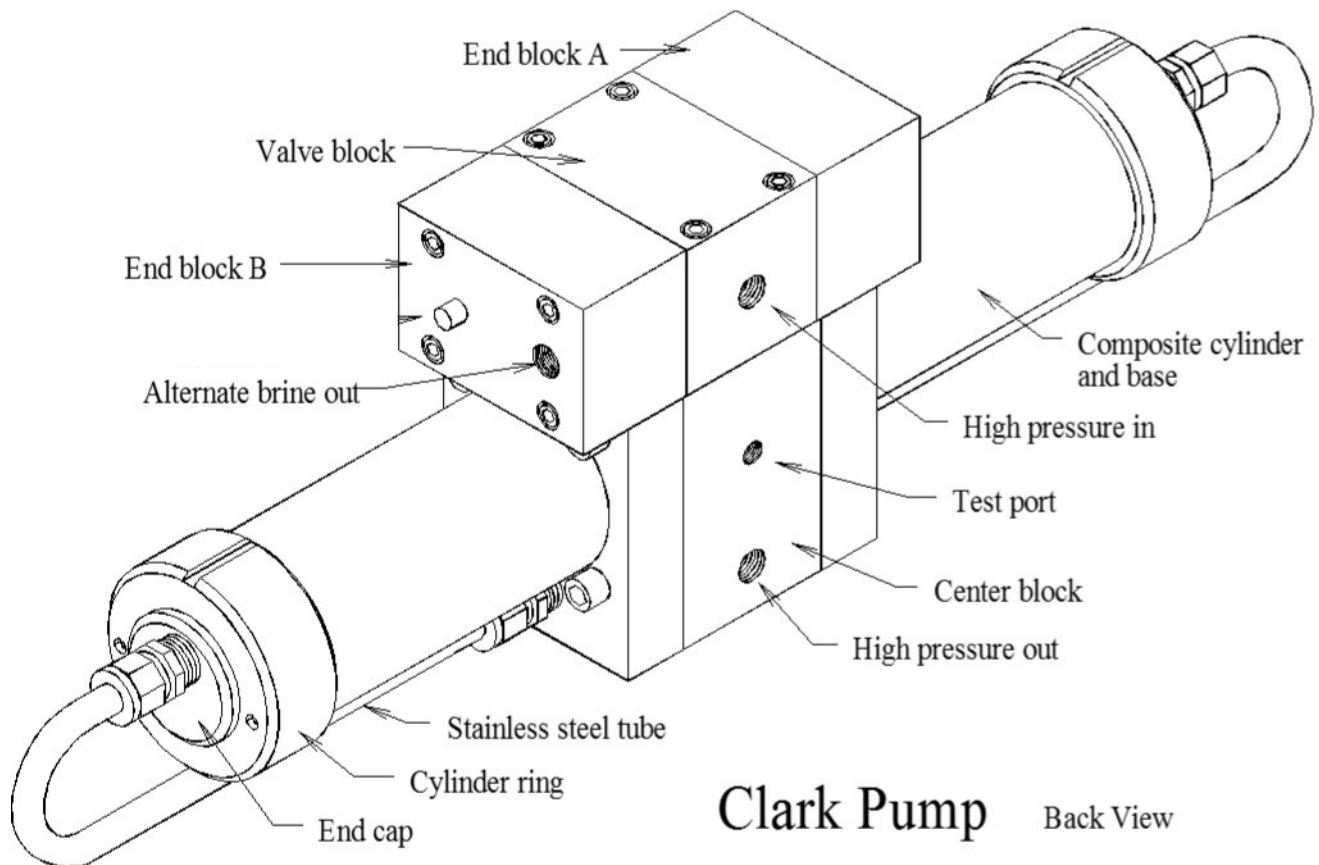

Clark Pump Back View

Spool Assembly Exploded View

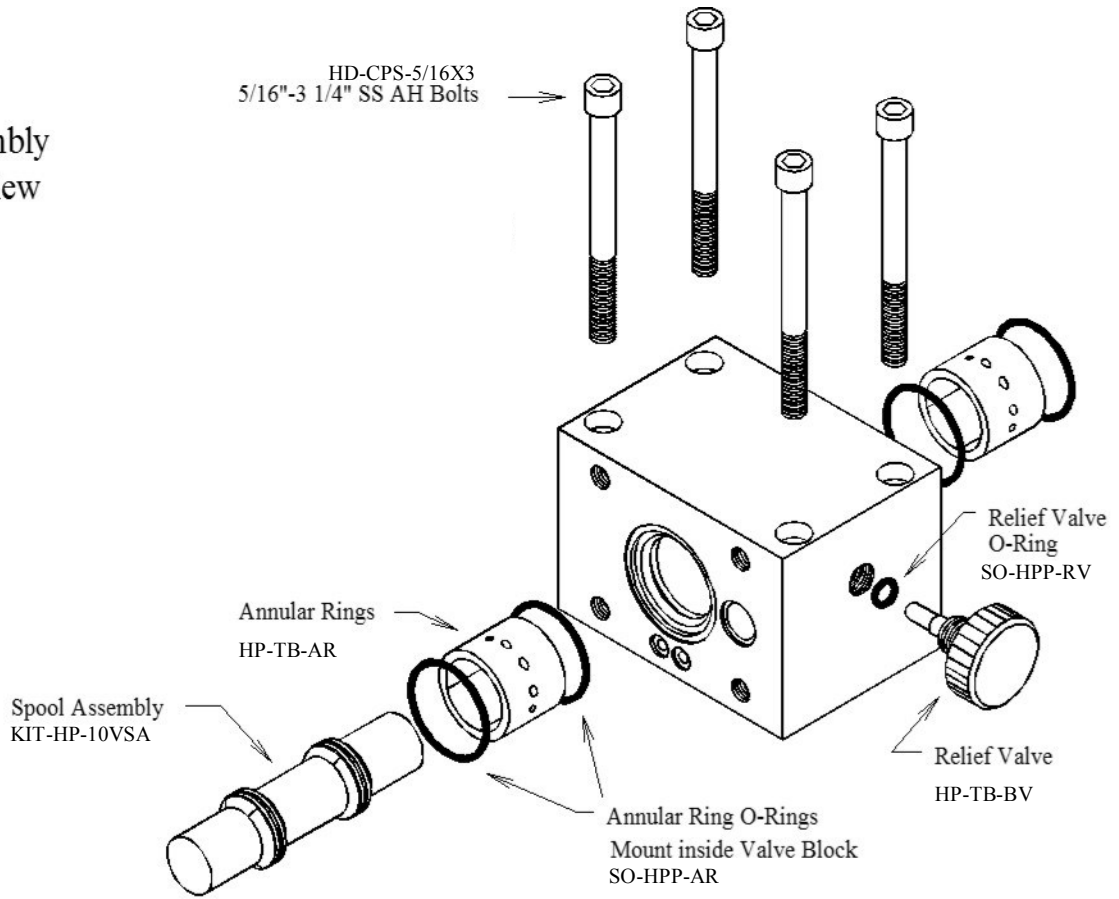

Valve Block

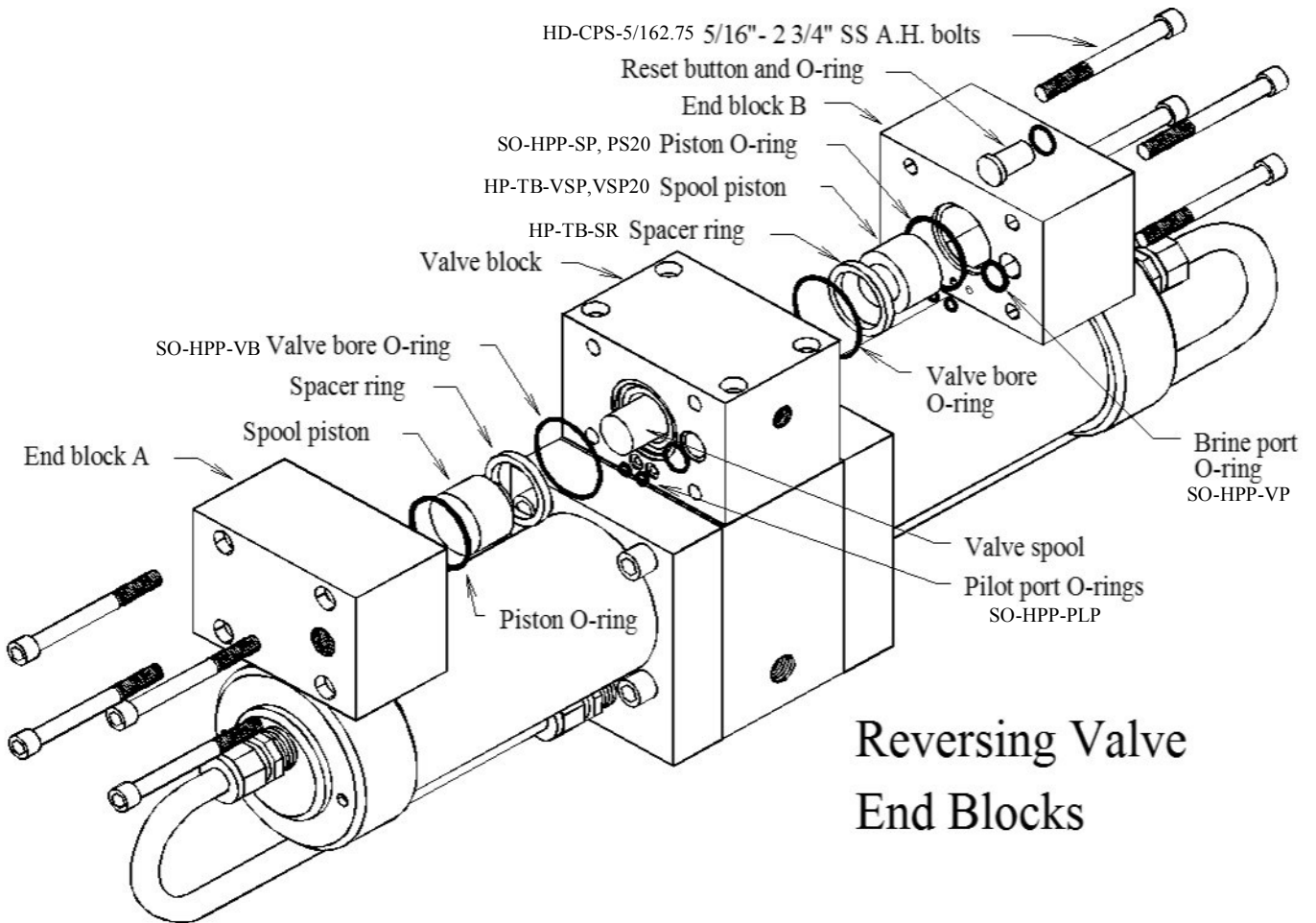

Reversing Valve End Blocks

Parts

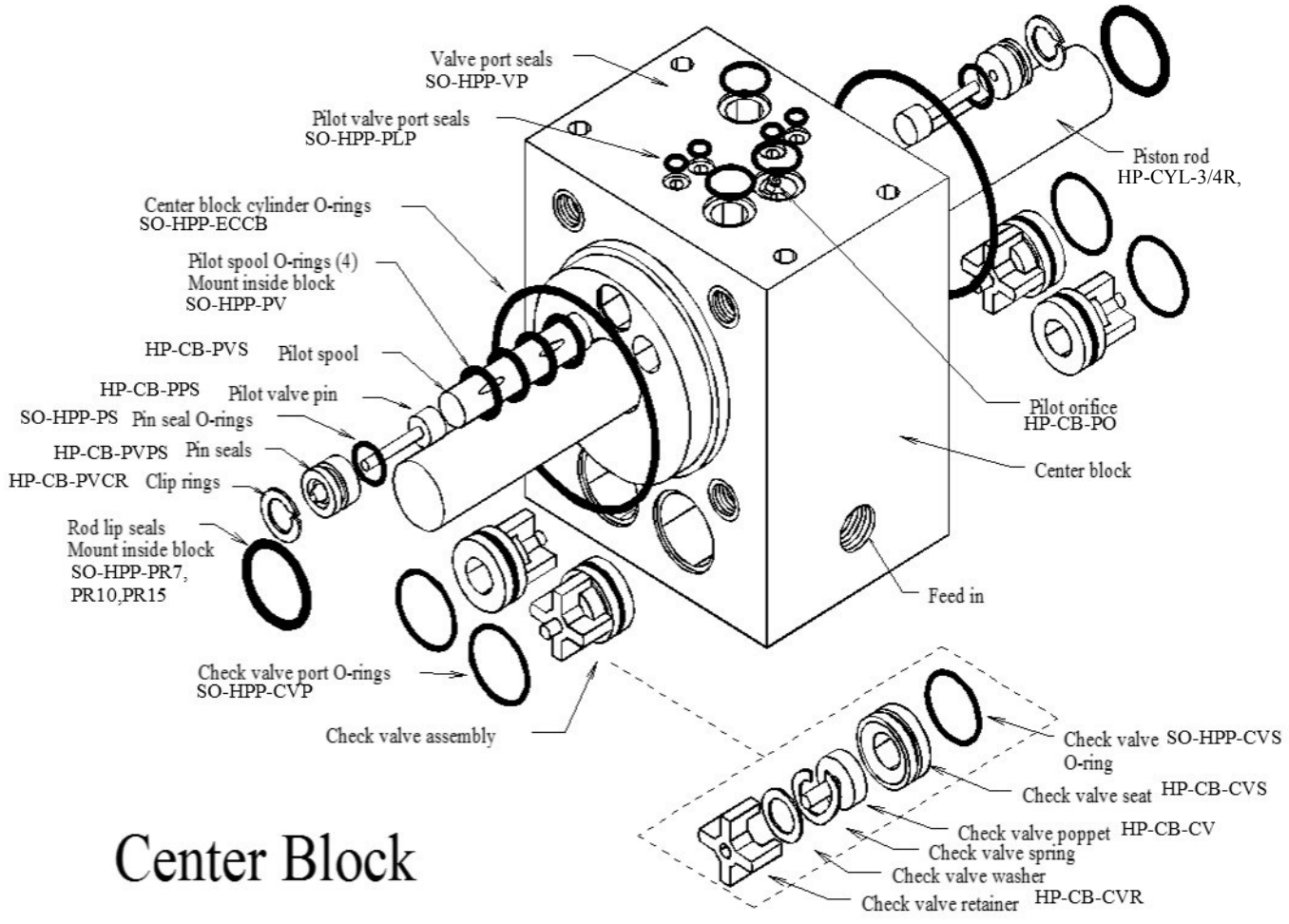

Center Block

Parts

