



Catalina 340R - Remote Manual

Installation and Operating Manual



Spectra Watermakers
Katadyn Desalination LLC.
2220 S. McDowell Blvd Ext. Petaluma, CA 94954
Phone: 415-526-2780 Fax: 415-526-2787
info@spectrawatermakers.com
www.spectrawatermakers.com
Updated January 2024

EXCITING EXTENDED WARRANTY OFFER!

-Upgrade the standard 1-YEAR manufacturer warranty to 2-YEARS and LIFETIME on Clark Pump.

Follow the below steps to submit for approval:

- 1. Have system installed & commissioned by Spectra Authorized FSP (full-service provider)**
- 2. Fill out web-based Product Registration form (see back of owner's manual for paper copy)**
- 3. Complete web-based install/commissioning form (see back of owner's manual for paper copy)**
- 4. Upon satisfactory review of required submissions, your 4-digit system serial number will receive an extra year of warranty coverage, and lifetime coverage on the Clark Pump!**

See 'Extended Warranty' section of owner's manual for full coverage details.

Spectra Product Registration Form

(To be completed by end user/owner)



https://spectrawarranty.formstack.com/forms/product_registration

Spectra Watermakers Commissioning Report

(To be completed by authorized installer)



https://spectrawarranty.formstack.com/forms/spectra_install_commissioning_report



Note: Offer & warranty criteria effective 1/1/2021. For purchases made in the EU, please see 'Expanded Warranty' section of warranty policy in back of the manual for EU specific coverage.

Thank you for your purchase of a Spectra Catalina 340R system. When properly installed and maintained, it will provide years of trouble-free service. Professional installation is strongly recommended. Like any piece of mechanical equipment, the system will require inspection and service, so plan ahead for service access and install “service loops” in cabling. If a dealer is installing the system for you, review the location of the components to ensure the installation will meet your approval upon completion.

Catalina Installation Quick Start Important Details for Installer

1. The system must have a dedicated sea water inlet to guarantee a constant flow of water to the system. The inlet should be as low in the boat as possible with a dedicated, forward-facing scoop-type thru-hull fitting.
2. Both the Catalina 340R feed pump module and the Clark Pump/Membrane module must be installed in a well ventilated compartment where **temperatures will not exceed 113°F (45°C)**. Many engine compartments exceed this temperature when underway. Warranty will be void if the installation does not meet this requirement.
3. Follow the wire gauge charts in the instructions! Using larger wire than specified is acceptable.
4. If you are separating the Clark Pump/membrane assembly, please review the high pressure tube assembly instructions. Improper assembly will cause failure!
5. Run, test, then sea trial the complete system before assuming it is operational. If the boat is in fresh or dirty water, see Dry Testing the System. After testing, make sure the flush cycle operates properly. The water going overboard at the end of the flush should measure <1000 PPM Total Dissolved Solids.
6. The Spectra Remote Manual control must have DC power continuously to achieve the full benefits of the fresh water flush system. The domestic fresh water pressure must be on and the fresh water tank level maintained. Calculate about 7 gallons (27 liters) per flush.
7. The Spectra Remote Manual must be de-powered (DC power off) after the system is pickled or winterized.
8. Spectra dealers are responsible for educating the vessel owners on the operation and maintenance of the system. Please walk through the entire installation with our customer.
9. The equipment owner should fill out the warranty card or register online.



Spectra Watermakers - User Manual Online Access



- Scan QR Code to Visit Spectra Manuals Page.
- Select System, then download the User Manual.
- Reference Commissioning Checklist for important installation requirements.
- Review Installation Basics section of Owner's Manual to ensure warranty compliance.

<http://katadyngroup.ladesk.com/206595-Spectra-Manuals>

Table of Contents

Getting Started	9
Installation Basics	10
Components	11
Catalina Plumbing Schematic & Plumbing Detail	13
Product Water Plumbing and Pressure Gauge Tube Installation	15
Plumbing Detail	17
Tube Fitting Assembly Procedures	19
Electrical	21
Installing A Remote Controller	24
Optional Tank Switch Installation	25
Operation	
New Systems Start Up and Testing	27
Dry Testing with an Artificial Ocean	28
Spectra Remote Manual Controller Guide	29
Freshwater Flush Calibration	30
Adjusting Fresh Water Flush Duration	31
Normal Operation and Fresh Water Flush	32
Nominal Operating Parameters	32
Maintenance, Storage, and Troubleshooting	
Maintenance	33
Introduction to Spectra Chemicals	36
Storage Procedures	38
Winterizing with Propylene Glycol	39
Membrane Cleaning Procedure	40
Suggested Spares	41
Troubleshooting	42
Catalina Flow Test	45
Poor Water Quality	47
Technical Bulletins	48
Spectra Remote Manual Controls	
Wiring Schematic	51
Catalina 340R Electrical Specifications	53
Control Box Wiring	54
Optional Z-Ion Installation and Instructions	55
Exploded Views and Part Numbers	58
Owner Resources	
Warranty, Product Registration, Installation & Commissioning Reports	67

Getting Started

Unpack the system and inspect it for damage during shipping. Freight damage must be reported to the carrier within 24 hours.

Refer to the shipping list for your system to ensure you received all of the components listed. Do not discard any packaging until you have found and identified all of the parts. The small installation parts are listed on the kit list.



We will not be held responsible for shortages that are not reported within thirty days of the ship date.

Study the system layout diagram, component photos, and descriptions before beginning installation.

Lay out the system. Before starting the installation identify where each module and component will be placed. Ensure that there is enough clearance around the components for removal of filters and system service. Make sure you have adequate tubing and hose before starting. Additional parts may be ordered.

Catalina 340R Shipping List:

- Catalina Feed Pump Module
- 10% Clark Pump and Reverse Osmosis Membrane Module
- Boost Pump and Sea Strainer Module
- Fresh Water Flush Module or Optional Z-Ion Upgrade
- Service Kit
- Remote Manual Controller
- 3/4-inch Black Spiral Suction Hose (25 feet)
- 5/8-inch Vinyl Hose (25 feet)
- 3/4-inch Vinyl Hose (10 feet)
- 1/2-inch Vinyl Hose (25 feet) fitted with Quick Connect Fitting on one end, and John Guest stem fitting on the other end.
- 1/4-inch Black Product Tubing (25')

Installation Basics

*Thru-hull
Not Supplied.*



Important Installation Notes



- Avoid tight hose bends and excessive runs.
- Use heavy gauge wire.
- Install feed pump module as low as possible.
- Use a dedicated thru-hull with scoop type strainer.
- Do not mount components over electrical devices.

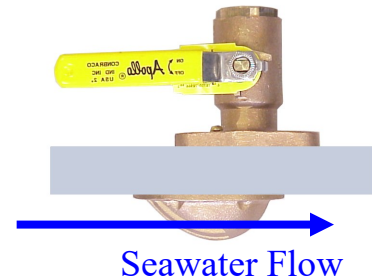

Avoid getting dirt or debris into the piping or hoses during assembly. A

Thru-hull Location: The system must be connected to a dedicated 1/2” to 3/4” forward facing scoop-type intake thru-hull and seacock.

Install the thru-hull intake as far below the waterline and as close to centerline as possible to avoid contamination and air entering the system. Do not install the intake close to, or downstream of, a head discharge, behind the keel, stabilizer fins, or other underwater fixtures.

Thru-hulls in the bow area are susceptible to air intake in rough conditions. Sharing a thru-hull can introduce unforeseen problems such as intermittent flow restrictions, air bubbles, contaminants, and will void the warranty. For racing boats and high speed boats traveling above 15 knots, a retractable snorkel-type thru-hull fitting is preferred because it picks up water away from the hull.

The brine discharge thru-hull should be mounted above the waterline, along or just above the boot stripe, to minimize water lift and back pressure.

Avoid restrictions or long runs on the entire inlet side of the plumbing from the thru-hull to the feed pump module.

Secure the piping away from moving objects such as engine belts and hatches. Prevent chafe on the tubing as required. Test and inspect all piping and hose clamps after several hours of operation.

Pipe Fitting Instructions: To seal plastic-to-plastic fittings, wrap 6 to 8 layers of Teflon tape over their threads. Hold the fitting in your left hand and tightly wrap the threads clockwise. For smoother assembly, do not tape the first (starting) threads.

Wiring

- Pay attention to wire size or system performance will be impaired
- Perform wiring to UL, ABYC, CE or applicable standards

Components

Sea Strainer and Boost Pump Module: Mount close to the intake through-hull, below the waterline, in a location that can handle water spillage during service. The boost pump power cable will connect to the feed pump module.



Fresh Water Flush Module: The fresh water flush module may be located in any convenient location near the feed pump module. It should be mounted with the filter housing vertical and accessible, with 2" of free space below the housing to allow for filter changes. Do not install over electrical equipment. The unit contains the charcoal filter, a solenoid shut off valve, and a flush water flow regulator.



IF INSTALLING THE OPTIONAL Z±ION, SEE Z±ION INSTALLATION INSTRUCTIONS FOR MORE DETAILS.

Feed Pump Module

Mount the feed pump module on a vertical surface, up to 3-feet (1.0M) above the waterline. It is preferable to mount as low as possible. Locate in an area that allows easy access to the filter, and the left hand side of the enclosure. Keep future maintenance in mind when choosing a location, and do not mount above water-sensitive equipment. The feed pump has overheat protection and will not operate properly at ambient temperatures over 113°F (48°C).



Components - Cont.

Remote Manual Controller

The remote control panel can be mounted anywhere dry and convenient. Cut a 5/8" (1.5 cm) wide by 5/8" (1.5 cm) high opening for the display port. The display needs minimum 2 1/2" deep clearance for the cable. Take care not to damage the plugs on the ends of the cable when routing.



Clark Pump and Membrane

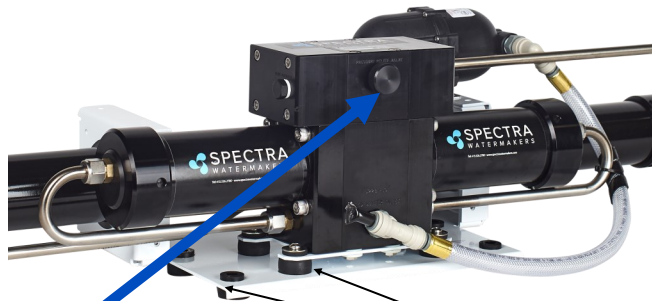

Pressure Relief Valve

Double rubber mounts
to absorb vibration

This module must be installed in an area that maintains a temperature below 113°F (45°C). It may be placed as high in the boat as you desire, and mounted in any position, even upside down. Make sure that the area around and under the pump does not have any water sensitive equipment, as water will be spilled during any repairs or if a leak occurs. Allow for easy access to the pressure relief valve.

The Clark pump and membrane module comes complete with a mounting system. Be sure to use the supplied washers on the rubber feet.

Simplified Plumbing Layout



Mount Controller in a dry location well above the waterline.

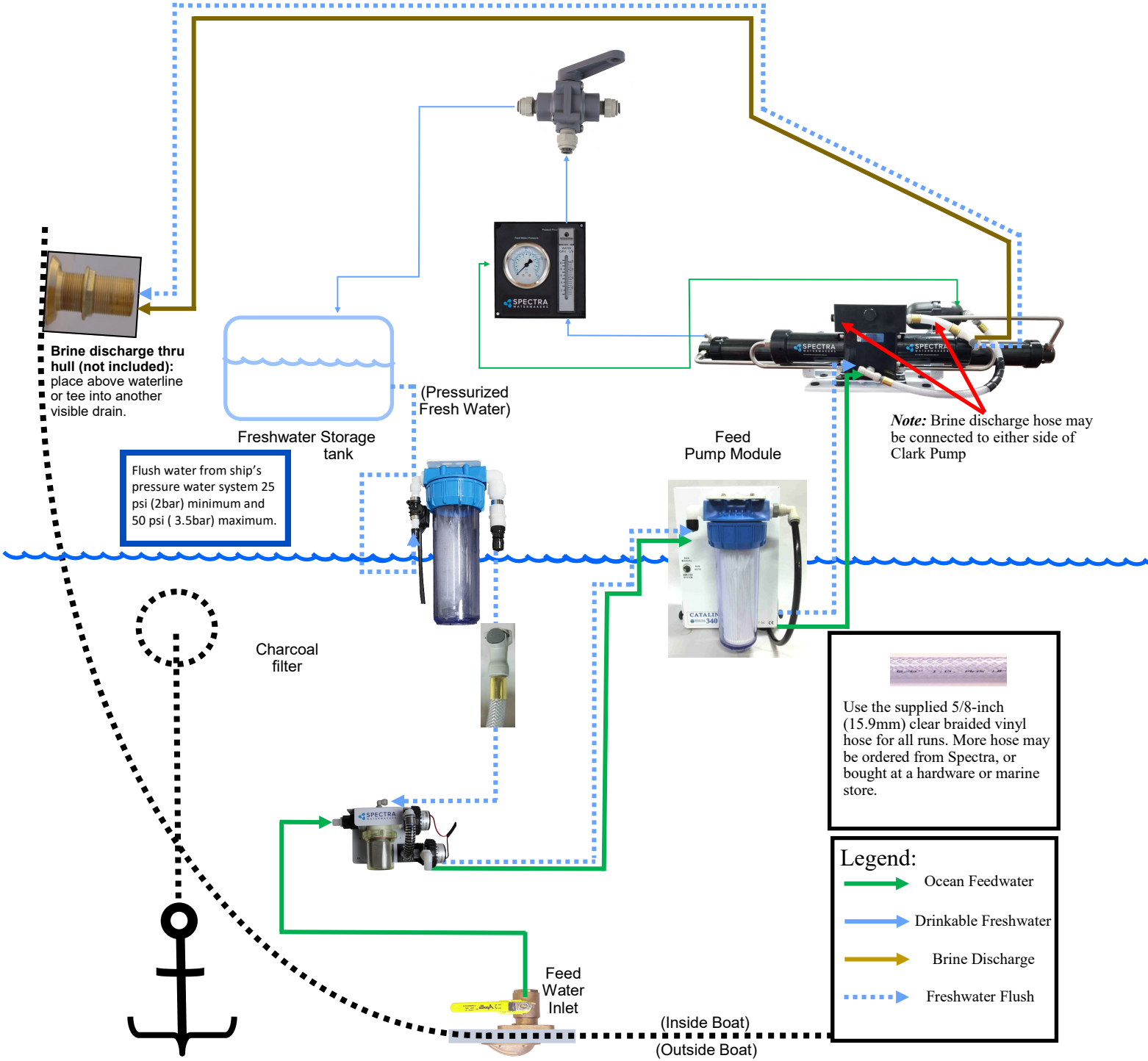

Use the supplied 5/8-inch (15.9mm) clear braided vinyl hose for all runs. More hose may be ordered from Spectra, or bought at a hardware or marine store.

Legend:

- Ocean Feedwater
- Drinkable Freshwater
- Brine Discharge
- Freshwater Flush

Installation Notes

Product Water Plumbing and Pressure Gauge Tube Installation

Sampling Tap for testing the product water.

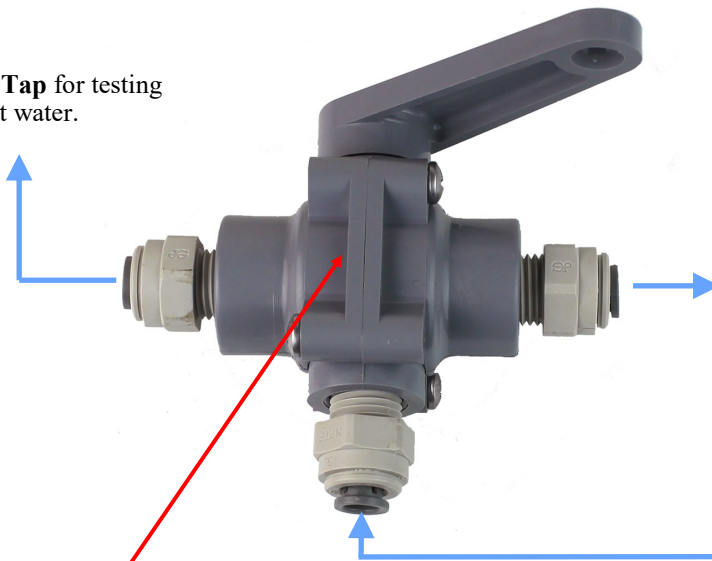

Product to tank: Route the product water from the valve into the top of a vented tank. Install a tee in the water fill or tap a pipe thread into an inspection port.

⚠ DO NOT! feed the product into a vent line, manifold, or the bottom of the tank. Make sure that there is no restriction in this piping. **Pressure in the product tubing must never exceed 5psi (.3bar)**, running or stopped, or the membrane will be permanently damaged.

Product Sampling Valve: Mount using the supplied plastic straps. **Note: the handle points in the direction of flow.**

(Back view of instrument panel)

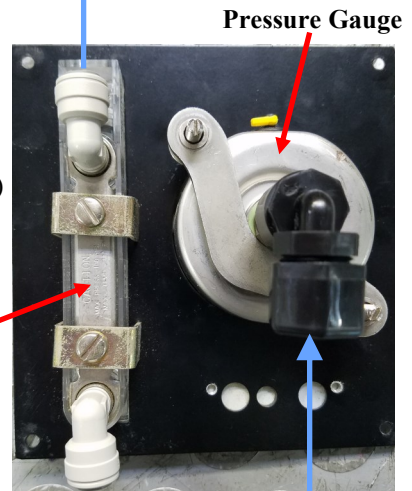

Use accumulator port to connect to the pressure gauge with the supplied 1/4" black nylon tubing. Tubing must be pressure rated to 150 PSI (10 BAR).

Product Flow Meter

Pressure Gauge

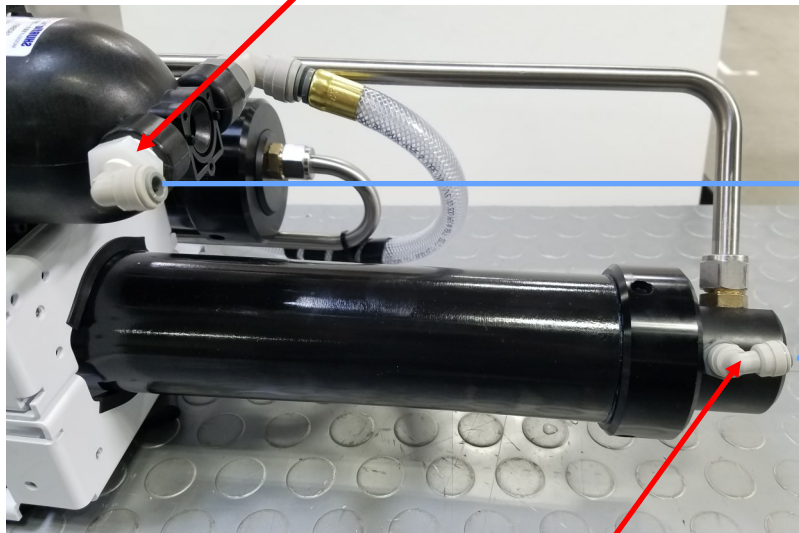

Use the supplied 1/4" blue tubing for the product water plumbing.

Product output fitting.

Product Water Plumbing and Pressure Gauge Tube Orientation

The black 1/4" tubing runs from the accumulator to the Feed Pressure Gauge. Locate an optimal location close to the Clark Pump for viewing and mounting the Product Water Flowmeter & Feed Pressure Gauge Panel and then cut the provided black 1/4" tubing accordingly.

Take careful consideration where to mount the Product Sampling Valve so that the blue 1/4" product water tubing can reach from the High Pressure Vessel to the Product Water Flowmeter, then to the Product Sampling Valve, and then splitting off to the Sampling Tap to test the Total Dissolved Solids (TDS) in the product Water, as well as the Freshwater Storage/Flush Tank.

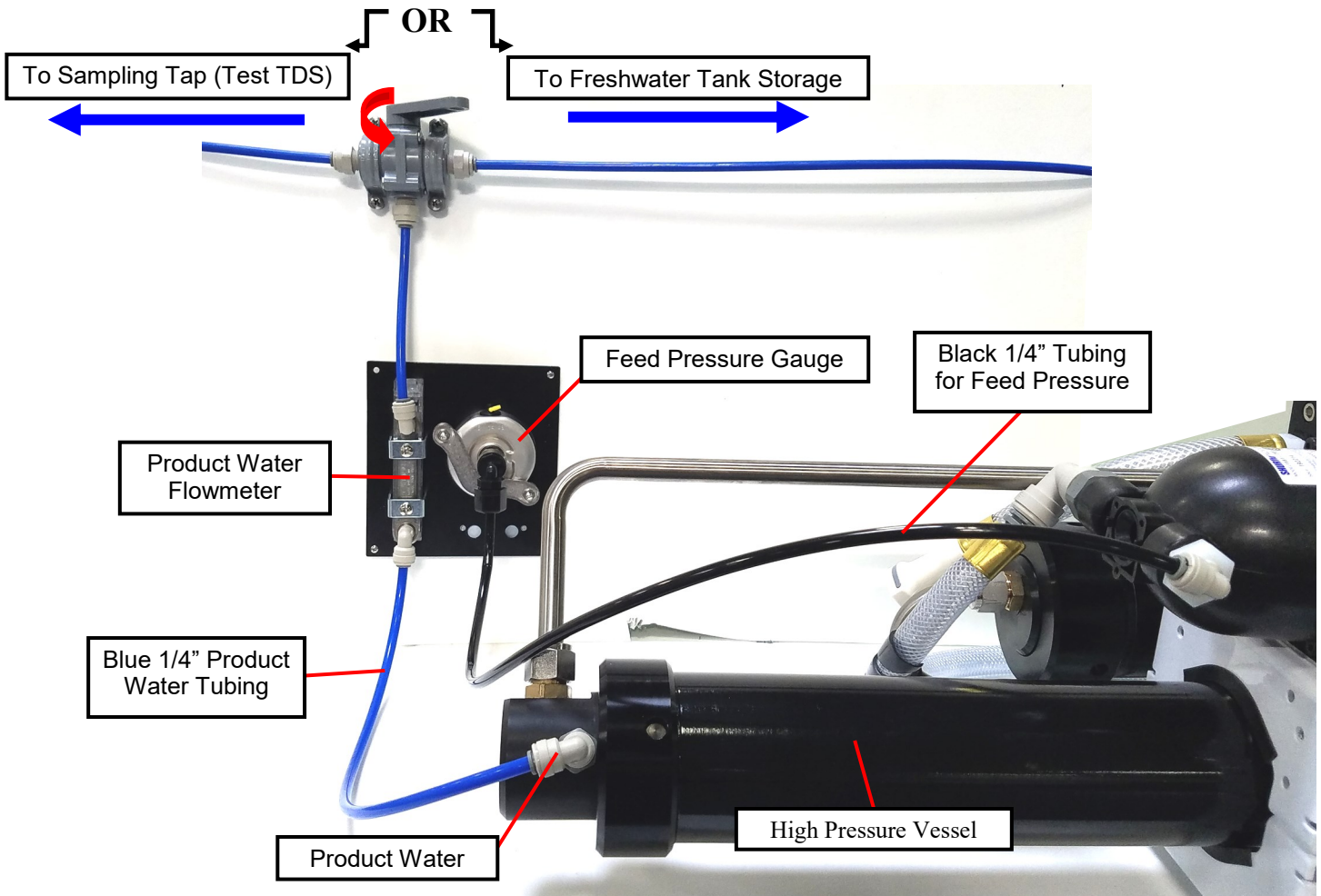

Note: The orientation of subassemblies shown above are not to scale and installation will vary from vessel to vessel. Ensure that tube runs are set up in this orientation, although length of runs will vary based on where the Clark Pump and High Pressure Module are mounted in relation to the other sub-assemblies.

Plumbing Detail

From the intake seacock to the sea strainer/boost pump module, and from the sea strainer/boost pump module to the prefilter housing on the feed pump module, use the 3/4" black, spiral-wound suction hose:



Your system includes 25-feet of 1/2" vinyl hose with a Quick Connect fitting on one end and a 1/2" John Guest stem fitting on the other, both crimped on with ferrules. You will **CUT THIS HOSE** and, using the fittings found in the installation kit, use one end for the feed water inlet hose and the other for the fresh water flush hose:



Fresh Water Flush: Route a feed line from the domestic cold pressure water system to the 1/2" hose barb on the fresh water flush module. This needs to be pressurized for the fresh water flush system to function properly. *The domestic fresh water pump must be able to deliver 1.5 gallons per minute (6 LPM) at 25 PSI (1.7 bar).* Note: Never leave system unattended during a flush cycle. Once cycle is complete system will still draw power in a standby state until user manually pushes the 'Stop' button on the controller.

Flush water from ship's pressure water system 25 psi (2bar) minimum



If purchased, the optional Z-ION replaces the Fresh Water Flush Module



Attaching 1/2" vinyl hose to Z-Ion/ fresh water flush module with the pre-fitted Quick Connect fitting:



Attaching 1/2" vinyl hose to sea strainer using the 3/8" John Guest stem fitting and hose clamp found in installation kit:



Plumbing Detail - Cont.

From the feed pump to the Clark Pump feed water inlet, use the remaining 1/2-inch vinyl hose, with the 1/2-inch John Guest stem fitting pre-fitted with a ferrule. Insert the pre-fitted end into the feed pump (Figure 1), and the **1/2"** John Guest stem fitting and hose clamp from the installation kit for the Clark Pump feed water inlet (Figure 2). Refer to John Guest assembly instructions.

Figure 1:

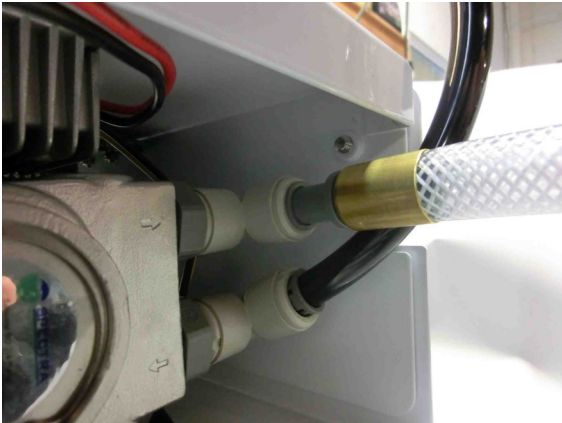

Figure 2:



Brine Discharge: Route the brine discharge from the quick disconnect fittings to a thru-hull above the waterline using the supplied 5/8" braided vinyl hose and the male Quick Disconnect fitting from the installation kit:



Quick Disconnect Fitting

Fast & Tite® Thermoplastic Fittings

Fast & Tite® fittings are the most complete line of plastic fittings for thermoplastic tubing in the industry.

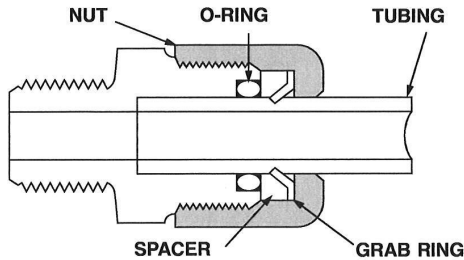

Fast & Tite® thermoplastic tube fittings from Parker will prove to be the answer to your tubing connector needs. Patented Fast & Tite® fittings install in seconds without tools and provide a tight, sure, leak proof seal without clamps or adjustments. A unique 302 stainless steel grab ring for tube retention, coupled with a Nitrile O-Ring for positive seal, assures good tube connection with only hand tight assembly. A plastic grab ring is also available upon special request. Vibration or tube movement will not break the seal and cause leakage. Preassembled in either highly inert polypropylene, or strong, durable nylon, Fast & Tite® fittings are the answer to full flow thermoplastic tubing system requirements. When necessary, Fast & Tite® fittings can be disassembled by hand for fast system drainage. Fittings are completely reusable.

Parts are easily replaced. O-Rings are standard size and universally available. (For applications requiring other than Nitrile O-Rings, consult your Fast & Tite® distributor.)

Use Fast & Tite® fittings with Parker Parflex tubing or other plastic, glass or metal tubing for low pressure or vacuum lines up to the pressure limits shown below.

Fast & Tite® fittings meet FDA and NSF-51 requirements for food contact.

Working Pressures for Fast & Tite® Fittings

Tube O. D., in.	Air-Oil-Water Pressure in PSI		
	Up to 75°F	76° to 125°F	126° to 175°F
1/4	300	300	300
5/16	300	300	300
3/8	250	250	150
1/2	200	200	150
5/8	150	100	50

Ratings are based on use with copper tubing, and in all cases represent the maximum recommended working pressure of the fitting only. Working pressures (vs. temperatures) of other types of tubing may limit the tube and fitting assembly to pressures lower than shown above. Consult factory for recommendations on applications other than shown above.

Temperature Range:

Black/White Polypropylene: 0°F (-18°C) to +212°F (+100°C)
White Nylon: -40°F (-40°C) to +200°F (+93°C)

Fast Assembly

Step 1.

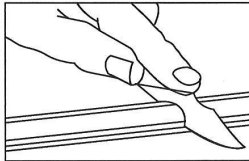

Cut the tube squarely and remove any burrs.

Step 2.

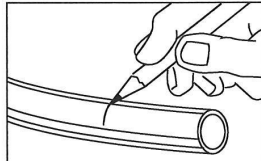

Mark from end of tube the length of insertion. (See table below)

Tube O.D. (in.)	Insertion Length with Tube Support (in.)	Insertion Length without Tube Support (in.)
1/4	5/8	9/16
5/16	5/8	9/16
3/8	13/16	3/4
1/2	7/8	13/16
5/8	1	15/16

Step 3.

Loosen nut on fitting until three threads are visible. Fittings for glass tubes must be disassembled and the grab ring removed.

Step 4.

Moisten end of the tube with water. Push the tube **Straight** into fitting until it bottoms on the fitting's shoulder. Tighten nut by hand. Additional tightening should not be necessary, but 1/4 additional turn may be added if desired. **Do not overtighten** nut as the threads will strip and the fitting will not function properly. A proper assembly will not show the insertion mark extending beyond the nut. If the insertion mark is visible, then steps 1 thru 4 must be repeated.

Step 5.

When using clear vinyl tubing or urethane tubing, it is necessary to use a **TS** tube support. Disassemble the fitting and place the nut, grab ring, spacer and tube support, in that order on the tube. Locate the grab ring at the insertion mark as shown. Seat the O-ring in the body, then proceed with Step 4.

Note: Provide adequate fail-safe mechanisms such as leakage detection sensors, automatic shut-off controls or other industry and code appropriate fail-safe devices in the design of your water-handling appliance to protect against personal injury and property damage.

Plastic fittings containing an o-ring that are used in water applications should be replaced at least every five years or more frequently depending on the environment and severity of the application.

John Guest Super Speedfit Fittings

How Super Speedfit Works

To make a connection, the tube is simply pushed in by hand; the unique patented John Guest collet locking system then holds the tube firmly in place without deforming it or restricting flow.

Materials of construction

Super Speedfit fittings are made up of three components:

Bodies are produced in an acetal copolymer or polypropylene.

'O' rings are Nitrile rubber or EPDM.

Collets are produced in acetal copolymer or polypropylene with stainless steel teeth.

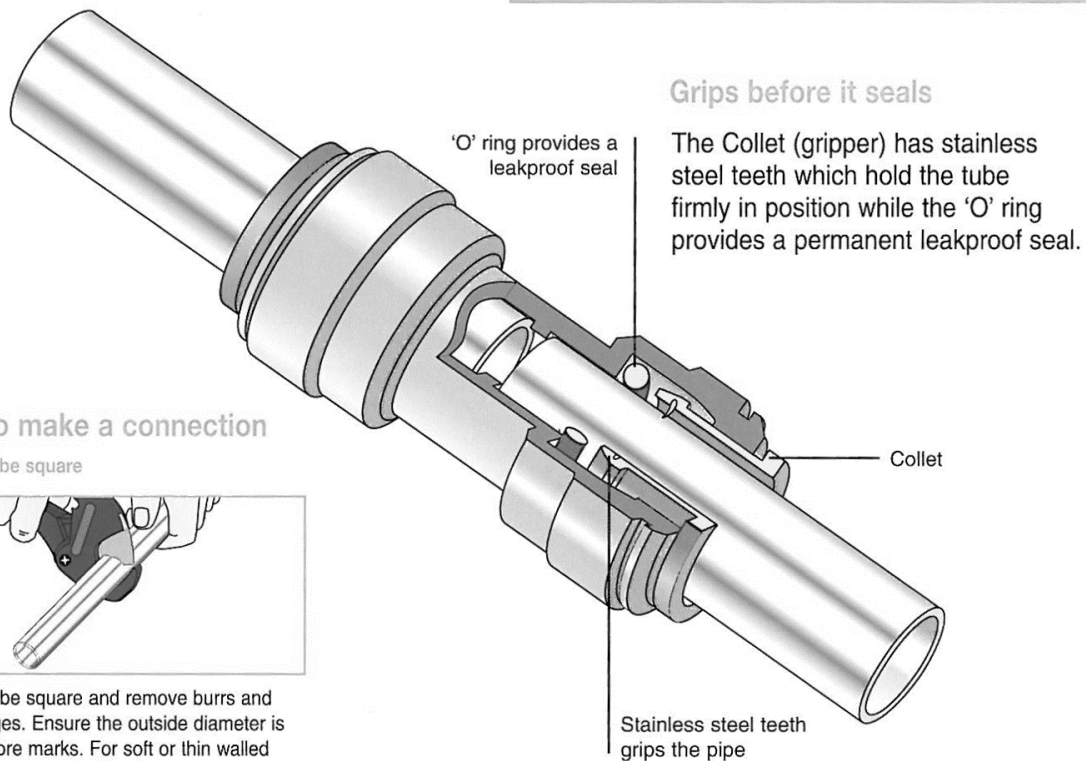

How to make a connection

Cut the tube square

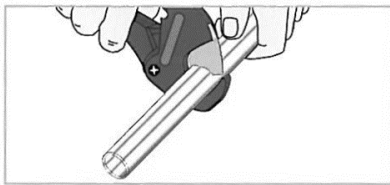

Cut the tube square and remove burrs and sharp edges. Ensure the outside diameter is free of score marks. For soft or thin walled tube we recommend the use of a tube insert

Push up to tube stop

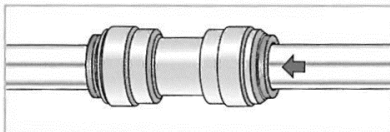

Push the tube into the fitting, to the tube stop.

Pull to check secure

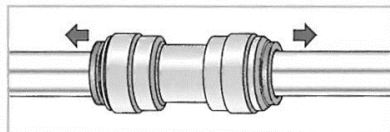

Pull on the tube to check it is secure. Test the system before use.

To disconnect

Push in collet and remove tube

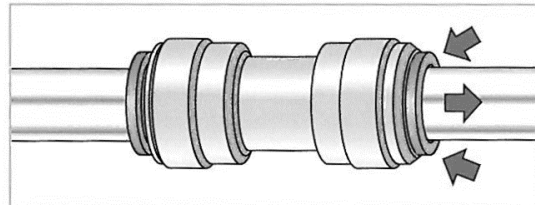

To disconnect, ensure the system is depressurized, push the collet square against the fitting. With the collet held in this position the tube can be removed.

Electrical

Catalina 340R systems are pre-fitted with waterproof connectors for electrical and signal cables. Each connector is different, so it is impossible to connect them incorrectly, and the connectors are color-coded. The system has a power inlet harness with a terminal block and cover, a 2-conductor boost pump cable, a 2-conductor fresh water flush solenoid cable, a Z-Ion power and signal cable, and a 25-foot (7.62M) cable for the Remote Manual Controller.

The Catalina 340R has a power inlet harness with a terminal block and cover, a boost pump power plug with a yellow band, terminal block for the tank full switch and the optional tank level sensor, and a short plug with a green band for the optional Z-Ion.

Do not install it in hot or poorly ventilated locations. Allow access to the motor speed control.

Cables are shown coming out of the bottom of the Feed Pump Module.

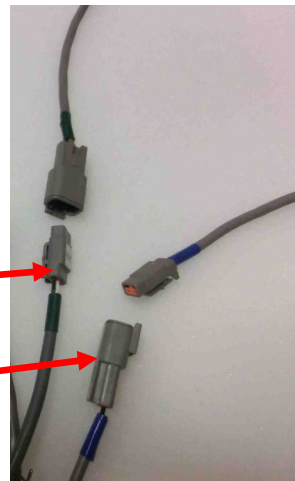

Z-Ion power and signal cable (3-conductor, Green)

Fresh water flush solenoid cable (2-conductor, Blue)

Spectra Remote Manual Circuit Board (Inside control box)

Motor speed controller



Run Auto/Manual/Service toggle switch



Electrical - Cont.

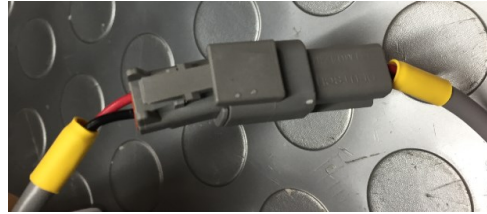

Connect the yellow boost pump connector from the bottom of the feed pump housing to the corresponding connector routed from the boost pump.



Mount the main power terminal block in a junction box or on a bulkhead adjacent to the feed pump module. Make sure that this is a dry location well above bilge level and not subject to water spray. **Be sure to install the terminal block cover.**

Check the wire size chart for appropriate wire sizes. DC power feeds should be uninterrupted to insure proper operation of the auto store feature. Avoid house breaker panels that could be accidentally tripped.

Component Sizing:

- 12-Volt: Use a 32A-35A breaker and size the wiring for 25 Amperes.
- 24-Volt: Use a 15A breaker and size the wire for 13 Amperes.
- Provide circuit protection at the source! Undersized wiring will reduce system performance.

Wire Size Guide for the Catalina 340R 12 Volt:

8 Gauge (10mm²) up to 15 feet (4.5M)

6 Gauge (16mm²) up to 20 feet (7.6M)

4 Gauge (25mm²) up to 35 feet (14M)

Distances at left represent the total ROUND TRIP wire length (DC positive length plus DC negative length), NOT the length of the pair of wires together. Size cables accordingly.

Note: All wiring to be done to applicable ABYC, Marine UL, or CE standards.

Electrical - Cont.

The Catalina 340R has one port that can be viewed when looking down inside the Feed Pump Module. This port is labeled 'Display' but is actually for the Remote Manual Controller. The Remote Controller cable is a standard Cat 5e ethernet cable.



25' (7.62M) cable with connectors for the Remote Manual Controller



Installing a Remote Controller



Route the cable through the vessel in the most direct route possible. Avoid kinking the wire, or sharp corners where the wire can chafe through while the vessel is under way.

Turn power OFF to the system.

Connect the ethernet cable to back of the display in the open jack.

Connect the opposing end of the ethernet cable to the RJ45 port labeled "DISPLAY" in the feed pump module.

Remote Controller Plugin



Optional Tank Switch

The customer supplied float switch must be connected to the **Terminals 5 & 6** labeled **Tank Full** within the Control Box that is mounted to the inside of the Feed Pump Module. There is no polarity. Remove the jumper. Connect the wires to the terminals. **Use 18/2 tinned wire or larger. Wire is not included in the installation kit.**

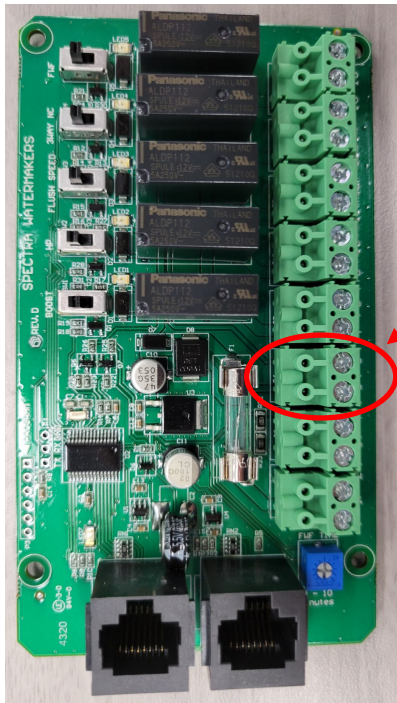

Connect to
Terminals 5 & 6



Top-Mounted

OR



Side-Mounted

Note: Remove **only** the jumper in terminals 5 & 6.

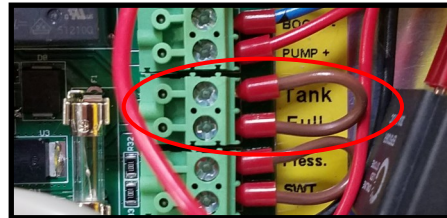

WARNING *Your watermaker should never be left running unattended.*

Watermakers should never be run unattended.



Tank Full

If a tank switch has been installed, the "Running" and "Stopped" lights will be illuminated when the tank is full and the system will stop.

Optional Tank Switch - Cont.

Customer-Sourced Tank Full Switch

Installing an optional tank full float switch at the top or the side of your water tank allows the watermaker to fill your ship's water tank then automatically stop running. The user can then fresh water flush the system by hitting 'Stop' and then 'FWF' on the Remote Controller.

Your watermaker **does not** come with the top-mounted Tank Full Switch (EL-SWT-LV). However, this part can easily be sourced from your local dealer or Full Service Provider if you wish for your system to automatically stop once your freshwater tank is full.

If you do not install the Tank Full switch in your tank, you MUST MANUALLY STOP the system when your freshwater tank has been filled. The system will not stop automatically.

Note: The float may need to be flipped 180 degrees to work properly. Many floats can be easily flipped by removing the clip opposite the wire.



Drill and tap a 1/8" NPT port into the top of the fresh water tank if using a top-mounted float switch or into the side of the tank if using a side-mounted float switch. A top-mounted float can be installed on a tank access cover, or directly into the water tank. If installing on an access cover, be sure to leave a service loop on the float switch wiring to allow removal of the tank access cover.

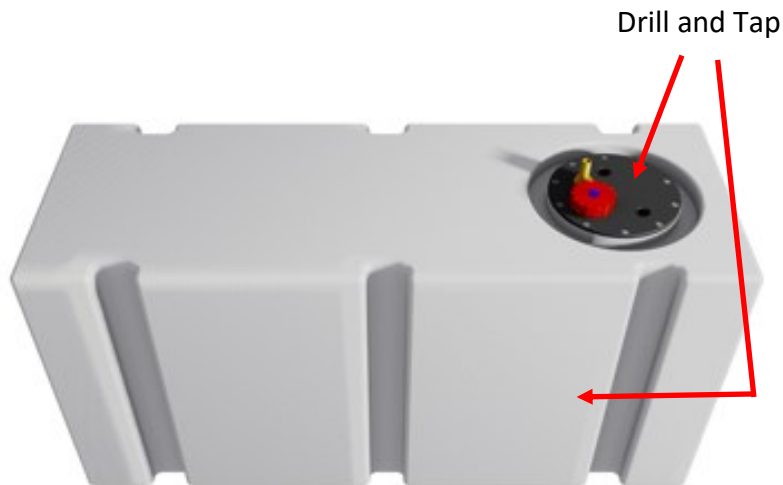

New System Start-Up and Testing

Avoid running the Catalina system if the vessel is in contaminated water. The system should be fully tested before leaving port. If the location or weather prevents proper testing, refer to **Dry Testing with an Artificial Ocean** on page 28.

Every new system is shipped from the factory with nontoxic, food-grade propylene glycol. Propylene glycol, Spectra Chemicals, or anything other than seawater or freshwater must be purged from the system with the pressure relief valve open at least 1/2 turn. You can purge your system with seawater or with freshwater via the system's freshwater flush function. The system must be purged for a minimum of 60 minutes, or until at least 40 gallons of water have moved through the system.

*****When purging SC-1 from a pickled watermaker, system must be purged for a minimum of 20 minutes. Propylene Glycol should be purged for minimum 60 minutes*****

Warning! Damage may occur if the purge sequence is bypassed and the membrane is pressurized with storage chemical in it.

1. First, check that:

- Thru-hull inlet and the brine discharge valves are open.
- All of your hose connections are tight.
- The washer with the green tag under the pressure relief valve has been removed.
- The pressure relief valve is open at least 1/2 turn.
- The sampling valve is set to the sample position
- The brine line is able to freely discharge

Remove Tag and Washer!

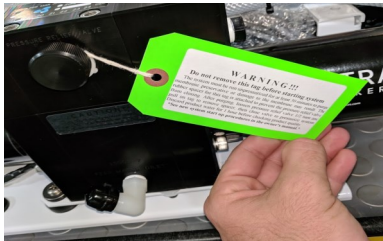

Open 1/2 Turn when purging chemicals!



3-Way Sampling Valve

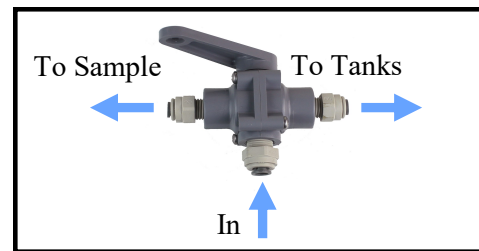

For a purge with seawater

- Move to an area free of contaminated water. Avoid areas such as polluted harbors or canals.

For a purge using the freshwater flush

- The vessel's pressurized water system is on

2. Turn on feed pump via the **manual toggle switch** and check to make sure water is coming out of the brine discharge (thru-hull above water).

3. Run the system without pressure for 60 minutes to purge the storage chemicals. The pressure gauge should read less than 35 PSI. If purging with freshwater, the sampling tube may discharge water.

4. Close the pressure relief valve. The pressure should rise to 60-80 PSI (4.2-5.7bar) on a Catalina 340R. Water should begin to flow out of the sampling tube. If the ship is located in brackish or fresh water, the pressure will be lower.

Depending on storage and environmental conditions the system may need to have additional purging time. If the product water does not taste pure or sample at below 500 ppm, purge or run the system with the pressure relief valve open for up to 6 additional hours.



Dry Testing with an Artificial Ocean

If it is not possible to test run the system with the boat in the water, you may test the system with an artificial ocean. You will need 1.3 lbs. of non-iodized salt (rock salt, sea salt, or aquarium salt) to make a 5 gallons (33 grams of salt per liter) of water that is about 33,000 PPM salinity (average seawater salinity). Make sure the domestic water system is powered up and the boat's tank has at least 60 gallons (230 Liters) of water to purge the storage chemicals from the system. Confirm that the charcoal filter is installed in the feed pump module, and the domestic water line is connected.

1. **Open the pressure relief valve on the Clark Pump. Remove the green tag and spacer.**
2. Press the **Fresh Water Flush (FWF)** button to run a full flush cycle. Do this **six** times to purge the storage chemicals, a 36 minute process.
3. Replace the brine overboard hose with the brine service hose per Figure 3.
4. Push the **Fresh Water Flush (FWF)** button again to fill the bucket with fresh water from the brine discharge service hose (hose attached to Clark Pump). Press **Stop** when the bucket is full.
5. Mix the salt to the proper proportion or use an aquarium hydrometer to adjust the salinity level to a specific gravity of 1.025.
6. Disconnect the quick release fitting from the pigtail coming from the charcoal filter housing outlet and connect the intake service hose per Figures 4. Route both service hoses into a 5 gallon (20 liter) bucket. Disconnect the product tube from the diversion valve manifold, and using another small piece of tube, route it into the bucket.
7. Push the **Start** button, allow the system to prime, and then close the pressure relief valve. The system should build pressure shortly and start making water, with the brine and product water recombining in the bucket to be cycled again. This will gradually heat the water. Do not let the water temperature exceed 120 deg. F (49 deg. C). Run the system for roughly 45 minutes of operation.
8. While the system is running pressurized, check for proper operation and leaks. After testing the system, re-install the brine discharge hose, product tube, and fresh water hose from the strainer. You can now flush the system by pressing the **Fresh Water Flush** button.

Remove tag
and washer

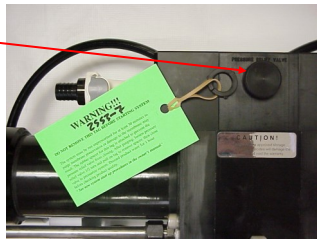

Fig. 1

OPEN PRESSURE
RELIEF VALVE

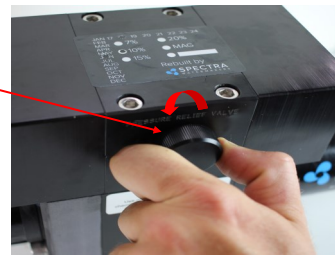

Fig. 2



Fig. 3



Fig. 4

Spectra Manual Remote Controller Guide

If the system has been pickled, winterized, this is the first startup, or the condition of the system is unknown, go to NEW SYSTEM START-UP on page 27 or serious damage may occur.

A fresh water flush should be performed after every use of the watermaker. The system will need to run for approximately half an hour to make enough fresh water for one flush.



Start

Pressing the 'Start' button begins watermaker operation.



Stop

Pressing the "Stop" button ends watermaker operation. The "Stop" button must be pressed before beginning a Fresh Water Flush.



Fresh Water Flush (FWF)

Pressing the 'Fresh Water Flush' (FWF) button floods the watermaker with fresh water from the vessel's domestic water tanks. Opens solenoid valve to allow water to flow from tank instead of seawater from the thru-hull. Fresh Water Flush mode will end automatically after flush is complete, approximately 3 minutes.



Fault Light

The "Fault" light indicates that there is a problem with the system. This relates to a high pressure or boost pressure fault, read by the vacuum switches attached to vane pump.

Freshwater Flush Calibration

Flush Adjustments

Adjustments for your Catalina 340R are typically calibrated from the factory to ensure that sea water is thoroughly flushed out of the watermaker using the least amount of fresh water.

However, due to different lengths of hose runs, different rates of flow, and different pressures in shipboard fresh water systems, the flush duration should be optimized for your boat. The flush cycle is adjusted with 2 settings: the pump speed and the flush duration.

Check the pump speed

1. Close the thru-hull for the raw water inlet.
2. Push the **Fresh Water Flush (FWF)** button. The flush valve will open and the feed pump will start at Flush Speed. If the flush completes normally, then the Flush Cycle is set properly.

Slowing down the pump during a Fresh Water Flush

Inside the feed pump module, next to the Control Box, is the pump speed controller. On the speed controller board are two magnetic reed switches for adjusting the pump motor speed. The switches are narrow black bars, 5/8" (16mm) long. The increase speed switch is labeled S2; the decrease speed switch is labeled S3. Each time a small magnet is placed near the switch with the pump is running, the speed will change slightly.

1. Open the thru-hull for the raw water inlet.
2. Push the **Fresh Water Flush (FWF)** button.
3. Gently tap a magnet on the S3 Reed Switch (Decrease Speed Switch). Wait 3 seconds between each pass of the magnet.
4. Gently tap the magnet 3 times, then go back to step 3.

Once you've adjusted the speed correctly, the speed controller will stay programmed for this speed during fresh water flushes.

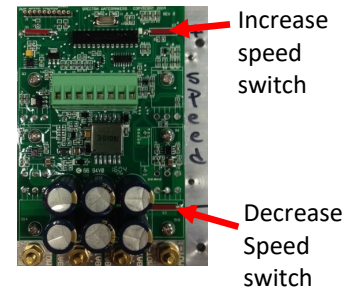

Adjusting Fresh Water Flush Duration

3. Check/Adjust the flush duration

Run the watermaker for 10 minutes to fill the system with seawater, confirm that good product water is being sent to the tanks.

Press the 'Stop' button. The system will stop. Press the 'FWF' button and the system will begin flushing.

Allow the fresh water flush to continue to completion. At the end of the flush cycle capture some of the flush water at the brine discharge in a clean cup. Measure the salinity of the brine discharge and confirm that it is below 1000ppm using a calibrated hand held TDS meter.

If the flush duration needs to be increased, continue reading.

The Catalina Freshwater Flush Duration is set to a factory default of **3 minutes**, which is usually the right amount of time to ensure that seawater is thoroughly flushed out of the watermaker using the least amount of fresh water. However, due to different lengths of hose runs, different rates of flow, and different pressures in shipboard fresh water systems, the flush duration can be optimized for your boat.

Set the Flush Duration with a small screwdriver so that the fresh water flush comes to an end just as the salinity of the brine discharge drops below 1000 PPM, or no longer tastes brackish. Since the flush duration can only be adjusted in round minutes, you may want to lessen the duration to 2 minutes, to save water, or increase to 4 or more minutes to ensure a thorough flush.

Also, the charcoal filter is rated for 1.5 GPM (6 LPM): If the system pushes more than 1.5 GPM through the charcoal filter

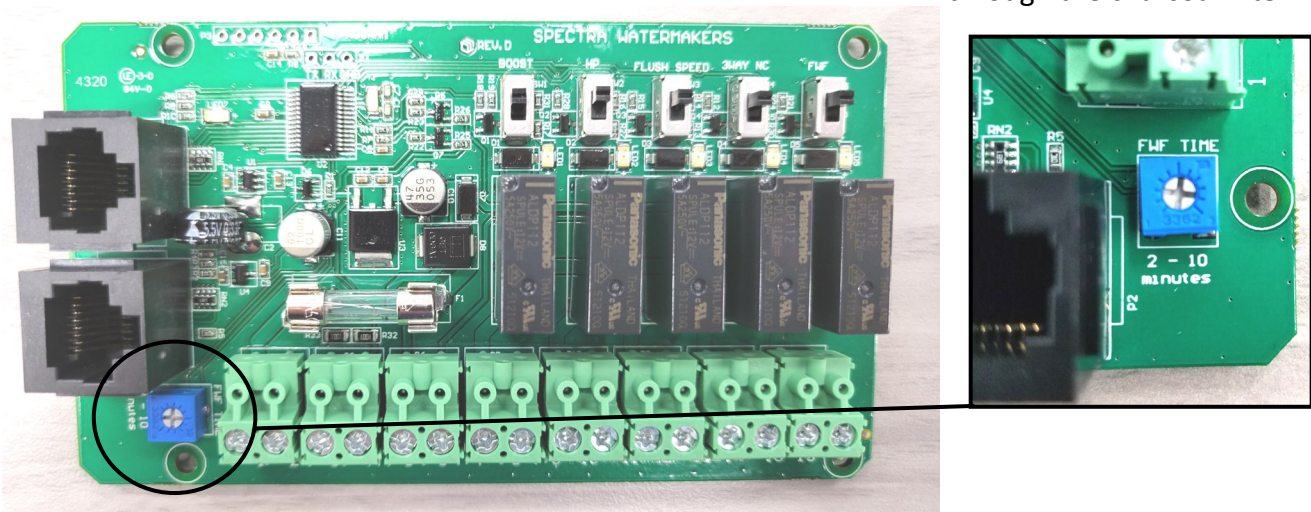

Normal Operation and Fresh Water Flush

If the system has been pickled, stored, or contains cleaning compounds, use the New System Startup procedure. The system should be fully run tested before you leave port. If the location or weather prevents proper testing refer to "Testing with an Artificial Ocean."

1. Check that the thru-hull inlet is open.
2. Turn the product sample valve to the **SAMPLE** position.
3. Turn the toggle switch on the feed pump module to **RUN MANUAL**.
4. Start the system by pushing 'Start' and check for flow by inspecting the brine discharge and checking for pressure on your analogue gauge. If there is no flow, open the pressure relief valve on the Clark Pump to prime the system and bleed the air out of the feed pump.
5. After 5 minutes, check the product water with your handheld salinity tester. When it is below 750 PPM, divert the product into your tank by rotating the product sample valve handle 90 degrees.
6. Run the system until you have filled your tank or have made enough to meet your requirements.
7. Following your water making session, perform a freshwater flush.

Freshwater Flush (You should freshwater flush your watermaker after EVERY use.)

1. Push the **Freshwater Flush** button on the remote panel.
2. The freshwater flush solenoid will open and feed pump will come on, allowing pressurized freshwater to flow through the system. Pressure will drop on the gauge, which indicates that the membrane is flooded with fresh water.
3. After a proper flush, the ppm of the brine discharge should be below 1000ppm.

You may now leave the system unattended for up to five days (30 with the Z-Ion) without further attention.

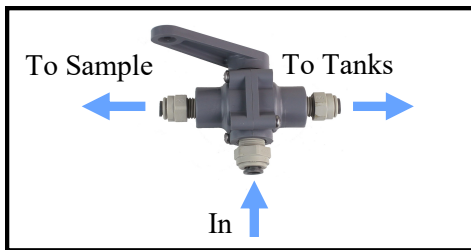

3-Way Product Sampling Valve



Analog Gauge Panel



Remote Panel

Nominal Operating Parameters

System	AMPS				Feed Pressure		Static *	Total Flow/Feed Flow				Product Flow				Product Quality
	12V	MAX	24V	MAX	PSI	bar	PSI	GPM	LPM	GPM (min)	LPM (min)	GPH	LPH	GPH (min)	LPH (min)	TDS
Catalina 340	19.5	21.5	9.75	10.75	90-100	6.3-7	25-35	2.8	10.6	2.7	10.2	14	52.9	13.5	51.0	< 300

For Spec Production:

12V Systems: Run at 13.2 VDC min
24V Systems run at 26.4 VDC min

Maintenance



General

Periodically inspect the entire system for leakage and chafing. Repair any leaks as soon as you find them. Some crystal formation around the Clark Pump blocks is normal. Wipe down any salt encrusted areas with a damp cloth.

Watermakers are at their best when run regularly. Biological fouling in the membrane is more likely when a watermaker sits idle. A warm environment will cause more growth than a cold environment. A fresh water flush every five days will greatly reduce biological growth, but may not stop it completely. The Z-Ion system protects the membrane from bio-fouling without the use of storage chemicals and can be flushed every 30 days for maximum effectivity.

The Seawater Strainer

The seawater strainer's stainless steel element should be inspected, removed, and cleaned as needed. Ensure that the thru-hull is closed before disassembly and the gasket is in place before reassembly. When the system is put into storage, remove the strainer, rinse with fresh water, and reassemble dry to impede corrosion. Check frequently during operation.

Prefilter Assembly

Prefilter elements must be changed frequently. The rate is solely dependent on the input water. A 5-micron filter might last you a 4-6 weeks in clear open ocean seawater, or be ruined in minutes in a dirty harbor. A vessel may be sailing through seemingly super clear water, but cruise through a plankton bloom and the prefilter will be ruined. Spectra does not advise to attempt to clean dirty prefilters. Prefilters are a consumable item and should be changed for new when in question. **Please review prefilter bulletin to page 49. prior to running your system.**

To service the filter close the thru-hull, open the prefilter housing, remove the old filter, clean out the housing bowl, and reassemble the housing with a new 5 micron filter element. Leave dry until next startup.

Note: Use only Spectra-approved filters or you may void your warranty. Occasionally, lightly lubricate the O-rings with silicone grease.

Oil/Water Separator (Optional)

To install oil water separator capability, add a second filter housing UPSTREAM of the 20 and 5 micron housings. Service as you would per the instructions above.

Maintenance - Cont.

The Charcoal Fresh Water Flush Filter

Replace the charcoal filter element **at least every 6 months**. This filter protects the membrane by removing chlorine from the flush water. Use only a Spectra-approved replacement.

The Feed Pump and Clark Pump

The feed pump and the Clark Pump require no routine maintenance except inspection for leaks. Tighten any hose clamps or fittings that show signs of leakage. The high pressure fittings threaded into the Clark Pump have O-ring seals with a straight thread. These should never leak and should never be over-tightened. If one of the tube nuts starts to leak, it can be un-threaded, sealed with a bit of silicone grease or oil, and tightened with two wrenches very tightly.

The Membrane

Membranes are susceptible to mineral scaling, biofouling and oxidation damage. The leading cause of fouling is biological growth that forms when the system is left unused without flushing or pickling. Fouling from mineral scaling can happen under certain seawater conditions, or from rust. Oxidation damage can occur if the membrane comes into contact with any strong oxidant, such as Ozone, Chlorine, etc. Monitor the product salinity and feed pressure for higher than normal readings, take environmental conditions into consideration.

Note:

- Cold feed water or a higher salinity seawater source can cause high pressure.
- Low product flow is usually due to low voltage, a worn feed pump, or worn Clark Pump.

Due to the unique design of your Spectra system, low product water volume is typically not a membrane problem, but frequently related to low voltage, a worn feed pump head, or a worn Clark Pump. Always perform a flow test before cleaning your membrane.

Test to see if biological growth has occurred: Before running the system, remove the prefilters and examine their condition. If the filter housings are full of smelly, discolored water, the system was not properly stored. Install clean prefilters.

Next check the membrane. Detach the brine discharge hose, attach the brine service hose, and lead it to a bucket. Open the pressure relief valve 1/2 turn, and manually run the system for 30 seconds (metal toggle switch on feed pump module). Examine the brine water: If it is discolored and smells bad, perform an SC-2 cleaning with unchlorinated water before running the system pressurized. If the brine is fairly clean, follow the New System Startup procedure on page 27 and run normally. Check for performance. Clean the membranes **only if** performance is reduced.

See the **Cleaning Procedure** for complete instructions.

Maintenance - Cont.

Leaking Fittings

The system has eight high pressure fittings, two on each cylinder on the Clark Pump, two on the pressure vessel end caps, and two 90-degree elbows on the back of the Clark Pump. As the compression fitting is tightened, it compresses a ferrule onto the stainless tubing, fixing the ferrule permanently to the tube and holding the compression nut captive.

The body of the fitting seals to the underlying component with an O-ring. On the Clark Pump cylinders and the end caps this O-ring is compressed by tightening the entire fitting. The O-rings on the 90-degree fittings on the back of the Clark Pump have captive nuts and washers, which compress the O-rings without turning the entire fitting.

If a tube fitting leaks it can sometimes be resealed by just tightening. You must use two wrenches, a 13/16-inch wrench to hold the base, and a 7/8-inch wrench to turn the compression nut. The 13/16-inch wrench will need to be thin so as not to interfere with the compression nut. If this doesn't work, disassemble the fitting, grease liberally with silicone grease (the ferrule and the threads) and re-tighten firmly.

The base O-rings should be **gently** compressed to achieve a good seal, and may be damaged by overtightening.

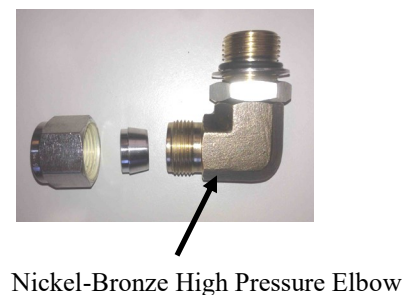
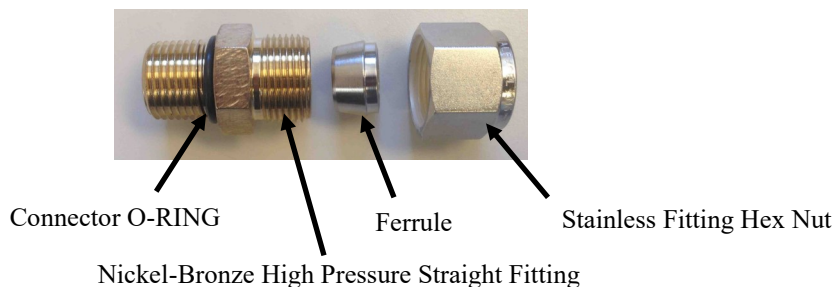

Maintenance - Cont.

Introduction to Spectra Chemicals

We use four types of chemicals: SC-1, SC-2, SC-3, and propylene glycol antifreeze. SC-1 and propylene glycol are for system storage, while SC-2 and SC-3 are for membrane cleaning. **Do not use sodium-bisulfate, citric acid, or any other storage chemical not supplied by Spectra.** These chemicals, used to store other watermaker brands, will damage the Clark Pump, membrane end plugs, manifolds, and other components. **Using non-Spectra chemicals will void the warranty.**

Note: Never use any chemicals with the system pressurized! Always open the pressure relief valve 1/2 turn. Always follow the instructions for purging the chemicals as shown in the New System Startup section.

Storage

SC-1 prevents biological growth when your system is idle. It should not be used as a cleaning chemical, nor will it protect your system from freezing. A bag of SC-1 is mixed with 1 to 2 gallons of product or dechlorinated fresh water in a bucket and circulated through the system for 10 minutes. This treatment will protect the system for six months, after which the SC-1 treatment must be repeated. To use SC-1, follow the instructions for **Storage Procedure**.

Spectra systems should be stored with propylene glycol if freezing is likely to occur. Propylene glycol can be used instead of Spectra SC-1 storage chemical for storage in any climate, and treatment is effective for one year. Propylene glycol is a food-grade antifreeze used to winterize RV's, boats, and cabins. Do not use ethylene glycol automotive antifreeze, which is toxic and will damage the system.

The propylene glycol formulations sold in marine and RV stores are usually diluted with water. The water remaining in the watermaker before the storage procedure will further dilute the antifreeze, reducing the microbial protection and increasing the temperature at which the mixture will freeze.

Antifreeze labeled "Minus Fifty" is a 25% solution and will begin to form an icy slush at about +15Degrees F (-10C) and will only provide burst protection to about Zero F (-18C). After a further 50% percent dilution by water remaining in the watermaker, "Minus Fifty" antifreeze will only protect from bursting down to about +25F (-4C). Therefore if low temperature freezing protection is required a 60% or stronger antifreeze should be used. 60% solutions are labeled "Minus 100" and will provide burst protection to -15F (-27C) even after a fifty percent dilution with residual water. "Minus 200" formulations are pure propylene glycol.

Maintenance - Cont.

Introduction to Spectra Chemicals - Cont.

Complete microbial protection requires a 25% solution of propylene glycol, so care must be taken that the solution remaining in the watermaker during long term storage is at least 25%, even if freeze protection is not required. For these reasons Spectra recommends that all pickling be carried out with a 60% or greater concentration.

See **Winterizing with Propylene Glycol**.

Propylene glycol can be difficult to flush from a membrane, especially after extended storage periods. This results in high salinity water (high PPM) and residual flavor in the product water. We recommend flushing the system WITH THE PRESSURE RELIEF VALVE OPEN for 4-6 hours after storage with propylene glycol—the longer the better. If, after extended flushing, you still experience low product water quality, cleaning with SC-2 usually removes all traces of propylene glycol and returns the salinity to the level it was before storage with propylene glycol. See the **Membrane Cleaning Procedure**.

Cleaners

Avoid unnecessary cleaning, and avoid cleaning as a diagnostic tool.

SC-2 is an alkaline cleaner used to remove light oil, grime and biological growth. It is most effective if heated to 120 deg. F (49 deg. C). In most cases the water quality will increase in PPM (salinity) after an SC-2 cleaning. After a few hours it should recover to near the level it produced before the cleaning.

SC-3 is an acid cleaner used to remove mineral and scale deposits. In most cases this is used first and if there is no improvement, go on to the SC-2 cleaning. SC-3 will in most cases lower the product PPM and overall pressures. Scaling is a slow process that may take several months or years.

For cleaning with either SC-2 or SC-3, see **Membrane Cleaning Procedure**.

Storage Procedure

1. Close the intake seacock.
2. Push the **Fresh Water Flush (FWF)** button to fresh water flush the system. Perform a second fresh water flush in the same way.
3. Remove the quick disconnect fitting from the brine discharge outlet of the Clark Pump, per photo below, and replace it with the quick disconnect brine discharge service hose. Lead the brine service hose into the bucket.
4. Push the **FWF** button and run the feed pump until you have one gallon of fresh water in the bucket from the brine discharge service hose, then press **Stop**.
5. Mix 1 container of SC-1 storage compound with the water in the bucket. It may not dissolve completely, which is normal, and any undissolved particles will be caught by the prefilter.
6. Remove the hose from the “to strainer” pigtail on the feed pump module and install the inlet service hose from the service kit, per photos below. Lead this hose into the 5 gallon (20 liter) bucket as well.
7. **Make sure the pressure relief valve on the Clark Pump is OPEN (un-pressurized) by turning 1/2 turn counterclockwise**
8. Turn on the feed pump by moving the manual control switch on the control box to ‘SERVICE’. The solution will be drawn from the bucket with the service hose, and returned to the bucket from the brine discharge service hose. Circulate the storage chemical in the system for approximately 20 minutes. Stop the feed pump by moving the switch back to the ‘RUN AUTO’ position.

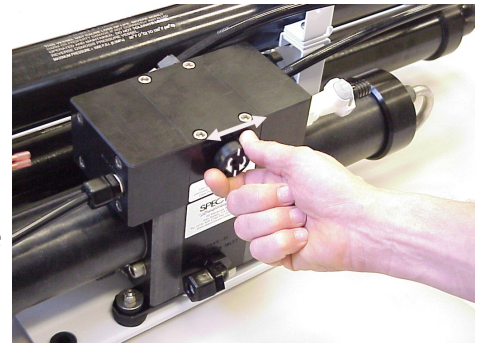

Clean Up

Remove the brine discharge service hose from the Clark Pump, and replace the brine discharge hose that leads to the thru-hull. You may now pump the bucket dry by moving the manual control switch on the Control Box back to ‘SERVICE’. Stop the feed pump by moving the switch back to RUN AUTO.

Remove the inlet service hose and reattach the hose from the sea strainer to the “To Strainer” pigtail on the manifold at the Feed Pump Module. Drain and clean the strainer and any filters in the system. Reassemble dry. Leave the pressure relief valve open, since the next time you run the system you will need to purge the storage chemicals with the system unpressurized. Turn off the power to the system.



Connecting brine discharge service hose



Removing hose to sea strainer from the “to strainer” pigtail.



Attaching intake service hose to the hose connecting to the sea strainer.

Winterizing With Propylene Glycol

See description of propylene glycol formulations, and purging from system.

1. Close the intake seacock.
2. Push the **Fresh Water Flush (FWF)** button to fresh water flush the system. Perform a second fresh water flush in the same way.
3. Remove the hose from the “To Strainer” pigtail, install the inlet service hose from the service kit, and lead the hose to the bottom of a bucket. Connect the brine service hose, and run it into a second container.
4. Pour 1 gallon (4 liters) of propylene glycol of appropriate concentration into the bucket with the intake service hose.
5. **Make sure the pressure relief valve on the Clark Pump is OPEN 1/2 turn (un-pressurized).**
6. Run the feed pump by switching the manual switch on the control box to ‘SERVICE’ until about a gallon of water has flowed from the brine discharge service hose, or antifreeze appears. Propylene glycol will look slightly different, and feel more slippery, than water. Stop the pump by moving the switch back to ‘RUN AUTO’. Add more propylene glycol to the intake bucket if necessary.
7. Lead the brine discharge service hose into the intake bucket of propylene glycol. Move the switch back to ‘SERVICE’. The service hose will now draw propylene glycol solution from the bucket, and the brine discharge service hose will return it. Run the feed pump and circulate the propylene glycol for 20 minutes.
8. Stop the feed pump by switching the toggle switch back to ‘RUN AUTO’. Drain the seawater strainer, the hose leading to the boost pump module, and the hose between the boost pump module and the feed pump module. Disconnect the product tubing from the membrane housing and blow residual water out of the tubing. Empty the charcoal filter housing and flush water lines. Leave the pressure relief valve open, since the next time you run the system you will need to purge the system unpressurized.

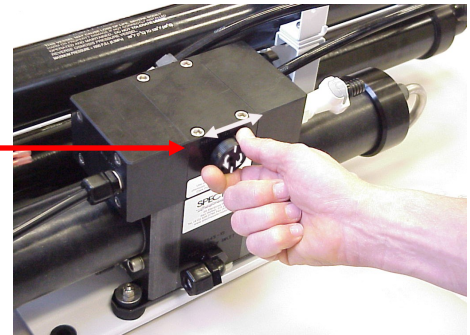

*Your watermaker is now protected from freezing and biological growth and freezing for **one year**.*



Removing hose to sea strainer from the “to strainer” pigtail.



Attaching intake service hose to hose to sea strainer.



Connecting brine discharge service hose

Membrane Cleaning Procedure

Spectra cleaning compound (SC-2 or SC-3) must be mixed with fresh water at a ratio of 1 container of compound to 3 gallons (12L) of unchlorinated water. A Catalina 340R system requires one container of compound per cleaning.

1. Close the intake seacock.
2. Push the **Fresh Water Flush (FWF)** button to fresh water flush the system. Perform a second fresh water flush in the same way.
3. Remove the quick disconnect fitting from the brine discharge outlet of the Clark Pump, and replace it with the quick disconnect brine discharge service hose. Lead it into a 5 gallon (20 liter) bucket. Push the **Fresh Water Flush (FWF)** button and run the feed pump until one gallon of fresh water runs into the bucket from the brine discharge service hose. Press **Stop**.
4. Remove the hose from the "To Strainer" pigtail and install the inlet service hose from the service kit. Lead both hoses into the bucket.
5. **Make sure that the pressure relief valve on the Clark Pump is open (un-pressurized).**
6. Mix the cleaning chemical in the bucket. If possible, heat the solution to 120 F (49 C).
7. Move manual switch on the Feed Pump Module to SERVICE SYSTEM. The intake service hose will draw solution from the bucket and the brine discharge service hose will return it. Circulate the solution through the system in this manner for 45 minutes. Stop the pump by moving the toggle switch back to 'RUN AUTO'.
8. If the solution cannot be heated, allow the solution to sit overnight before proceeding to the next step.
9. Replace the brine discharge overboard hose and run the pump until the bucket is empty by moving the manual switch to 'SERVICE'. Return the switch to 'RUN AUTO'.
10. Follow the New System Startup procedures to flush the chemicals out of the system (**DO NOT CLOSE the pressure relief valve!**)
11. The system may now be restarted, flushed, or stored.

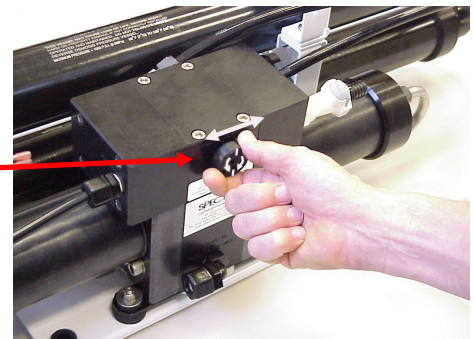

Connecting brine discharge service hose



Removing hose to sea strainer from the "to strainer" pigtail.



Attaching intake service hose to the hose connecting to the sea strainer.

Suggested Spares for the Catalina 340R

Short term cruising, weekends etc.

We suggest two treatments worth of preservative chemicals (either 2 bags of SC-1 or 2 gallons of Propylene Glycol). Six 5-micron filters and one Carbon filter.

Cruising 2 to 6 months at a time.

Twelve 5-micron filters, 2 Carbon filters, enough preservative chemicals for 4 treatments, one replacement feed pump head.

Longer than 6 months

Additional filters, offshore cruising kit consisting of Clark Pump seals, O-rings, tools and membrane cleaning chemicals. One replacement strainer screen, replacement O-ring for strainer screen, and replacement O-rings for the filter housings.

Common Parts:

Item	Part Number
SC-1 STORAGE CHEMICAL	KIT-CHEM-SC1
SC-2 CLEANER	KIT-CHEM-SC2
SC-3 CLEANER	KIT-CHEM-SC3
BASIC CRUISE KIT A	KIT-BCK-A
OFFSHORE REBUILD KIT	KIT-OFFSH
5 MICRON FILTER	FT-FTC-5
CHARCOAL FILTER	FT-FTC-CC
6" STRAINER SCREEN	FT-STN-6S
OIL/WATER FILTER	FT-FTC-OW
FEED PUMP HEAD	PL-PMP-140MAG
6" STRAINER O-RING	SO-STN-6SS
CHARCOAL FILTER HOUSING O-RING (x2)	SO-FHS-3PCS10
1/2" TUBE STEM X 1/2" NPT ADAPTER (x2)	PL-STA-12TX12NJ

All sales are made through Spectra's network of dealers/full service providers. Contact your local full service provider for additional suggestions and support.

Troubleshooting Catalina Remote Manual Systems

SYMPTOMS	PROBABLE CAUSE	REMEDY
No product flow, good brine discharge flow, Recovery percentage is 0 (See Flow Test)	<ul style="list-style-type: none"> Internal leak in Clark Pump 	<ul style="list-style-type: none"> While system is running, kink brine hose to stop flow until pressure rises to 125psi (a few seconds), release hose quickly, repeat no more than 10 times in succession. *NOTE: RELEASE HOSE AS SOON AS VANE PUMP BEGINS TO LABOR OR PERMANENT DAMAGE MAY OCCUR Inspect Clark Pump Check Valves Complete Service is recommended. Contact Dealer or see Clark Pump rebuild manual. Install Offshore Kit
Feed pump runs with loud noise	<ul style="list-style-type: none"> Intake blocked Air in system 	<ul style="list-style-type: none"> Check thru-hull valve Check sea strainer for leaks Check fresh water flush module for leaks Re-prime system (restart)
Feed Pump not running, no noise	<ul style="list-style-type: none"> No power at feed pump DC speed controller needs to be adjusted DC speed controller malfunction 	<ul style="list-style-type: none"> Check voltage at motor/speed controller MTR leads Adjust speed controller per manual directions Replace speed controller
Feed pump turns on, no pressure	<ul style="list-style-type: none"> Feed pump air locked Pressure relief valve open 	<ul style="list-style-type: none"> Open pressure relief valve to bleed the air, then close to start Close pressure relief valve
Display activates, but pump will not run	<ul style="list-style-type: none"> Loose or broken pump wire connection Tanks are full (if equipped with tank switch). If full, Run & Stop LED should be lit. 	<ul style="list-style-type: none"> Check wiring at terminal block inside control box Check tanks– system cannot be started if tanks are full.
System runs, no product water delivered to water tanks	<ul style="list-style-type: none"> Disconnected or broken product tubing 3-Way Valve Incorrectly set 	<ul style="list-style-type: none"> Check product tubing Check 3-Way Valve position Check pressure relief valve is tightly closed.
Low Feed Pressure, Low Amperage	<ul style="list-style-type: none"> Warm saltwater or brackish water 	<ul style="list-style-type: none"> Normal condition
High feed pressure, High Amperage, & Product Flow down up to 15%	<ul style="list-style-type: none"> Colder or more saline water Brine or product flow path subject to back pressure Scaled or fouled membrane 	<ul style="list-style-type: none"> Normal condition Confirm by routing into a bucket to test Clean Membrane

Troubleshooting Catalina Remote Manual Systems

SYMPTOMS	PROBABLE CAUSE	REMEDY
Low product flow, more than 1 GPH Total flow down (see flow test)	<ul style="list-style-type: none"> • Motor receiving less than 12.5 VDC • Blockage or restriction in system • Thru-hull blockage • Mineral Scaling • Pump or Motor worn 	<ul style="list-style-type: none"> • Check wiring for voltage drop. Increase wire size if necessary • Check voltage at speed controller • If available, turn on battery chargers • Replace prefilter, service strainer, check all hose runs • Confirm by using intake service hose and bucket of seawater to bypass. • Clean Thru-hull • Perform SC-3 Cleaning (<i>Note: By design, it is rare for a membrane to cause low total flow on Spectra systems</i>) • Pump should be able to push 2.7 G/M @ 90-100psi • Replace pump head
Low product flow. Recovery percentage below minimum nominal value (See Flow Test)	<ul style="list-style-type: none"> • Pressure relief Valve open partially • Internal leak in Clark Pump 	<ul style="list-style-type: none"> • Close Pressure relief valve • Complete service recommended. Contact dealer of see Clark Pump rebuild manual. • Install offshore kit
Asymmetrical pressure and flow readings between pump shifts, more than a few psi	<ul style="list-style-type: none"> • Scored Clark Pump annular rings and/or reversing valve spool • Scored Clark Pump piston rod and/or lip seals • Scored Clark Pump cylinders 	<ul style="list-style-type: none"> • Replace • Confirm by opening test port on back of Clark Pump. If constant flow, replace seals and circular sand rod (240 grit) or replace piston rod • Hone, circular sand (240 grit) or replace

Catalina 340R Fault Alarms

SYMPTOMS	PROBABLE CAUSE	REMEDY
Fault Light Illuminated	<p data-bbox="516 317 867 344"><u>High Pressure or Vacuum Switch</u></p> <ul data-bbox="516 384 867 995" style="list-style-type: none"> <li data-bbox="516 384 867 474">• Blocked brine discharge <li data-bbox="516 422 867 474">• Restriction in Clark Pump/ Membrane <li data-bbox="516 646 867 699">• Product line not vented, causing back pressure <li data-bbox="516 871 867 898">• Fouled membrane <li data-bbox="516 968 867 995">• Vacuum switch faulty 	<ul data-bbox="964 380 1328 1024" style="list-style-type: none"> <li data-bbox="964 380 1328 407">• Check brine discharge <li data-bbox="964 415 1328 600">• Check static pressure (pressure with system running and pressure relief valve open 1/2 turn) *Nominal Static Pressure on CT340 is 25-35psi <li data-bbox="964 642 1328 758">• Route product vented to atmosphere. Preferred method is freefall into top of tank. <li data-bbox="964 772 1328 863">• Diagnose by routing product water into bucket and run system <li data-bbox="964 898 1328 926">• Clean membrane <li data-bbox="964 999 1328 1024">• Replace vacuum switch
	<p data-bbox="532 1161 867 1188"><u>Boost Pressure Vacuum Switch</u></p>	
	<ul data-bbox="532 1262 899 1381" style="list-style-type: none"> <li data-bbox="532 1262 899 1289">• Prefilter/Sea Strainer clogged <li data-bbox="532 1360 899 1381">• Intake restriction 	<ul data-bbox="971 1262 1341 1507" style="list-style-type: none"> <li data-bbox="971 1262 1341 1289">• Install new prefilters <li data-bbox="971 1297 1341 1325">• Clear strainer <li data-bbox="971 1360 1341 1507">• Clear obstruction *Check black 2-piece hexagon check valve attached to boost pump/ sea strainer module
	<ul data-bbox="532 1717 915 1837" style="list-style-type: none"> <li data-bbox="532 1717 915 1770">• Boost Pump not receiving 24V, or disconnected <li data-bbox="532 1812 915 1837">• Vacuum switch faulty 	<ul data-bbox="971 1717 1341 1837" style="list-style-type: none"> <li data-bbox="971 1717 1341 1770">• Check voltage at boost pump, check wiring. <li data-bbox="971 1812 1341 1837">• Replace vacuum switch



Catalina 340R Flow Test

The flow test is the most useful diagnostic test for system performance, and should be done before replacing or cleaning your membrane. Changes in production or water quality are normally caused by something **other than** the membrane, unless the system has been left unused for a long time.

Before the flow test, change all filters and clean the sea strainer. Carefully check for water or air leaks, as air in the system will cause low production and erratic salinity. Look for air bubbles in the product flow meter, feed water hoses, and brine overboard hose.

Run the system and watch the feed pressure very closely. If the feed pressure to the Clark Pump is asymmetrical from one stroke to another, this impedes performance. **A difference of a few PSI is acceptable, but anything over that is an issue.** If the pump is asymmetrical, Clark Pump repairs should be done before continuing with these tests.

If no asymmetry is noted, continue with this test.

You will need a graduated bucket, either a graduated pitcher or large measuring cup, and a stopwatch. Log the voltage at the feed pump at the same time. Confirm **at least 12.5 Volts at the feed pump on 12-Volt DC systems.**

Take two measurements and compare them with the table on the following page. The first measurement is the **product flow** alone. The second is the **product flow combined with the brine discharge flow to get the total flow** or feed flow. You may take these measurements by two methods:

1. Time the product flow into a graduated pitcher, then divert both the product flow and brine discharge together into a bucket, timing them to measure total flow.

OR

2. Divert the product flow into the pitcher while diverting the brine discharge into the bucket. Time the flow of both at the same time. After calculating the product flow, pour the pitcher of product into the bucket of brine to measure total flow.

The ratio of product flow to total flow gives us our recovery rate, as a percentage. If the percentage is below the minimum it indicates an internal leak in the Clark Pump.

1. Product Flow: Product flow is expressed in Gallons Per Hour (GPH) or Liters Per Hour (LPH), by this equation:

$3600 \div \text{time in seconds} \times \text{quantity of water in gallons or liters} = \text{GPH or LPH}$
 There are 3600 seconds in an hour.

Example: It took 3 minutes and 35 seconds to collect 1 gallon of product water.

$3600 \div 215 \times 1 = \mathbf{16.74 \text{ GPH}}$ (3 minutes, 35 seconds is 215 seconds)

Example: It took 2 minutes and 25 seconds to collect 2.5 liters of product water.

$3600 \div 145 \times 2.5 = \mathbf{62.07 \text{ LPH}}$ (2 minutes, 25 seconds is 145 seconds)

2. Total Flow or Feed Flow: Feed flow or total flow (brine + product) is expressed in Gallons Per Minute (GPM) or Liters Per Minute (LPM), by this equation:

$60 \div \text{time in seconds} \times \text{quantity of water in gallons or liters} = \text{GPM or LPM}$

Example: It took 1 minute and thirty-seven seconds to collect 5 gallons of total flow.

$60 \div 97 \times 5 = \mathbf{3.09 \text{ GPM}}$ (1 minute, 37 seconds is 97 seconds)

Example: It took 53 seconds to collect 12 liters of total flow.

$60 \div 53 \times 12 = \mathbf{13.58 \text{ LPM}}$

3. Recovery Rate: $\text{Product Flow} \div \text{Total Flow} = \text{Recovery Rate \%}$

Example: $\frac{6.5 \text{ GPH product flow}}{1.7 \text{ GPM total flow} \times 60} = \mathbf{.063 \text{ or } 6.3\%}$

(you must first multiply total flow by 60 to convert from GPM to GPH)

***pressure relief valve open ½ turn**

In order to make good quality product water, you need the proper amount of feed water flow, as in the table below. Compare the product flow to the total feed flow. Product flow should be 9.0% of total flow for a Catalina 340R. If product percentage is low, you may have an internal leak in the Clark Pump.

For every $\frac{1}{10}$ th of a GPM feed water flow loss, we will lose about $\frac{1}{2}$ gallon per hour of product flow and the salinity will go up 100 PPM.

System	AMPS				Feed Pressure		Static *	Total Flow/Feed Flow				Product Flow				Product Quality
	12V	MAX	24V	MAX	PSI	bar	PSI	GPM	LPM	GPM (min)	LPM (min)	GPH	LPH	GPH (min)	LPH (min)	TDS
Catalina 340	19.5	21.5	9.75	10.75	90-100	6.3-7	25-35	2.8	10.6	2.7	10.2	14	52.9	13.5	51.0	< 300

Poor Product Water Quality

With any product water quality issue, you must ensure accurate calibration if you are using a salinity meter. For general quality evaluation, your taste is always good enough.

Membranes are not an exact science and two identical systems can have different product quality. World health standards deem water of up to 1000 PPM of total dissolved solids acceptable for drinking. We consider any thing below 750 PPM acceptable but not ideal, and anything below 500 PPM excellent. Factors that could affect water quality are addressed below.

LOW SYSTEM FLOW OR PRESSURE will equate to lower product quality (higher PPM).

Catalina systems, which have a higher feed to output pressure ratio (See nominal pressures under Flow Test, page 45), as well as a higher feed flow/membrane area ratio, will produce water in the 150-300 PPM range.

DAMAGE TO THE MEMBRANE by chlorine contamination. Flushing the system with chlorinated water will irreparably damage the membrane. Charcoal filters are used to absorb any chlorine which might be present in flush water. They must be of proper specification to be suitable. There is no test for chlorine damage except the process of elimination of other causes.

DIRTY OR SCALED membranes. A dirty (foreign material), scaled (mineral deposits), or contaminated (bacterial growth) membrane can result in poor water quality and abnormal operating pressures. If operating pressures are above normal, then cleaning is indicated. If the system pressures are within operating normal range, cleaning may have little result. Avoid cleaning as a diagnostic tool. Low water quality after storage with propylene glycol can usually be remedied by extended flushing or an SC-2 cleaning.

MECHANICAL LEAKAGE within the membrane pressure vessel. This is an unlikely but possible cause of poor water quality. A pinched or damaged O-ring within the pressure vessel, a scratch on the product tube on the membrane, a scratch within one of the end caps, or a seal fouled by contamination could allow sea water into the product water.

If system total flow (product plus brine) is 2.7 GPM (10 liters) or above, the membrane is clean, the product flows are consistent with the system flow and the water quality is still not acceptable, then replacement of the membrane is indicated.

Technical Bulletins

The following pages include Spectra's most commonly-used technical bulletins, covering tests, adjustments, troubleshooting, and common points of confusion. Many more technical bulletins are available on the Spectra website, www.spectrawatermakers.com.

ACCUMULATOR PRESSURE

Your Catalina 340R is supplied with a pressure accumulator tank (PL-ACC-TK) installed in the feed water line between the feed pump and the Clark Pump.

The purpose of the feed line accumulator is to reduce the spikes in the feed pressure caused by the cycling of the Clark Pump. If the accumulator is not properly charged it can lead to pressure spikes and system shut down. The accumulator has a Schrader air valve, like a car tire, which allows the internal air bladder of the accumulator to be pre-charged. The accumulator should be pumped up to about 60 psi (4.1 bar) for best results. Add air using a tire pump or air compressor. You can experiment with the exact pressure that will give the best pulsation dampening on your installation.

Schrader valve



PREFILTERS

It is important to remember that your Spectra Watermaker is designed to process clean, open-ocean seawater. Any departure from that standard for your seawater intake runs the risk of causing excessive wear or damage to internal pump parts and/or the vulnerable reverse osmosis membrane. Additional prefiltration considerations and/or extremely frequent prefilter replacements may be required in any deviation from open-ocean seawater. Your local service provider or installer may have specific recommendations based on their experience with water conditions unique to your region.

Observe the seawater around your vessel. Is it clean enough to use for your seawater intake? There are several things to avoid feeding to your watermaker:

- *petroleum products, such as oil, fuel, thinners, paints, paint removers, etc.*
- *chlorine-treated water; e.g., most “dock” water*
- *silty water — water contaminated by fine, hard, suspended particulates*
- *putrid water, “red tides”, or any seawater that smells or looks contaminated*
- *harbor/marina water that you cannot see through or that shows visible signs of contaminate (neighboring boats docked nearby may be discharging contamination! Sewage, chemicals, etc.)*

Judging the quality of seawater input always involves a certain calculated risk. We know of watermaker systems that have been destroyed far offshore by intaking fresh whale excrement or oil contaminants from natural seepages. The chance of such things happening is normally small but should be considered. On the other hand, **regularly running a watermaker in an enclosed marina or harbor runs a much higher risk of harmful contamination.** If you need to test a new installation while in a marina or harbor, monitor the water quality around your vessel carefully while testing. Often times you should be able to run the watermaker safely for enough time to briefly check out the system if you are mindful of external feed conditions. If this is not possible, an artificial ocean is a useful alternative (see Page 28 for artificial ocean testing/instructions). Don't sail away without testing a new installation or repair!

During normal operation, the feed water is filtered in two stages. First it passes through a fine mesh metal sea strainer, which protects the feed pump from foreign materials and sea creatures. After passing through the feed pump, the feed water passes the filter housings containing 20 and 5 micron elements, removing very fine particles that could damage the Clark Pump and shorten membrane life. An additional carbon filter prevents the entrance of chlorine during fresh water flushing (see next page).

Prefilter maintenance schedules will vary widely depending on how and where the system is used. If large amounts of feed water are run through the system over a relatively short period of time in biologically fertile near-shore waters, the prefilters will plug up, water production and quality will drop, and the system pressure will change dramatically. In blue water conditions the prefilters may only need to be changed every week or two.

When operated for only an hour or two a day in inland or near-shore waters, the trapped plankton will begin to decay in the filters long before the elements plug up. The decaying plankton and bacteria will cause a rotten egg smell in the product water. This decay will set in overnight in tropical waters, or after a week or two in higher latitudes

PREFILTERS CONT.

Our filter element part numbers are FT-FTC-XX, where the last digits indicate the micron rating. FT-FTC-5 is for a 5 micron element, FT-FTC-20 is a 20 micron element. The optional oil/water separator is FT-FTC-OW.

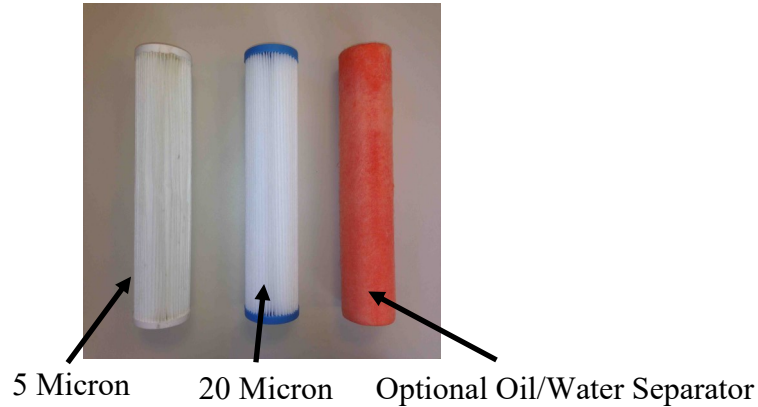

CHARCOAL FILTERS

The charcoal filter element (FT-FTC-CC) removes chlorine from the fresh water flush water supply, as the RO membrane can only handle small amounts of chlorine without permanent damage.

The charcoal filter used for the fresh water flush system will not plug up unless you have very dirty domestic water in your boat's supply tank.

The charcoal filter we supply removes 99.7% of the chlorine. Beware when buying other charcoal filters. If they don't specify the percentage of chlorine removed, don't use them. Cheap ones may remove only 60% or 70%. Also, there are aftermarket filters which are very close to, but not exactly, the right dimensions, and they will not seal in the housing. If you skimp on the charcoal filter you risk damaging a \$600.00 membrane on the first flush. The other factor is the flow rate that the filter can handle. Because the chlorine is adsorbed by the charcoal, it must remain in contact with the charcoal for a sufficient period of time for the all of the chlorine molecules to be captured. The filters we use can handle 1.5 gallons (6 liters) per minute flow, and are good for 3000 gallons (12,000 liters) at 1.5 GPM, or six months, whichever comes first. Regardless of the amount of water treated, the charcoal loses its effectiveness after six months.



Charcoal filter, Spectra part number FT-FTC-CC

Catalina 340R Wiring Schematic

Detail View: DPDT Switch Operational Schematic

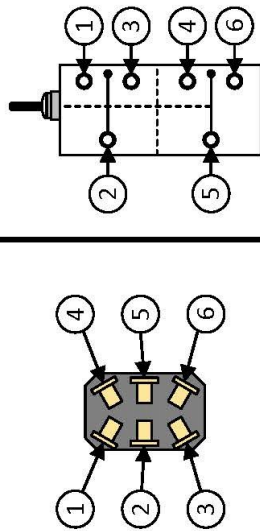

RUN (AUTO): MIDDLE – NO CONNECTIONS MADE
RUN (MANUAL): UP – PIN 2 TO PIN 3, PIN 5 TO PIN 6
RUN (SERVICE): DOWN – PIN 2 TO PIN 4, PIN 5 TO PIN 4

Detail View: SPST Relay Connection Identification

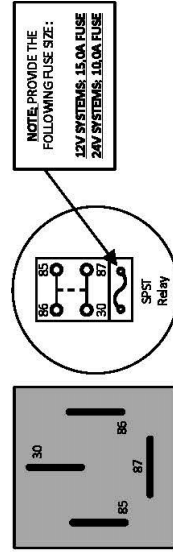

Detail View: Zion Wiring/Connection (Optional)

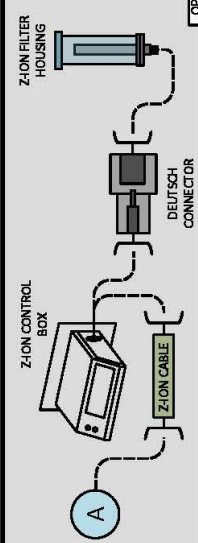

List of Symbols: KEY

	WIRE COLOR LABEL – INDICATES A BLACK WIRE
	WIRE COLOR LABEL – INDICATES A WHITE WIRE
	WIRE COLOR LABEL – INDICATES A RED WIRE
	WIRE COLOR LABEL – INDICATES A GREEN WIRE
	WIRE COLOR LABEL – INDICATES A YELLOW WIRE
	WIRE COLOR LABEL – INDICATES AN ORANGE WIRE
	WIRE GAUGE LABEL – INDICATES A GAUGE FOR A CABLE OF MULTIPLE WIRES, FORMATED AS (WIRE GAUGE) (NUMBER OF WIRES IN CABLE)
	WIRE GAUGE LABEL – INDICATES A GAUGE FOR A SINGLE WIRE
	FUSE – NECESSARY SIZING INFORMATION CALLED OUT ON WIRING DIAGRAM
	DIODE – NECESSARY SIZING INFORMATION CALLED OUT ON WIRING DIAGRAM
	COMMUNICATION PORT – CAT-5 COMM PROTOCOL CONNECTION
	WIRING – PASS THROUGH CONNECTOR – RJ-45/RI-12
	WIRING – SINGLE WIRE BLACK OR WHITE – TYPICAL COMM COLOR
	WIRING – SINGLE WIRE RED – TYPICAL ENERGIZED COLOR
	WIRING – SINGLE WIRE GREEN – TYPICAL GROUND COLOR
	WIRING – SINGLE WIRE YELLOW – TYPICAL NEUTRAL COLOR
	WIRING – SINGLE WIRE ORANGE – TYPICAL SIGNAL COLOR
	CABLING – JST AND CAT 5 PRE-FABRICATED CABLES
	NOTATION – WIRE CONTINUITY SYMBOL INDICATES CONTINUITY BETWEEN MATCHING ALPHABETIC SYMBOLS – LARGE ALPHABETIC CIRCLE

- Control System:
 Remote Manual System
 12/24VDC Input Voltage
- Applicable System Numbers:
 CT-340R-12V
 CT-340RS-12V
 CT-340R-24V
 CT-340RS-24V

Revision History: CT-340R/340RS-12/24VDC



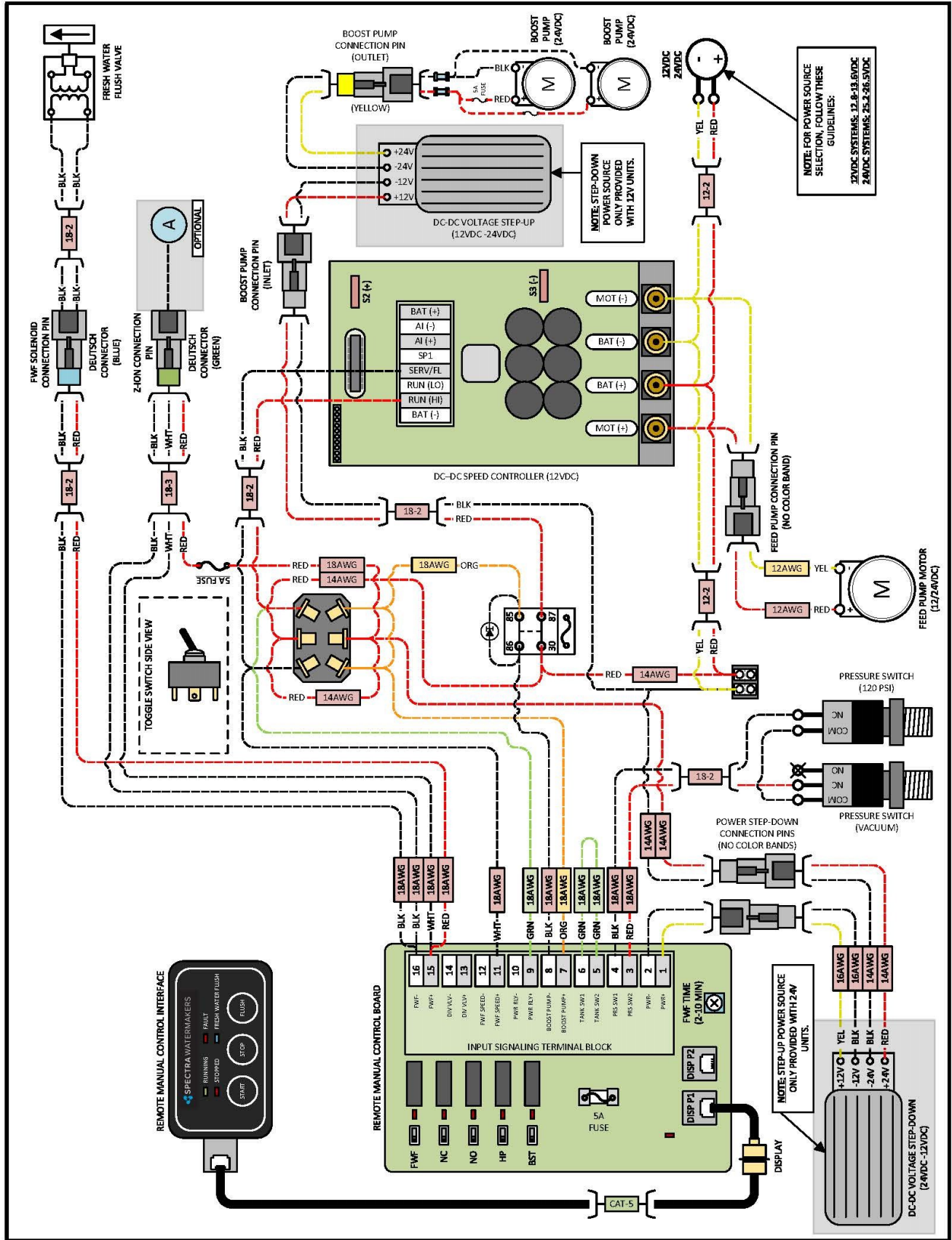

Rev. No.	Date	Description
A	09/10/2023	Initial Wiring Diagram for Remote Manual Catalina-340R/340RS Systems, 12/24VDC

Catalina 340R Wiring Schematic







Catalina 340R Electrical Specifications





Catalina 340 Remote 12V:

-  **Power Supply Voltage: 12 VDC**
-  **Bench Test: 13.8 V / 19.6 A**
-  **Power Consumption: 272 W**
-  **Efficiency: 20.1 Wh/gal**

Catalina 340 Remote 24V:

-  **Power Supply Voltage: 24 VDC**
-  **Bench Test: 27.3 V / 8.9 A**
-  **Power Consumption: 243 W**
-  **Efficiency: 18 Wh/gal**

Catalina 340 Remote W/ Short Membrane12V:

-  **Power Supply Voltage: 12 VDC**
-  **Bench Test: 13.9 V / 19.8 A**
-  **Power Consumption: 275 W**
-  **Efficiency: 20 Wh/gal**

Control Box Wiring

Multiple Display Ports

Switches for Relays 7-13

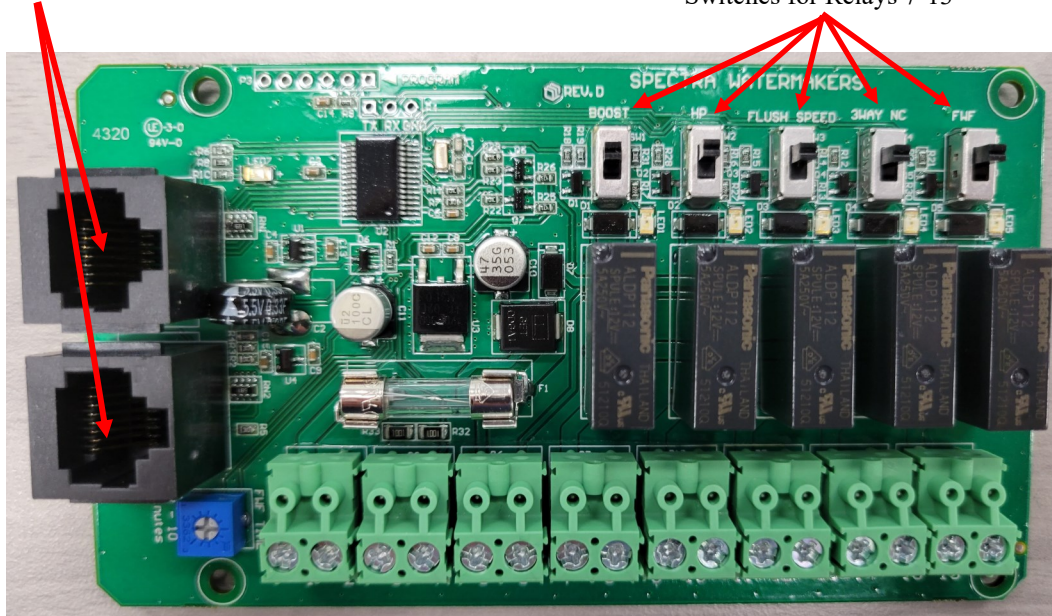

1. PWR IN+	5. TANK SW	9. PWR RELAY+	13. D.V.+
2. PWR IN-	6. TANK SW	10. PWR RELAY-	14. D.V.-
3. PRS. SW 1+	7. BOOST PUMP+	11. FWF SPEED+	15. FWF+
4. PRS SW 2-	8. BOOST PUMP-	12. FWF SPEED-	16. FWF-

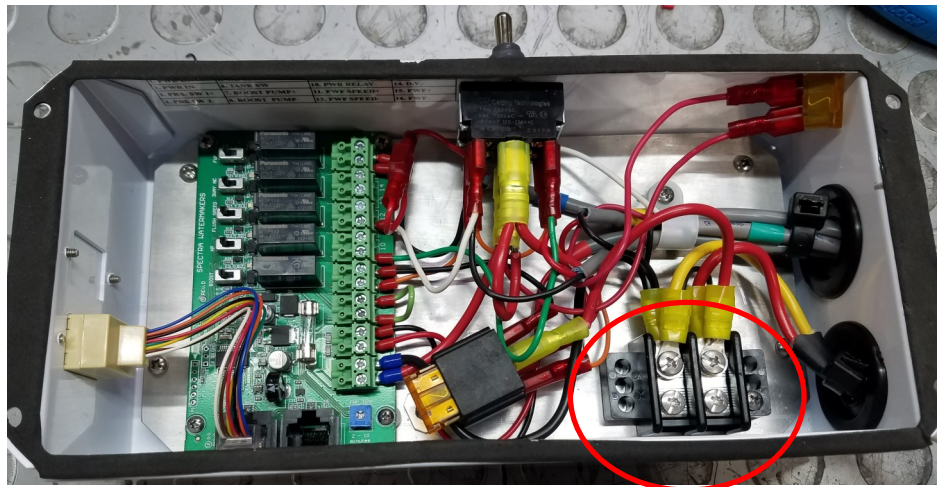

Main Power
Connection Terminal
Block

Optional Z-Ion Protection System

The Z-Ion, developed by Spectra, protects the entire system from fouling for extended periods without fresh water flushing or storage chemicals (pickling).

The Z-Ion achieves this end by introducing a stream of metallic ions into the fresh water flush water, thus flooding the entire system with ions that prevent biological growth for up to thirty days. If you are going to let your system sit idle for longer than thirty days, you will still need to treat it with SC-1 storage chemical or propylene glycol.

The Z-Ion will not prevent freezing, so in freezing climates pickling with propylene glycol is still required. Even with the Z-Ion there may still be cases when you need to pickle your system with SC-1 storage chemical or propylene glycol, so we recommend you carry one of these products at all times.

If your system was ordered with the Z-Ion, it will require only some basic wiring and commissioning, laid out in the following pages.

If you didn't order your system with the Z-Ion, it can be retrofitted to any Spectra system.



NOTE: Contact Spectra for more information at: techsupport@spectrawatermakers.com

Z-Ion Installation

If you ordered your system with a Z-Ion, the feed pump module will come with the Z-Ion installed in place of the standard fresh water flush module, as shown, with a separate Z-Ion electronic control box:

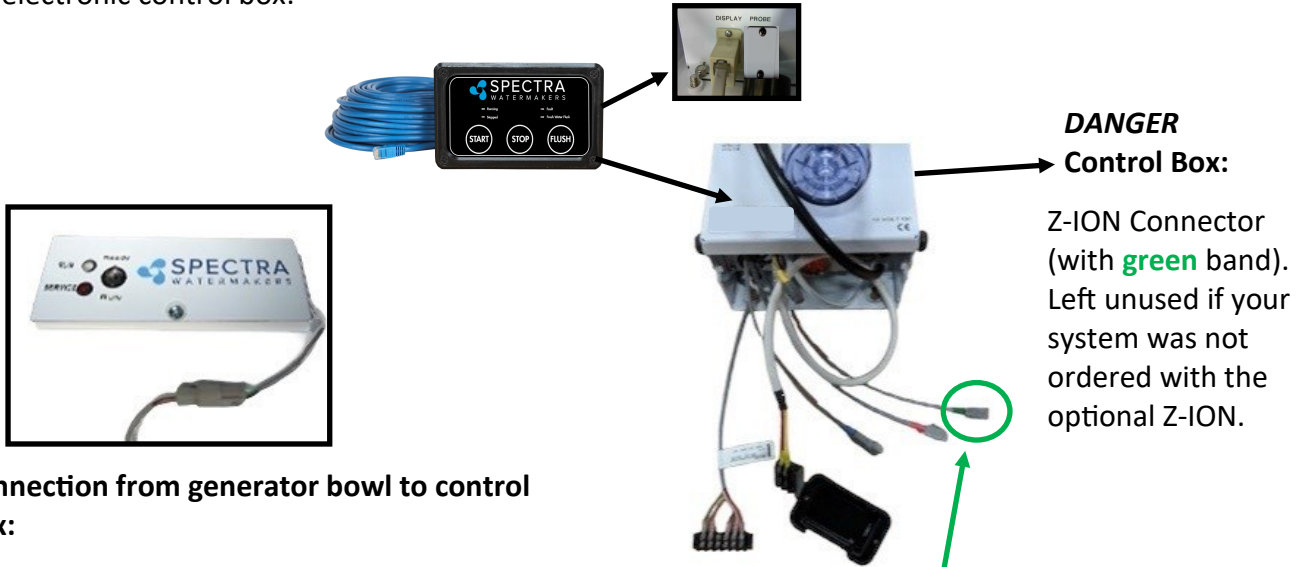

Connection from generator bowl to control box:

The pigtail from the control box has a water-tight connector, which connects to the pigtail from the generator bowl:

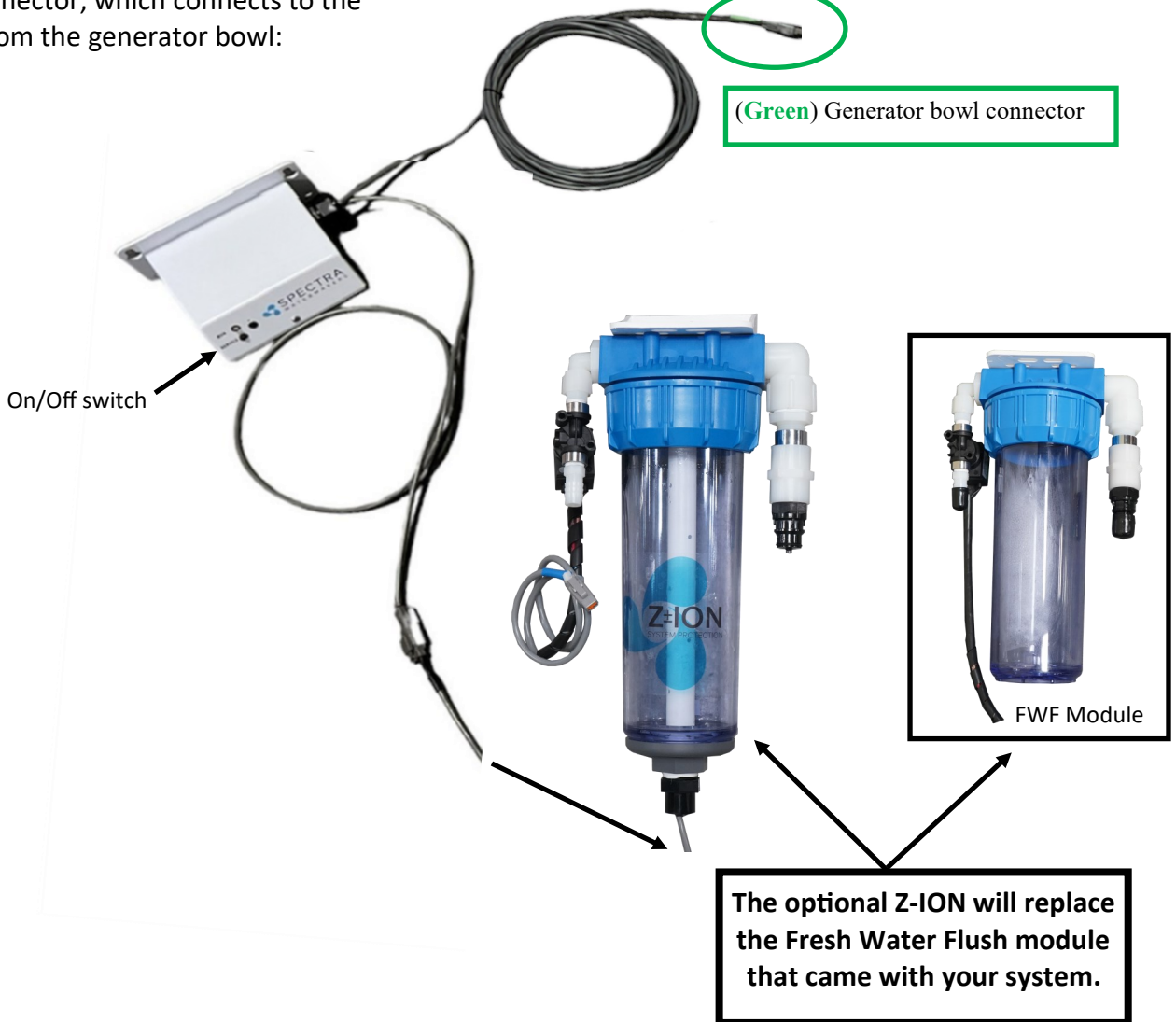

Z-Ion Operation

The Z-Ion should be energized at all times, but will only consume power when operating. Upon initial power-up the LED will flash red/green and then will turn solid green.

Follow the instructions for Normal Operation and Fresh Water Flush. For treatment with the Z-Ion, the process is identical, only the Z-Ion will release silver and copper ions into the flush water when you turn on the generator with the on/off switch. Turn on the ion generator at the same time that you open the flush valve.

The operation cycle begins and the LED will flash green/amber. The cycle will continue until you turn off the ion generator or the adjustable timer times out (factory set for 15 minutes).

Turn off the ion generator at same time that you close the flush valve. If you forget to turn off the ion generator, the Z-Ion will time out after 15 minutes, so no harm will be done to the unit.

If the voltage is out of range, below 10V or above 56V, the LED will flash red every two seconds and the unit will shut down.

Each fresh water flush with the Z-Ion will protect your watermaker for up to 30 days, after which the process must be repeated.

After 720 cycles the service light on the front of the control box will light up, indicating that the probes on your Z-Ion may be wearing down, and should be tested. The service light is just a reminder, and the Z-Ion will go on functioning while it is lit.



DANGER: To reset the service counter, touch two magnets, at the same time, to the two red reed switches on the Z-Ion circuit board, labeled Switch 1 and Switch 2 below.

Z-Ion Circuit Board Layout

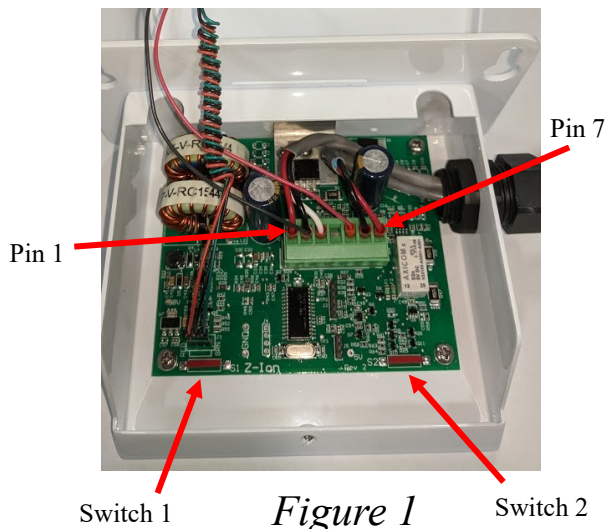

Figure 1

Z-Ion Operation – LED Status Lights & Pinout Info

- Power-up indication – *Fast red/green flash for a few seconds*
- Ready/Idle – *Solid green*
- Generating (during a flush) – *The LED will quickly flash at a programmed interval (factory set to 17 seconds between flashes) The flash color will alternate between green and amber and will be off in between voltage spikes. The color change symbolizes the polarity alternating from positive to negative.*
- Bad power – *Fast red flash followed by shut down*
- High temperature – *Fast red flash*
- Service/Cycle Counter Limit - *Slow red flash*

There are 7 pins on the phoenix connector from left to right in Figure 1.

Pin 1 Supply Voltage- Battery (+)	Pin 4 Auxiliary Output 1
Pin 2 Ground	Pin 5 Auxiliary Output 2
Pin 3 Trigger	Pin 6 To Zion generator (bowl). No polarity.
	Pin 7 To Zion generator (bowl). No polarity.

Exploded Views and Part Numbers

High Pressure Module

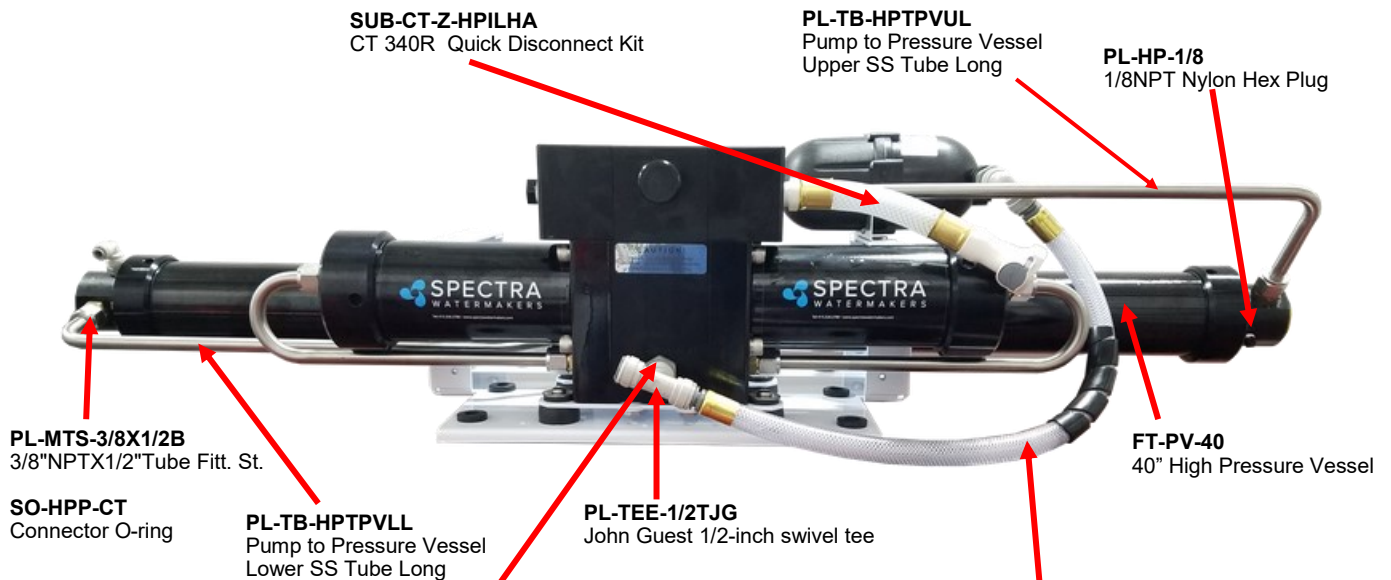

PL-STA-12Tx38NJ
 1/2"Tube Stem x 3/8" NPT
 adapter John Guest

Accumulator Hose:
 20 inches 1/2-inch vinyl hose **PL-HS-1/2VN**
 (2) brass ferrules **PL-HF-.75IDX1BR**
 (2) 1/2-inch hose barb tube adapters **PL-HBA-1/2Tx1/2**
 5 inches of 3/4-inch spiral wrap **EL-LT-3/4SW**
 Hose clamps may be substituted for the brass ferrules,
 which are crimped on.

Accumulator

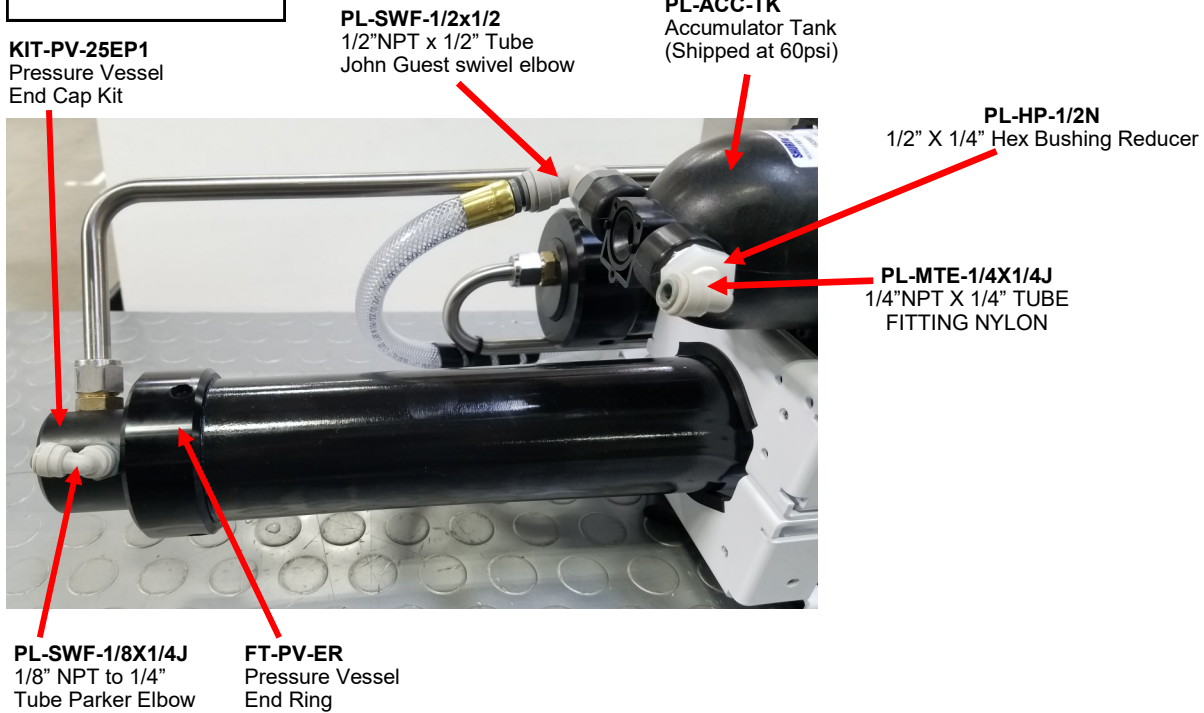

Part Numbers

Feed Pump Module

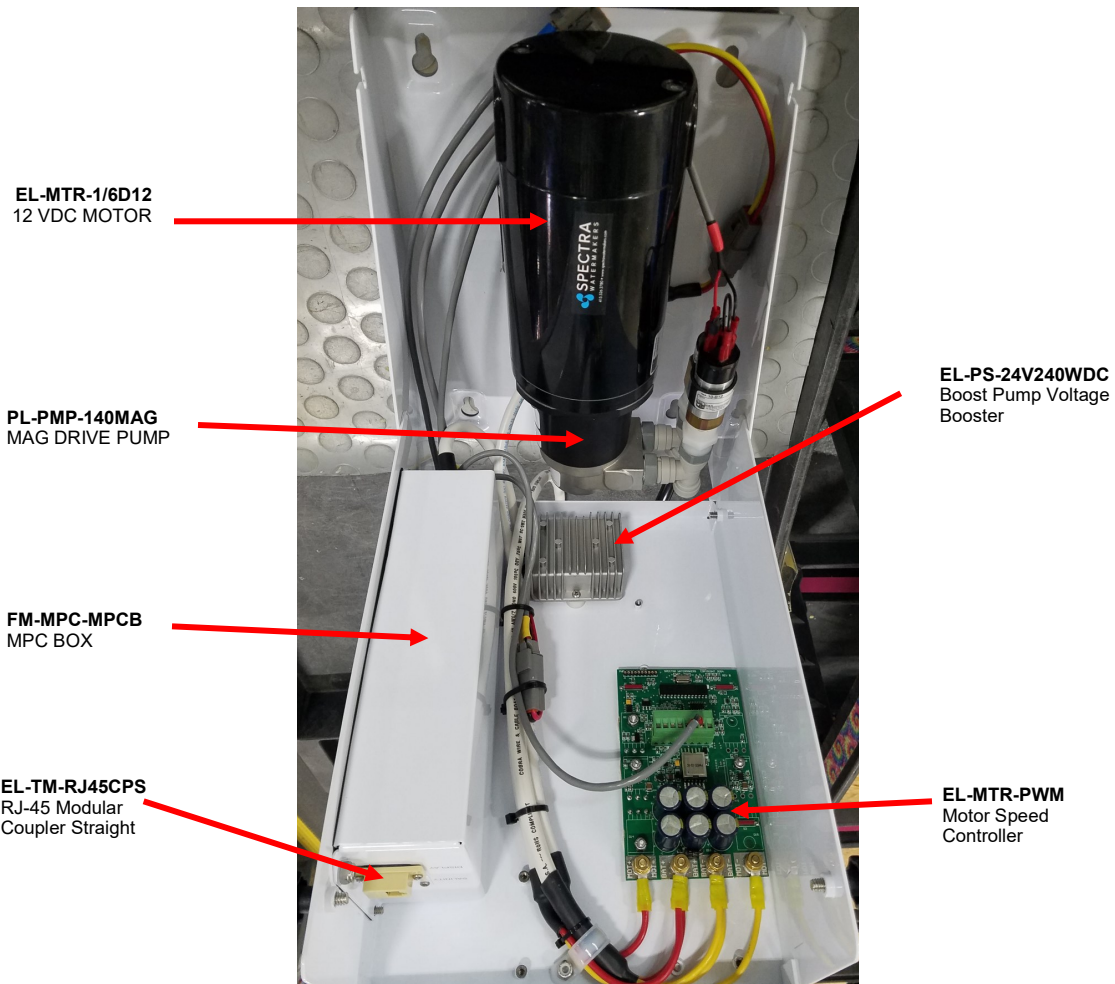
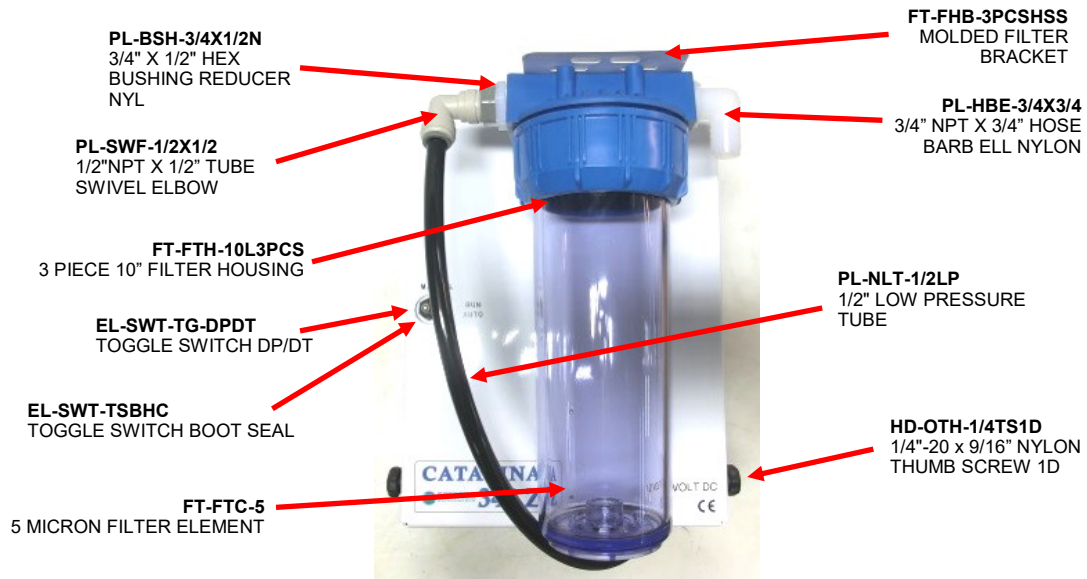

Part Numbers

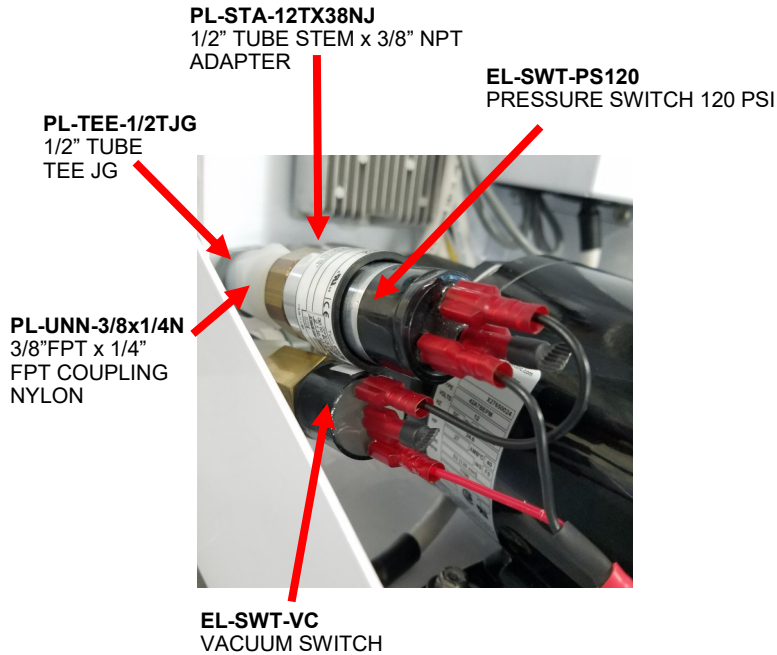

KIT-REM-RMC SPECTRA MANUAL REMOTE CNTRL. KIT



SUB-MD-PNLA380 REMOTE GAUGE PANEL ASSEMBLY KIT

Hoses and Tubes

Inlet/Flush Hose Assembly (SUB-CT-Z-HPIBHA):

Brass ferrules for 1/2-inch hose (PL-HF-.75IDX1BR)



Note: Hose clamps may be substituted for brass ferrules, which require a special crimper.

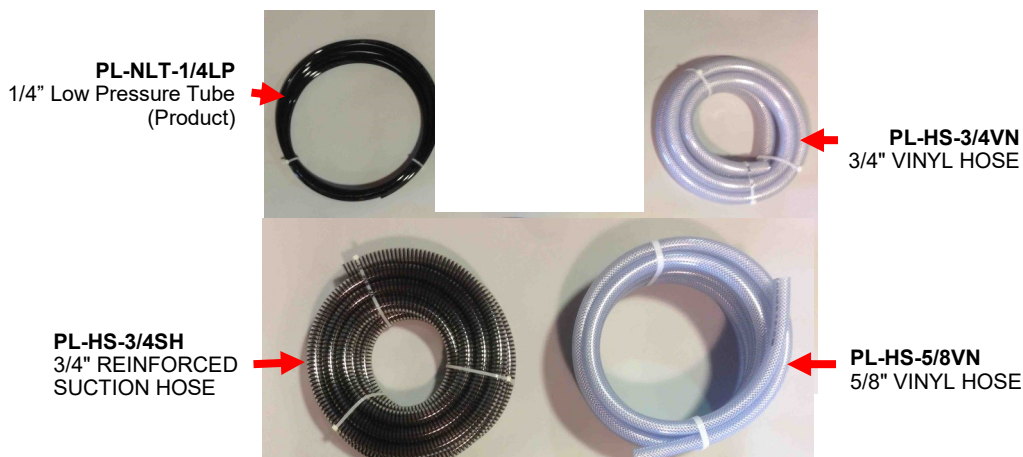

Parts I.D.

Fresh Water Flush Module



Note: The Fresh Water Flush module without Z-Ion will have the same parts, minus the modified filter bowl, sticker, and control box.

Z-ION Configured Fresh Water Flush Module

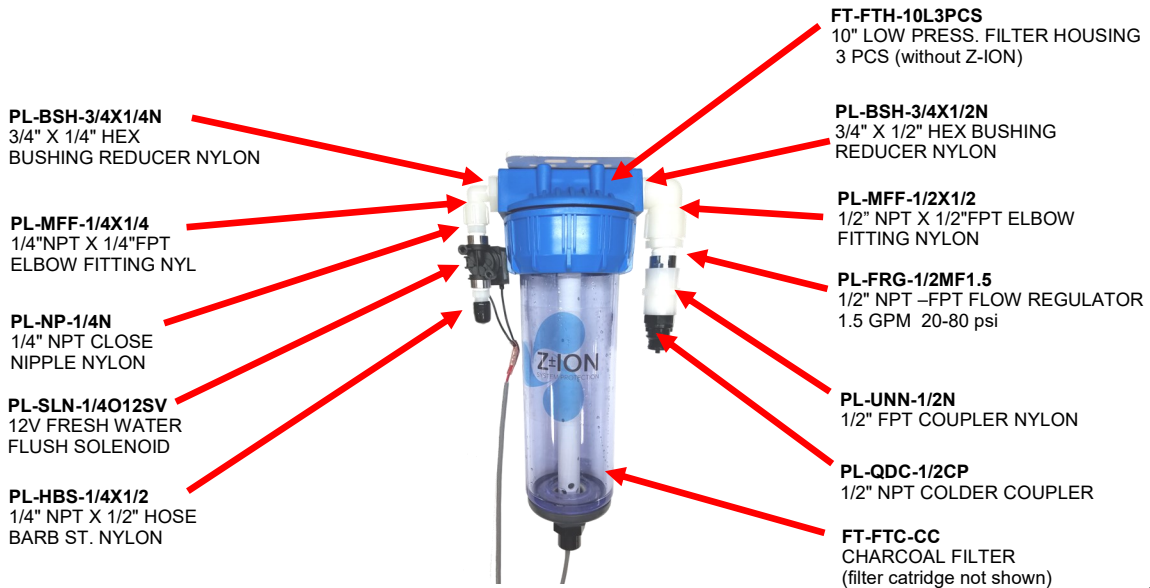

Not Pictured: Z-ION Control Box

Parts I.D.

Sea Strainer & Boost Pump Module KIT-NP-M2Z-SBPH

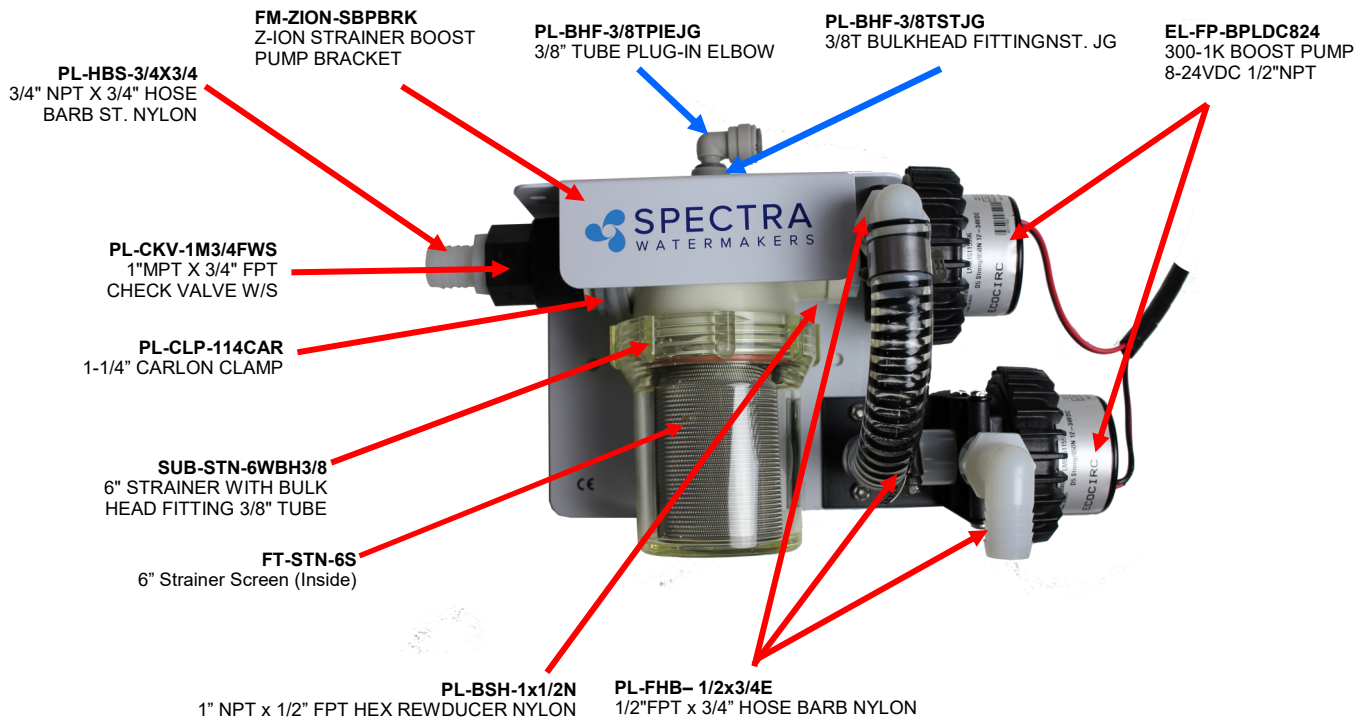

Not pictured here:
EL-FUS-15AMICHD 15A MICRO FUSE HOLDER
EL-FUS-5AMIC2 5A MICRO2 FUSE

Raw Plastic Sea Strainer



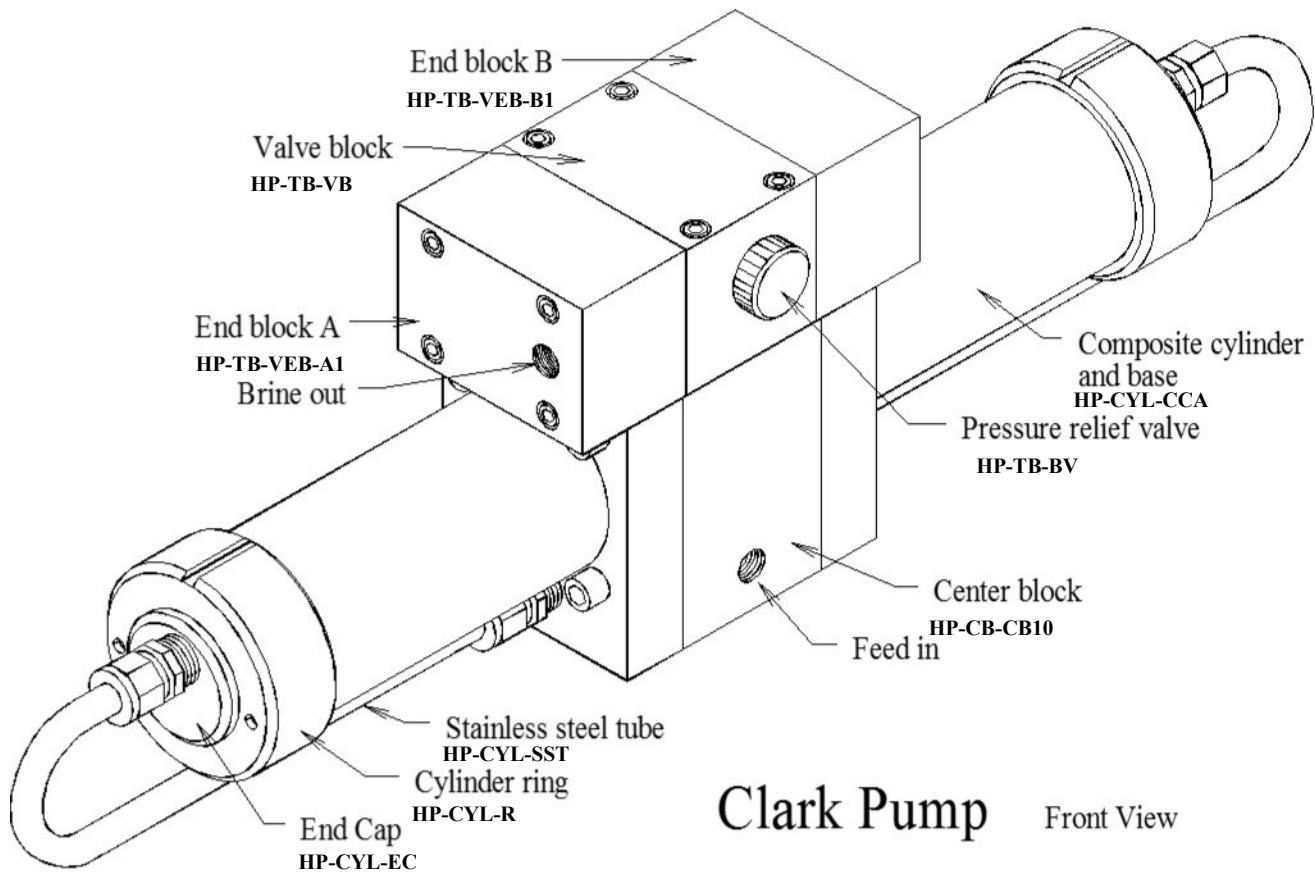

Clark Pump Front View

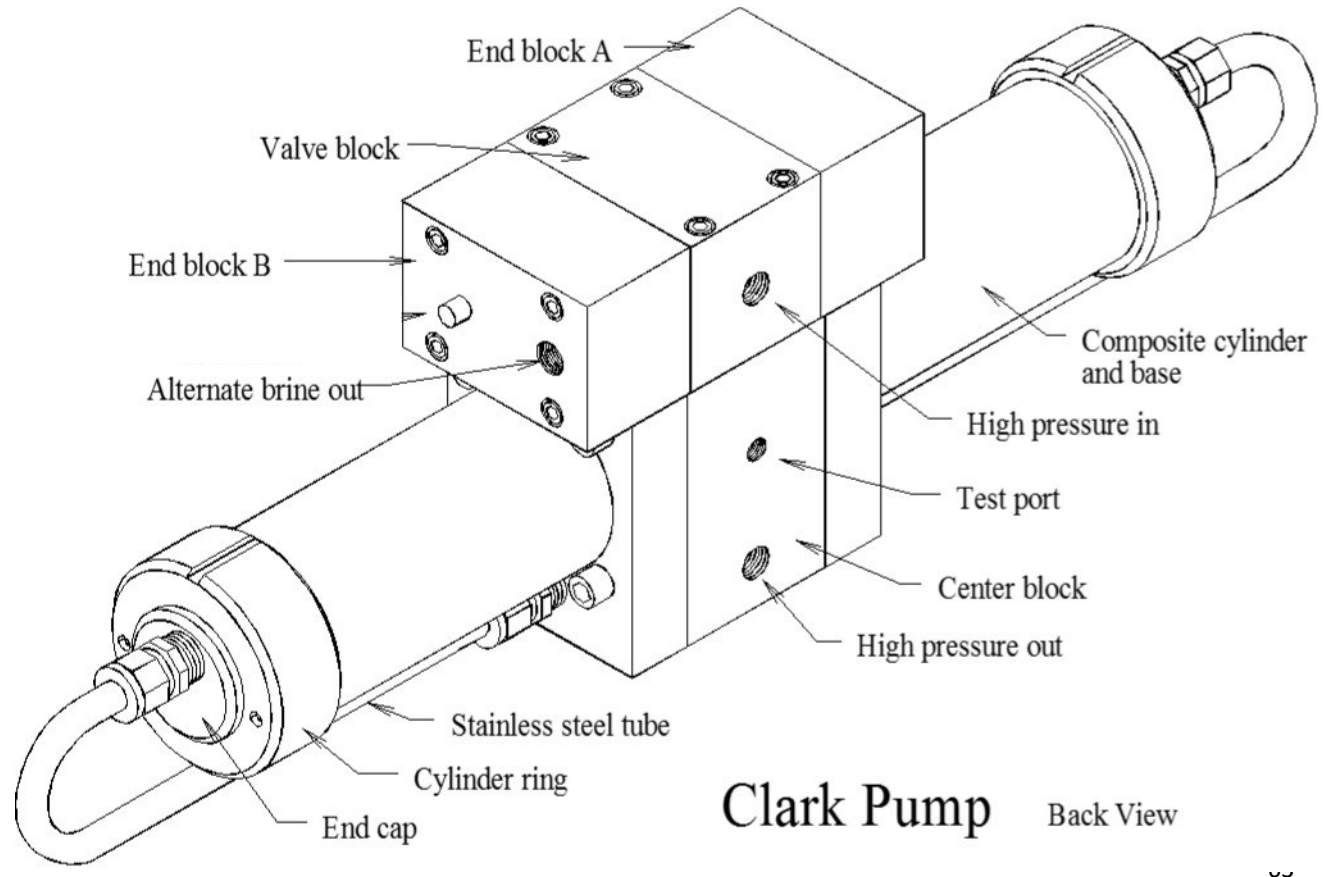

Clark Pump Back View

Spool Assembly
Exploded View

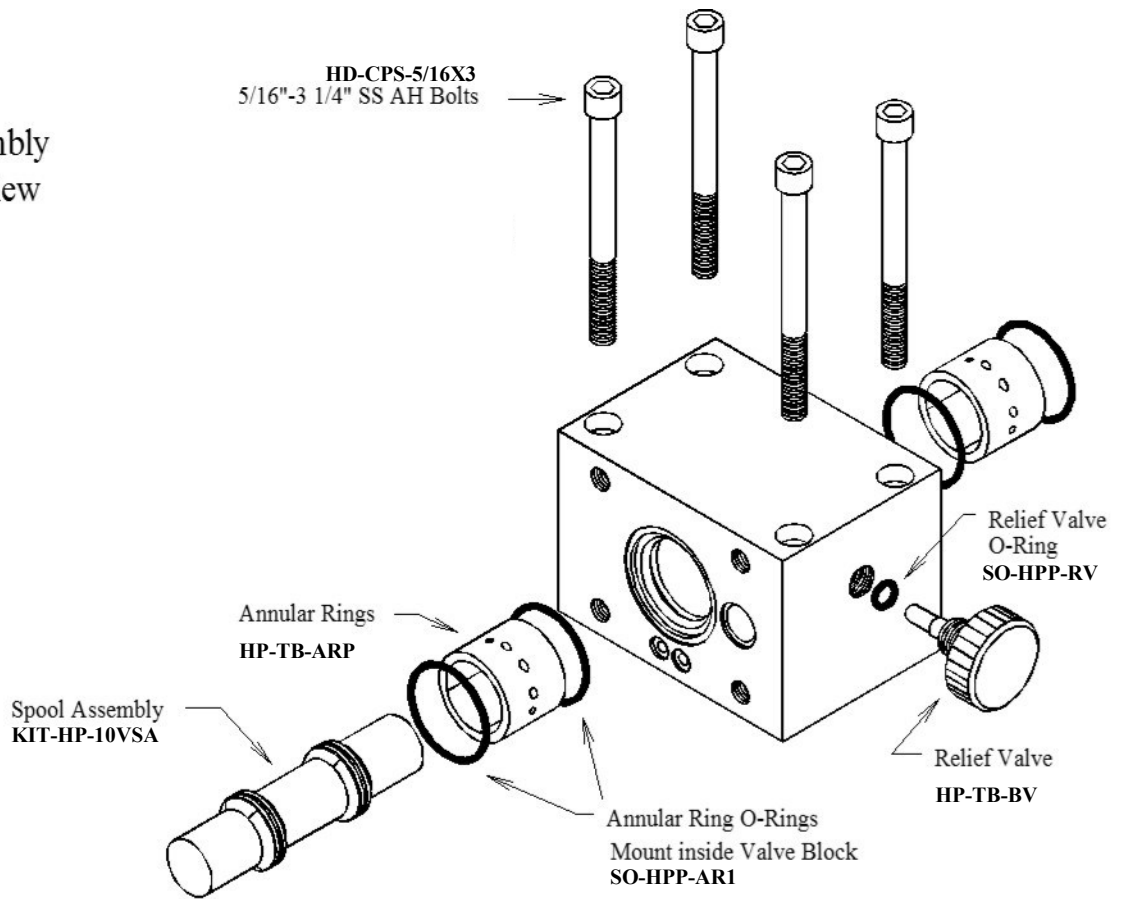

Valve Block

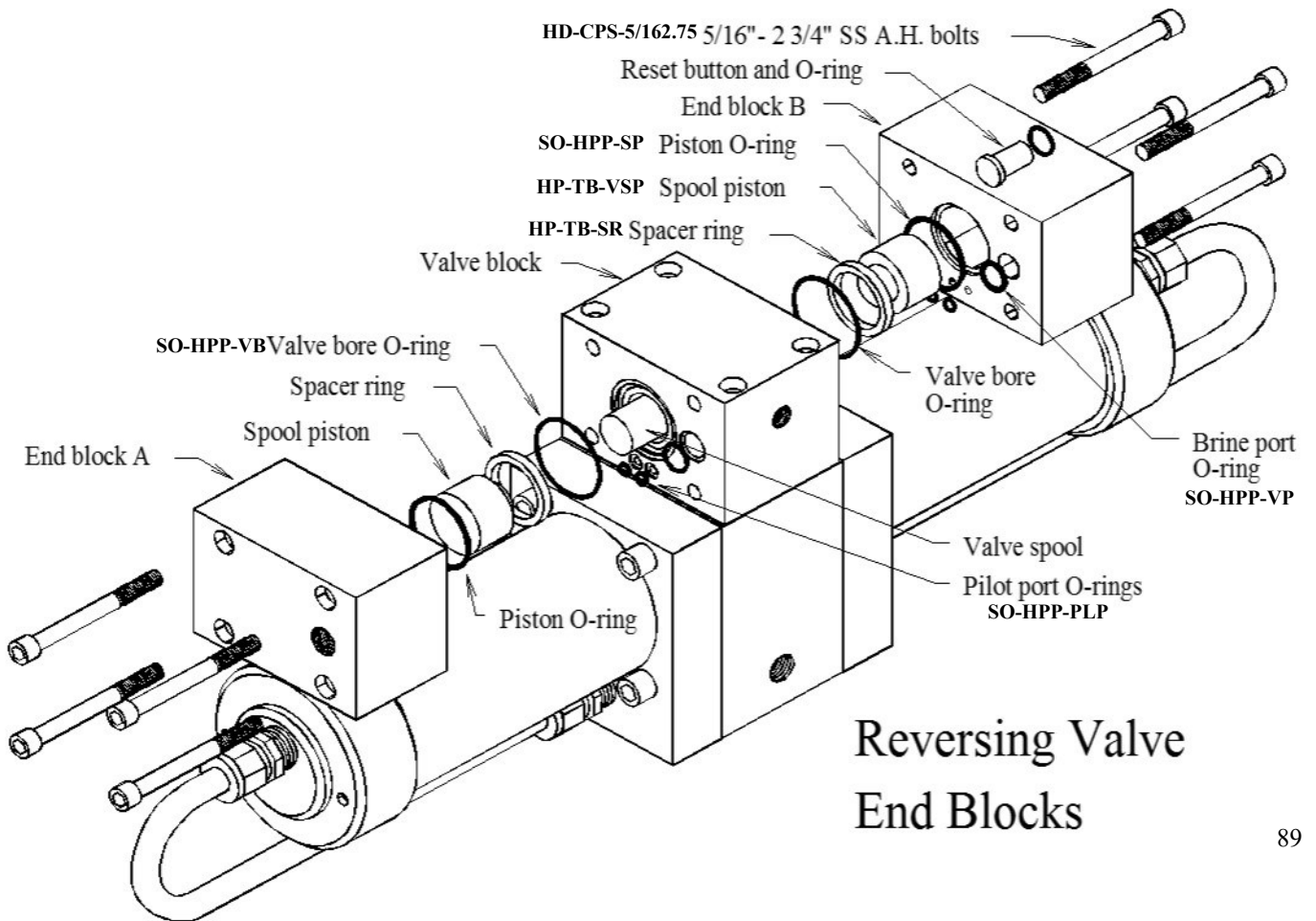

Reversing Valve
End Blocks

Parts

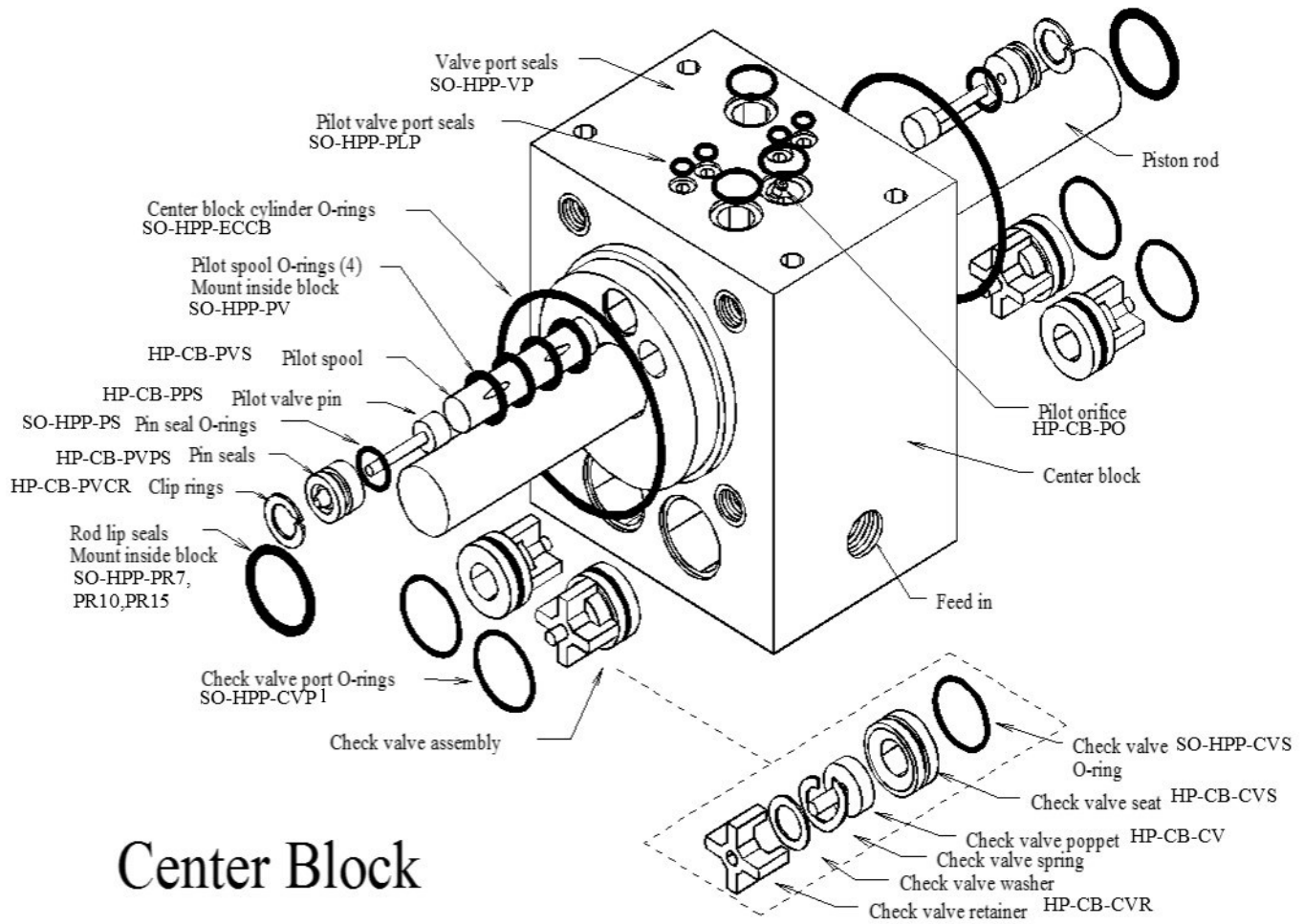

Center Block

Parts

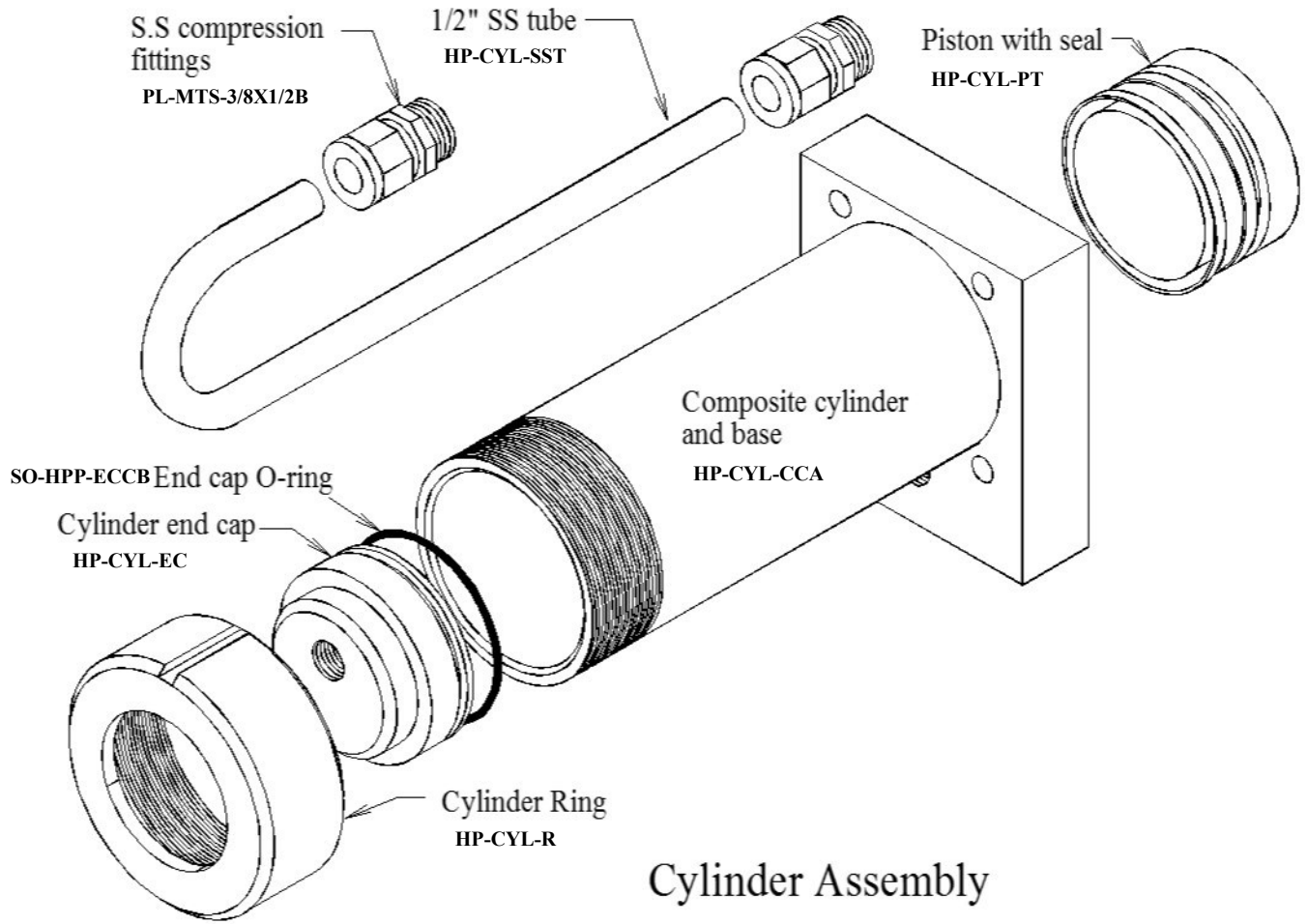

Spectra Watermakers. Making fresh water worldwide.

Spectra Watermakers is a Katadyn Group Brand.

KATADYN GROUP
SWITZERLAND

SPECTRA WATERMAKERS

SPECTRA WATERMAKERS LIMITED LIFETIME WARRANTY

THIS LIMITED WARRANTY APPLIES TO THE ORIGINAL OWNER OF THE WATERMAKER AND IS NOT TRANSFERRABLE

For warranty information regarding products sold within the European Union please contact europe@spectrawatermakers.com.

This limited product warranty is provided by Katadyn Desalination LLC, a Business Unit of the Katadyn Group. (“Manufacturer” of “We” or “Our”) to the original, consumer owner of the product (“You” or “Your”) with which this limited product warranty is provided (the “Product.”)

The Manufacturer warrants to You that the product will be free from defects in material and workmanship under normal use and regular service and maintenance, subject to the exclusions described below, for a period of 1 year (the “Warranty Period”) after date of installation, or 15 months after the shipment date, whichever comes first. This warranty will be extended for an additional 12-month period when the product is installed and commissioned by a Katadyn Desalination Authorized Installer. A Spectra Watermakers Commissioning Report must also be returned and approved by the factory. The Spectra Clark Pump has a Limited Lifetime Warranty on Marine systems to the original consumer owner of the product, not inclusive of repair or replacement parts due to wear over time. If the Spectra Clark Pump is used in a Landbased application, the product warranty is provided for a period of 1 year (the “Warranty Period”) after date of purchase (if purchaser is installing system) or date of commissioning (if Spectra dealer is installing system).

You will be required to show written documentation supporting the date of purchase or date of commissioning. If you are unable to provide documentation supporting the date of purchase or commissioning, the warranty period shall be based on the product’s date code and will be determined by the Manufacturer’s sole and absolute discretion.

WHAT IS COVERED

Katadyn Desalination LLC. warrants, for the period defined above, that the Product will be free from defects in materials and/or workmanship and will conform to Manufacturers published specifications if installed and maintained in accordance with the Manufacturers Instructions.

WHAT IS NOT COVERED

The Warranty does not include service, repair, or replacement to correct damage caused by improper installation, maintenance, improper connection with water systems, external electrical fault, accident, alteration, misuse, abuse, neglect, negligence, (other than Manufacturer’s), acts of God, failure to install or maintain the product in accordance with the Manufacturers instructions.

DAMAGED OR MISSING PRODUCT

You must examine the Product upon receipt and notify Katadyn Desalination LLC. if any item is damaged or missing within 30 days from the date of the delivery. Damage due to freight must be reported to Katadyn Desalination LLC. and to the freight carrier within 24 hours of delivery.

SOLE WARRANTY

THE WARRANTIES SET FORTH IN THIS SECTION ARE THE SOLE AND EXCLUSIVE WARRANTIES GIVEN BY THE MANUFACTURER WITH RESPECT TO THE PRODUCTS AND ARE IN LIEU OF AND EXCLUDE ALL OTHER WARRANTIES, EXPRESS OR IMPLIED, ARISING BY OPERATION OF LAW OR OTHERWISE, INCLUDING WITHOUT LIMITATION, MERCHANTABILITY AND FITNESS FOR A PARTICULAR PURPOSE WHETHER OR NOT THE PURPOSE OR USE HAS BEEN DISCLOSED TO MANUFACTURER IN SPECIFICATIONS, DRAWINGS OR OTHERWISE, AND WHETHER OR NOT MANUFACTURER'S PRODUCTS ARE SPECIFICALLY DESIGNED AND/OR MANUFACTURED BY MANUFACTURER FOR YOUR USE OR PURPOSE.

WHAT WE WILL DO TO CORRECT PROBLEMS

If You return the defective product during the warranty period and in accordance with the instructions contained herein, shipping prepaid, the Manufacturer shall, at its option and as Your exclusive remedy, repair, correct or replace the product at no charge if the product is found by the Manufacturer to be a valid warranty claim, in Manufacturer's sole discretion. Replacement product may be refurbished and/or different models but will be functionally equivalent to the product or hardware being replaced. Product repaired or replaced during the warranty period shall be covered by the foregoing warranty for the remainder of the original warranty period or ninety (90) days from the date of shipment or purchase, whichever is longer. Contact your Dealer or the Manufacturer's Customer Service at 415-526-2780 to obtain a returns materials authorization (RMA #).

HOW TO MAKE A WARRANTY CLAIM

If You discover any warranty related issues after 30 days, or You have questions concerning Your product or how to determine when service is needed, please contact your local dealer or contact the Manufacturer's Technical Support at 415-526-2780 or email the Manufacturer at techsupport@spectrawatermakers.com. The following information must be provided as part of Your warranty claim: your name, address, phone number, Your products' model number, Your product's 4-digit serial number, and if necessary, upon request, written confirmation of the date shown on Your purchase receipt and the purchase price paid for the product. All products being returned to the Manufacturer must have a return material authorization (RMA) number to be processed. Any item returned to the Manufacturer without an RMA number will not be accepted by the Manufacturer. Contact your Dealer or Customer Service to obtain an RMA number. Once we have received Your returned product, we will determine, in our sole and absolute discretion, whether Your claim is covered by, or excluded from, this limited warranty. Repairs or modifications made to the product by other than the Manufacturer will nullify this limited warranty. Coverage under this limited warranty is conditioned at all times upon the original purchaser's compliance with these required notification and repair procedures.

LIMITATION OF LIABILITY TO THE FULLEST EXTENT PERMITTED BY LAW, IN NO EVENT, SHALL MANUFACTURER OR ITS AUTHORIZED SERVICE REPRESENTATIVES BE LIABLE FOR ANY INCIDENTAL, SPECIAL, INDIRECT, OR CONSEQUENTIAL DAMAGES, INCLUDING ANY ECONOMIC LOSS, WHETHER RESULTING FROM NONPERFORMANCE, USE, MISUSE OR INABILITY TO USE THE PRODUCT OR THE MANUFACTURER'S OR ITS AUTHORIZED SERVICE REPRESENTATIVE'S NEGLIGENCE. THE MANUFACTURER SHALL NOT BE LIABLE FOR DAMAGES CAUSED BY DELAY IN PERFORMANCE AND, IN NO EVENT, REGARDLESS OF THE FORM OF THE CLAIM OR CAUSE OF ACTION (WHETHER BASED IN CONTRACT, INFRINGEMENT, NEGLIGENCE, STRICT LIABILITY, OTHER TORT OR OTHERWISE), SHALL MANUFACTURER'S LIABILITY TO YOU EXCEED THE PRICE PAID BY THE ORIGINAL OWNER FOR THE MANUFACTURER'S PRODUCT.

The term "consequential" damages shall include, but not be limited to, loss of anticipated profits, business interruption, loss of use or revenue, the cost of capital or loss or damage to property or equipment. Some states do not allow the exclusion or limitation of incidental or consequential damages, so the above limitation may not apply to you. This limited warranty gives you specific legal rights, and you may also have may other rights which vary from State to State.

--- CUT HERE ---

Spectra Product Registration Form

Any commissioning/install report (and additional 12 month warranty) may be rejected at the sole discretion of Spectra Watermakers if the system is not installed correctly.

Registration (To be completed by owner)

System Details:

Model _____ Date of install: _____
4-digit S/N _____ Clark Pump S/N: _____ Voltage _____
Dealer/distributor: _____ Boat Location: _____ max speed: _____

Boat model or type (i.e. Leopard 44, Beneteau 55' powerboat, catamaran, powercat, 42' sailboat...)

What type of boating will you be doing and what will the watermaker primarily be used for:

Original Owner Details:

Name: _____ Phone Number: _____
Email Address: _____
Address (Optional): _____

Submission for Approval:

Please submit this document along with the Installation and Commissioning Reports to Spectra Watermakers for approval. Submissions can be **submitted online**, scanned and emailed, or mailed directly to the factory. Spectra Watermakers Technical Support will email the original owner and the authorized distributor with the status of submission.

Web-Based Format (Preferred option):

spectrawarranty.formstack.com/forms/product_registration
spectrawarranty.formstack.com/forms/spectra_install_commissioning_report

Email: TechSupport@SpectraWatermakers.com

Phone: +1(415) 526-2780

Address: Katadyn Desalination
Technical Department
2220 S. McDowell Blvd Ext
Petaluma, CA 94954
USA

Please keep a copy of these reports for your records.

--- CUT HERE ---

Spectra Watermakers Installation Report

(To be completed by authorized installer)

The following checklist is designed to confirm that the watermaker installation meets Spectra standards. Fill out the checklist as completely as possible. Check any boxes that apply and note any concerns. Please document any discrepancies or concerns with photos.

INLET

- Inlet Seacock is below waterline
- Inlet Seacock is dedicated
- Inlet Seacock is shared
- Inlet Thru-Hull forward facing scoop
- Has strainer
- Has diving snorkel
- Has sea chest
- Other

Thru Hull Size: _____ IN/CM

Approximate location on vessel and notes: _____

SEA STRAINER/BOOST PUMP MODULE

- Module is below waterline
- Clearance for filter sea strainer servicing

Notes: _____

FEED PUMP MODULE

- Feed pump module is mounted upright
- Clearance for filter cartridge changes
- Intake hoses are free of kinks

Distance from waterline: _____ FT/M above /below the waterline

Hose length from boost pump module: _____ FT/M

HIGH PRESSURE MODULE and BRINE DISCHARGE

- Pressure relief valve is accessible
- Brine discharge has no obstructions and vents to atmosphere

Notes: _____

PRODUCT WATER TUBING

- Product water flows into top of freshwater tank
- Freshwater tank is vented

Notes: _____

INSTALLATION SIGN OFF

Technician's Name: _____ Date: _____

Technician's Signature: _____

Distributor/Dealer _____

--- CUT HERE ---

Spectra Watermakers Commissioning Report – Page 1

(To be completed by authorized installer)

The following checklist is designed to confirm that the watermaker installation meets Spectra standards and that the system is performing at specification.

Fill out the below checks as completely as possible. Check any boxes that apply and note any concerns.

PURGE

- Storage Chemicals have been purged with PRV open

Length of purge: _____ Minutes

- Diversion Valve is up, in reject position
- Filter condition has been calibrated
- "Run Manual" switch engages full speed
- "Service" switch engages flush speed

RUN HIGH MODE CHECKS

Product Flow: _____ GPH/LPH

Confirmed Product Flow Rate _____ GPH/LPH

- Technician Flow meter. Brand _____
- Hand Measurement _____ Gal/Liters in _____ SEC/MIN

Product Quality: _____ PPM

- Confirmed product quality with handheld TDS meter

Feed Pressure: _____ PSI/BAR

Boost Pressure (with clean prefilters): _____ PSI/BAR

Brine Flow Rate: _____ GPM/LPM

Measurement taken with:

- Technician Flow meter. Brand _____
- Hand Measurement: _____ Gal/Liters in _____ SEC/MIN
- Boost Pump runs
- Output and motor speed decrease when low mode is engaged

Notes: _____

FRESHWATER FLUSH

- Freshwater Flush solenoid valve opens
- Feed Pump is not cavitating when system flushes with seacock closed

Ship's pressurized freshwater pump flow & pressure rating _____ GPM/LPM _____ PSI/BAR

When seacock is open, what is the ppm of brine discharge at the end of the flush _____

Flush duration is _____ Minutes

- Needed to change flush time
- Needed to change speed of feed pump during flush

Notes: _____

*If the system does not have a dedicated forward-facing scoop type thru-hull or will be on a vessel that moves faster than 15 knots the system needs to complete the following sea trial checks. Spectra Watermakers reserves the right to require a sea trial from any customer before approving a commissioning report.

SEA TRIAL

- Watermaker will flush while underway
- Watermaker will start while underway

While the vessel is underway moving _____ KNOTS/MPH/KPH the watermaker is producing _____ GPH/LPH at _____ PPM

Spectra Watermakers Commissioning Report – Page 2

OWNER EDUCATION

Owner has been trained on the following:

Know locations of

- Seacock/Thru-hull
- Sea strainer module
- Prefilter (and/or) Feed Pump Module
- Freshwater Flush Module
- High Pressure Module
- Clark Pump Pressure Relief valve
- Product water inlet to Freshwater Tank
- Brine Discharge location
- Service hoses and storage chemicals
- User Manual

- How to power the watermaker off and on at the main breaker.
- How to run the watermaker.
- How to freshwater flush and the importance of freshwater flushing.
- Knows when the ships domestic freshwater pump is on.
- Knows which prefilter cartridges to use and how to change them.
- Knows how to service the sea strainer module.
- Knows where the carbon block filter is and is familiar with (6 months) service frequency.
- Knows how to run the system via "RUN MANUAL." Including knowing how to bypass the diversion valve and sample the product water before it enters the tank.
- Understands the risks of running the system in run manual.
- Have visually seen the overboard brine discharge (Should know when the system is pumping water).
- Know where freshwater enters the tank, would be able to manually sample/taste water if necessary.
- Understand when the Clark Pump is under pressure and cycling.
- Has felt the boost pump when the system is on and when the system is off.
- Understand the relationship between the boost pump and filter condition as well as feed pump health. Note the filter condition change when boost pump cable is disconnected.
- Be able to identify feed pump cavitation (this is the sound the feed pump makes when the system is running, and the seacock is closed momentarily.)
- Have seen how the service hoses and bucket are used to circulate seawater or freshwater through the system.
- Have heard the difference speeds of the vane pump (the difference between Run Hi and Service speed.)

Notes: _____

<p>COMMISSIONING REPORT SIGN OFF</p> <p>Technician's Name: _____</p> <p>Technician's Signature: _____</p> <p>Owner's Name _____</p> <p>Owner's Signature _____</p>
